



Galtech

CANADA INC

Sepehr Hydraulic Asia



Gear pumps and motors

Monoblock and sectional valves

Hydraulic components and accessories



OMIT

PH
POCLAIN HYDRAULICS

MTC
HYDRAULIC VALVES

APSCO Inc.

C3F hydraulic

VERSO DE LA COUVERTURE
NE PAS IMPRIMER

TABLE OF CONTENTS

ACCESSORIES & FILTERS

Breather cap	page 25
Suction strainer	page 26
Return filter	page 27
Level gauge c/w thermometer	page 25
Bell housing for gas/electric motor	page 26
Spin-on filter head & element	pages 26, 27

ADAPTORS

90 degrees swivel	page 24
Straight swivel	page 24

PNEUMATIC CONTROLLERS

Dump pump/PTO pneumatic valve	page 19
Joystick & pneumatic valve AV295, VM-7, VM-10	page 19
Pneumatic/electric controller	page 17

HYDRAULIC PUMPS & MOTORS

Galtech group 1, 2, 3, gear pump	pages 7, 8
Manual pump	page 10
Low speed high torque motor	page 18
Speed increaser & DC clutch	page 27
Hybel Hydraulic Serie 12 gear pump	page 9
Webster YC & KB gear pump	page 9

ACCESSORIES VALVES

Inline flow control	page 23
Needle valve	page 23
50/50 flow divider/combiner	pages 12, 15
Adjustable flow controls, pressure compensated	page 11

PORTABLE FILTRATION UNITS

.....	page 28
-------	---------

DIRECTIONAL HYDRAULIC CONTROLS VALVES

Galtech monoblock valve	pages 1, 2
Galtech sectional valve	pages 2,3
Galtech proportional load sensing post compensated 50 GPM valve	page 3
Galtech valves, special application	page 4
Available options for Galtech valve	pages 5, 6
High pressure 2 way & 3 way ball valve	page 20
12 & 24 VDC 2/2, 3/2, 6/2, 8/3, selector valve	pages 13,14,15,17
Manual & pneumatic 3/2 selector valve	page 3
Rotary actuated selector valve	pages 20, 21
Shuttle valve	page 23
Log splitter valve	page 4
Stackable VDC solenoid valve, parallel & serie configuration	page 16
Various valve for D03 pattern	page 12

PRESSURE CONTROLS VALVES

Hi-low pressure control	page 12
Relief valve	pages 11, 24
Dual crossover relief valve	page 11, 24
Check valve	page 21
Single & double lock valve	page 22
Counterbalance valve	page 12
Hose burst valve	page 24
Sequence valve	page 22

FORMULAS & CONVERSIONS TABLES

.....	page 29
-------	---------

VERSO DE LA TABLE DES MATIÈRE
NE PAS IMPRIMER

MONOBLOCK VALVE 6 GPM

Q15



MODEL	DESCRIPTION	P & T PORTS	A & B PORTS	MAX. FLOW	MAX. PRESSURE
Q15/1E-F7SN-1X103/A1/M1-F3D-SAE	1 section D/A	SAE8	SAE6	6 GPM	4060 PSI
Q15/2E-F1SN-2X103RN/A1/M1-F3D-SAE*	2 sections D/A	SAE8	SAE6	6 GPM	4060 PSI
Q15/3E-F1SN-3X103RN/A1/M1-F3D-SAE*	3 sections D/A	SAE8	SAE6	6 GPM	4060 PSI
Q15/4E-F1SN-4X103RN/A1/M1-F3D-SAE*	4 sections D/A	SAE8	SAE6	6 GPM	4060 PSI

* Only available at the end of 2011.

MONOBLOCK VALVE 12 GPM

Q35



MODEL	DESCRIPTION	P & T PORTS	A & B PORTS	MAX. FLOW	MAX. PRESSURE
Q35-F7SN-103/A1/M1-S-SAE	1 section D/A	SAE8	SAE8	12 GPM	4350 PSI

MONOBLOCK VALVE 14 GPM

Q45



MODEL	DESCRIPTION	P & T PORTS	A & B PORTS	MAX. FLOW	MAX. PRESSURE
Q45/1E-F1SN-1X103/A1/M1-F3D-S-SAE	1 section D/A	SAE8-SAE10	SAE8	14 GPM	5000 PSI
Q45/2E-F1SN-2X103/A1/M1-F3D-S-SAE	2 sections D/A	SAE8-SAE10	SAE8	14 GPM	5000 PSI
Q45/3E-F1SN-3X103/A1/M1-F3D-S-SAE	3 sections D/A	SAE8-SAE10	SAE8	14 GPM	4500 PSI
Q45/4E-F1SN-4X103/A1/M1-F3D-S-SAE	4 sections D/A	SAE8-SAE10	SAE8	14 GPM	4300 PSI
Q45/5E-F1SN-5X103/A1/M1-F3D-S-SAE	5 sections D/A	SAE8-SAE10	SAE8	14 GPM	4300 PSI
Q45/6E-F1SN-6X103/A1/M1-F3D-S-SAE	6 sections D/A	SAE8-SAE10	SAE8	14 GPM	4300 PSI
Q45/7E-F1SN-7X103/A1/M1-F3D-S-SAE	7 sections D/A	SAE8-SAE10	SAE8	14 GPM	4000 PSI
Q45/8E-F1SN-8X103/A1/M1-F3D-S-SAE	8 sections D/A	SAE8-SAE10	SAE8	14 GPM	4000 PSI

MONOBLOCK VALVE 18 GPM

Q65



MODEL	DESCRIPTION	P & T PORTS	A & B PORTS	MAX. FLOW	MAX. PRESSURE
Q65-F7SN-103/A1/M1-F3D-SAE	1 section D/A	SAE10	SAE10	18 GPM	4350 PSI

MONOBLOCK VALVE 22 GPM

Q75



MODEL	DESCRIPTION	P & T PORTS	A & B PORTS	MAX. FLOW	MAX. PRESSURE
Q75/1E-F1SN-1X103/A1/M1-F3D-SAE	1 section D/A	SAE10-SAE12	SAE10	22 GPM	5000 PSI
Q75/2E-F1SN-2X103/A1/M1-F3D-SAE	2 sections D/A	SAE10-SAE12	SAE10	22 GPM	5000 PSI
Q75/3E-F1SN-3X103/A1/M1-F3D-SAE	3 sections D/A	SAE10-SAE12	SAE10	22 GPM	4300 PSI
Q75/4E-F1SN-4X103/A1/M1-F3D-SAE	4 sections D/A	SAE10-SAE12	SAE10	22 GPM	4000 PSI
Q75/5E-F1SN-5X103/A1/M1-F3D-SAE	5 sections D/A	SAE10-SAE12	SAE10	22 GPM	4000 PSI
Q75/6E-F1SN-6X103/A1/M1-F3D-SAE	6 sections D/A	SAE10-SAE12	SAE10	22 GPM	4000 PSI

Options • Rotary actuator dual - Axis joystick - Aluminum or stainless steel pneumatic actuator - Cable actuator - Hydraulic actuator - 12 or 24 VDC - Electro hydraulic actuator
Electro pneumatic actuator - 3 positions detent actuator - Dual axis - Over 100 different options in stock.

MONOBLOCK VALVE 32 GPM

Q95



MODEL	DESCRIPTION	P & T PORTS	A & B PORTS	MAX. FLOW	MAX. PRESSURE
Q95/1E-F1SN-1X103/A1/M1-F3D-SAE	1 section D/A	SAE12	SAE12	32 GPM	5000 PSI
Q95/2E-F1SN-2X103/A1/M1-F3D-SAE	2 sections D/A	SAE12	SAE12	32 GPM	5000 PSI
Q95/3E-F1SN-3X103/A1/M1-F3D-SAE	3 sections D/A	SAE12	SAE12	32 GPM	4350 PSI
Q95/5E-F1SN-5X103/A1/M1-F3D-SAE	5 sections D/A	SAE12	SAE12	32 GPM	3915 PSI
Q95/6E-F1SN-6X103/A1/M1-F3D-SAE	6 sections D/A	SAE12	SAE12	32 GPM	3915 PSI

SECTIONAL VALVE 13 GPM

Q30



MODEL	DESCRIPTION	P & T PORTS	A & B PORTS	MAX. FLOW	MAX. PRESSURE
Q30/1E-F7SN-1X103/A1/M1-F3D-S-SAE	1 section D/A	SAE8-SAE10	SAE6	13 GPM	5400 PSI
Q30/2E-F7SN-2X103/A1/M1-F3D-S-SAE	2 sections D/A	SAE8-SAE10	SAE6	13 GPM	5400 PSI
Q30/3E-F7SN-3X103/A1/M1-F3D-S-SAE	3 sections D/A	SAE8-SAE10	SAE6	13 GPM	5400 PSI
Q30/4E-F7SN-4X103/A1/M1-F3D-S-SAE	4 sections D/A	SAE8-SAE10	SAE6	13 GPM	5000 PSI
Q30/5E-F7SN-5X103/A1/M1-F3D-S-SAE	5 sections D/A	SAE8-SAE10	SAE6	13 GPM	5000 PSI
Q30/6E-F7SN-6X103/A1/M1-F3D-S-SAE	6 sections D/A	SAE8-SAE10	SAE6	13 GPM	5000 PSI
Q30/7E-F7SN-7X103/A1/M1-F3D-S-SAE	7 sections D/A	SAE8-SAE10	SAE6	13 GPM	4700 PSI
Q30/8E-F7SN-8X103/A1/M1-F3D-S-SAE	8 sections D/A	SAE8-SAE10	SAE6	13 GPM	4700 PSI
Q30/9E-F7SN-9X103/A1/M1-F3D-S-SAE	9 sections D/A	SAE8-SAE10	SAE6	13 GPM	4700 PSI
Q30/10E-F7SN-10X103/A1/M1-F3D-S-SAE	10 sections D/A	SAE8-SAE10	SAE6	13 GPM	4700 PSI

SECTIONAL VALVE 16 GPM

GSV50

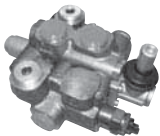

MODEL	DESCRIPTION	P & T PORTS	A & B PORTS	MAX. FLOW	MAX. PRESSURE
GSV50/1E-F7SN-1x103/A1/M1-F3D-S-SAE	1 section D/A	SAE8-SAE10	SAE8	16 GPM	5438 PSI
GSV50/2E-F7SN-2x103/A1/M1-F3D-S-SAE	2 sections D/A	SAE8-SAE10	SAE8	16 GPM	5438 PSI
GSV50/3E-F7SN-3x103/A1/M1-F3D-S-SAE	3 sections D/A	SAE8-SAE10	SAE8	16 GPM	5438 PSI
GSV50/4E-F7SN-4x103/A1/M1-F3D-S-SAE	4 sections D/A	SAE8-SAE10	SAE8	16 GPM	5075 PSI
GSV50/5E-F7SN-5x103/A1/M1-F3D-S-SAE	5 sections D/A	SAE8-SAE10	SAE8	16 GPM	5075 PSI
GSV50/6E-F7SN-6x103/A1/M1-F3D-S-SAE	6 sections D/A	SAE8-SAE10	SAE8	16 GPM	5075 PSI
GSV50/7E-F7SN-7x103/A1/M1-F3D-S-SAE	7 sections D/A	SAE8-SAE10	SAE8	16 GPM	4713 PSI
GSV50/8E-F7SN-8x103/A1/M1-F3D-S-SAE	8 sections D/A	SAE8-SAE10	SAE8	16 GPM	4713 PSI
GSV50/9E-F7SN-9x103/A1/M1-F3D-S-SAE	9 sections D/A	SAE8-SAE10	SAE8	16 GPM	4713 PSI
GSV50/10E-F7SN-10x103/A1/M1-F3D-S-SAE	10 sections D/A	SAE8-SAE10	SAE8	16 GPM	4713 PSI

SECTIONAL VALVE 22 GPM

Q80



MODEL	DESCRIPTION	P & T PORTS	A & B PORTS	MAX. FLOW	MAX. PRESSURE
Q80/1E-F7SN-1X103/A1/M1-F3D-SAE	1 section D/A	SAE12-SAE12	SAE10	22 GPM	5000 PSI
Q80/2E-F7SN-2X103/A1/M1-F3D-SAE	2 sections D/A	SAE12-SAE12	SAE10	22 GPM	5000 PSI
Q80/3E-F7SN-3X103/A1/M1-F3D-SAE	3 sections D/A	SAE12-SAE12	SAE10	22 GPM	5000 PSI
Q80/4E-F7SN-4X103/A1/M1-F3D-SAE	4 sections D/A	SAE12-SAE12	SAE10	22 GPM	4600 PSI
Q80/5E-F7SN-5X103/A1/M1-F3D-SAE	5 sections D/A	SAE12-SAE12	SAE10	22 GPM	4600 PSI
Q80/6E-F7SN-6X103/A1/M1-F3D-SAE	6 sections D/A	SAE12-SAE12	SAE10	22 GPM	4600 PSI
Q80/7E-F7SN-7X103/A1/M1-F3D-SAE	7 sections D/A	SAE12-SAE12	SAE10	22 GPM	4300 PSI
Q80/8E-F7SN-8X103/A1/M1-F3D-SAE	8 sections D/A	SAE12-SAE12	SAE10	22 GPM	4300 PSI
Q80/9E-F7SN-9X103/A1/M1-F3D-SAE	9 sections D/A	SAE12-SAE12	SAE10	22 GPM	4300 PSI
Q80/10E-F7SN-10X103/A1/M1-F3D-SAE	10 sections D/A	SAE12-SAE12	SAE10	22 GPM	4300 PSI

Options • Rotary actuator dual - Axis joystick - Aluminum or stainless steel pneumatic actuator - Cable actuator - Hydraulic actuator - 12 or 24 VDC - Electro hydraulic actuator
Electro pneumatic actuator - 3 positions detent actuator - Dual axis - Over 100 different options in stock.

SECTIONAL VALVE 40 GPM Q130

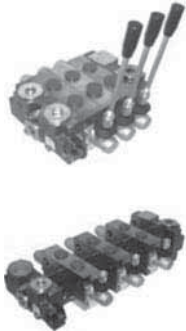

MODEL	DESCRIPTION	P & T PORTS	A & B PORTS	MAX. FLOW	MAX. PRESSURE
Q130/1E- F7SN-1X103/A1/M1-F3D-SAE	1 section D/A	SAE 16 or 20	SAE12 or 16	40 GPM	5438 PSI
Q130/2E- F7SN-2X103/A1/M1-F3D-SAE	2 sections D/A	SAE 16 or 20	SAE12 or 16	40 GPM	5438 PSI
Q130/3E- F7SN-3X103/A1/M1-F3D-SAE	3 sections D/A	SAE 16 or 20	SAE12 or 16	40 GPM	5438 PSI
Q130/4E- F7SN-4X103/A1/M1-F3D-SAE	4 sections D/A	SAE 16 or 20	SAE12 or 16	40 GPM	5075 PSI
Q130/5E- F7SN-5X103/A1/M1-F3D-SAE	5 sections D/A	SAE 16 or 20	SAE12 or 16	40 GPM	5075 PSI
Q130/6E- F7SN-6X103/A1/M1-F3D-SAE	6 sections D/A	SAE 16 or 20	SAE12 or 16	40 GPM	5075 PSI
Q130/7E- F7SN-7X103/A1/M1-F3D-SAE	7 sections D/A	SAE 16 or 20	SAE12 or 16	40 GPM	4713 PSI
Q130/8E- F7SN-8X103/A1/M1-F3D-SAE	8 sections D/A	SAE 16 or 20	SAE12 or 16	40 GPM	4713 PSI
Q130/9E- F7SN-9X103/A1/M1-F3D-SAE	9 sections D/A	SAE 16 or 20	SAE12 or 16	40 GPM	4713 PSI
Q130/10E- F7SN-10X103/A1/M1-F3D-SAE	10 sections D/A	SAE 16 or 20	SAE12 or 16	40 GPM	4713 PSI

PROPORTIONAL VALVE (LOAD SENSING) POST COMPENSATED 50 GPM GSL200

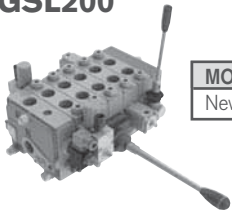

MODEL	DESCRIPTION	P & T PORTS	A & B PORTS	MAX. FLOW	MAX. PRESSURE
New product, call for code.		SAE16	SAE16	50 GPM	5000 PSI

3 WAY 2 POSITIONS SELECTOR «IF»

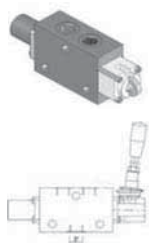

MODEL	DESCRIPTION	P & T PORTS	MAX. FLOW	MAX. PRESSURE
IF 9/16"-1-A1-M4(2-1)	3/2 selector spring return	SAE6	9.25 GPM	4350 PSI
IF 9/16"-1-A1-R6	3/2 selector detent	SAE6	9.25 GPM	4350 PSI
IF 7/8"-1-A1-M4(2-1)	3/2 selector spring return	SAE10	18.5 GPM	4350 PSI
IF 7/8"-1-A1-R6	3/2 selector detent	SAE10	18.5 GPM	4350 PSI
IF 1 1/16"-1-A1-M4(2-1)	3/2 selector spring return	SAE12	32 GPM	4350 PSI
IF 1 1/16"-1-A1-R6	3/2 selector detent	SAE12	32 GPM	4350 PSI
IF 1 1/16"-1-A1-PINP(2-1)	3/2 selector pneumatic actuator, spring return	SAE12	32 GPM	4350 PSI

HYDRAULIC, PNEUMATIC SELECTOR



MODEL	DESCRIPTION	P & T PORTS	MAX. FLOW	MAX. PRESSURE	MAX. SHIFT PRESSURE
BEZ901211	3/2 selector valve c/w pneumatic actuator, spring return	SAE16	66 GPM	5075 PSI	3625 PSI

LOG LOADER VALVE

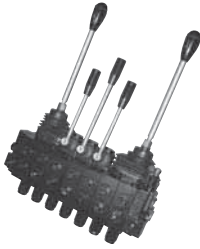

MODEL	DESCRIPTION	P & T PORTS	A & B PORTS	MAX. FLOW	MAX. PRESSURE
045070103007280	7 sections, 2 dual axis joysticks on 2, 3, 5 & 6	SAE8-SAE10	SAE6	14 GPM	4000 PSI
045080103065900	8 sections, 2 dual axis joysticks on 2, 3, 6 & 7	SAE8-SAE10	SAE8	14 GPM	4000 PSI

Other models and configurations available.

LOG SPLITTER VALVE



MODEL	DESCRIPTION	P & T PORTS	A & B PORTS	MAX. FLOW	MAX. PRESSURE
C908	Kick out 750 @ 2000 PSI	3/4"	1/2"	0/20 GPM	2500 PSI

DUMP VALVE



MODEL	DESCRIPTION	P & T PORTS	A & B PORTS	MAX. FLOW	MAX. PRESSURE
045010101024200	Single acting, 12 VDC, CVHA	SAE8-SAE10	SAE8	14 GPM	5000 PSI
055010101046200	Single acting, 12 VDC, CVHA	SAE10-SAE12	SAE10	22 GPM	5000 PSI
095010101012200	Single acting, pneumatic actuator	SAE12-SAE12	SAE12	32 GPM	5000 PSI
100010101007290	Single acting, pneumatic actuator	SAE16-SAE16	SAE16	40 GPM	5438 PSI

Other models and configurations available.

HYDRAULIC AUTOCYCLE VALVE



MODEL	DESCRIPTION	P & T PORTS	A & B PORTS	MAX. FLOW	MAX. PRESSURE
080020203009200	Auto cycle for D.A. cylinder	SAE12-SAE12	SAE12	22 GPM	5000 PSI
100020203008200	Auto cycle for D.A. cylinder	SAE16-SAE16	SAE16	40 GPM	5438 PSI

Other models and configurations available.



OPTIONS AVAILABLE FOR GALTECH VALVES

Number	Description	Part # per valve model						
		Q15	Q35	Q45-Q30-GSV50	Q65	Q75-Q80-Q95	Q130	GS200
LEVER SIDE								
A1-A2	Lever assy with plastic cap	N/A	03600 A1-A2	03600 A1-A2	N/A	N/A	N/A	N/A
A1-A2	Lever assy with aluminum cap	TBA	03610 A1/A2-10	03610 A1/A2-10	08600 A1-A2	08600 A1-A2	10610 A1/A2	TBA
A1-A2/06	Lever assy with spool travel limiter	TBA	03606 A1/A2-06	03606 A1/A2-06	08606 A1/A2-06	08606 A1/A2-06	10606 A1/A2-06	TBA
A3	Plastic cap for NO HANDLE option	N/A	03614 A3	03614 A3	N/A	N/A	N/A	N/A
A3	Aluminum cap for NO HANDLE option	TBA	03614 A3/03	03614 A3/03	08614 A3	08614 A3	10614 A3	TBA
A3-SS	Stainless steel cap for NO HANDLE option	N/A	N/A	N/A	08614 A3-SS	08614 A3-SS	10614 A3-SS	N/A
A4	Threaded type actuator	N/A	03617 A4/03	03617 A4/03	08617 A4	08617 A4	10617 A4	N/A
A5	Push/Pull spool actuator	N/A	03619 A5/03	03619 A5/03	08619 A5	08619 A5	10619 A5	N/A
A6	Direct acting spool eye	TBA	03620 A6	03620 A6	08620 A6	08620 A6	10620 A6	TBA
A8	Cable shift adaptor	TBA	03622 A8/03	03622 A8/03	08622 A8	08622 A8	10622 A8	TBA
C1	Cable	TBA	1 size cable fits all valves, available in various lengths					
SL	Cable shift lever assy	TBA	03630 SL/03	03630 SL/03	08630 SL	08630 SL	08630 SL	TBA
SLSD	Swivel cable shift (not to be used with float)	N/A	08630 SLSD	08630 SLSD	08630 SLSD	08630 SLSD	08630 SLSD	TBA
SLA15	Cable shift dual axis joystick	TBA	N/A	03631 SLA15/DU	N/A	03631 SLA15/DU	03631 SLA15/DU	TBA
A15	Direct mount dual axis joystick	TBA	N/A	03637 A15-R 05637 A15R (GSV50)	N/A	08637 A15-D or S	10637 A15-D or S	TBA
A25	Direct mount dual axis joystick HEAVY DUTY	N/A	N/A	03638 A25 R N/A GSV50	N/A	08625 A25-D or S	N/A	N/A
A35	Direct mount dual axis joystick, left or right HEAVY DUTY	N/A	N/A	N/A	N/A	08637 A35-D or S	N/A	N/A
A16	Direct mount, simultaneous spool actions	N/A	N/A	03639 A16 N/A GSV50	N/A	N/A	N/A	N/A

POSITIONNER SIDE

M1	3 positions spring return to neutral	TBA	03730 M1/03	03730 M1/03	08730 M1	08730 M1	10730 M1	TBA
M2	2 positions spring to neutral 0-1	N/A	03732 M2/03	03732 M2/03	08732 M2	08732 M2	10732 M2	N/A
M3	2 positions spring to neutral 0-2	N/A	03733 M3/03	03733 M3/03	08733 M3	08733 M3	10733 M3	N/A
M4 (2-1)	2 positions 1 & 2 spring return	N/A	03735 M4 2-1/03	03735 M4 2-1/03	08735 M4 2-1	08735 M4 2-1	10735 M4 2-1	N/A
MSW	Micro switch assy	TBA	03614 MSW	03614 MSW	08614 MSW	08614 MSW	10614 MSW	N/A
R1	Detent position on 1, spring return to neutral on 2	TBA	03741 R1/03	03741 R1/03	08741 R1	08741 R1	10741 R1	TBA
R2	Detent positioner on 2, spring return to neutral on 1	TBA	03742 R2/02	03742 R2/03	08742 R2	08742 R2	10742 R2	TBA
R3	3 positions detent kit	TBA	03743 R3/03	03743 R3/03	08743 R3	08743 R3	10743 R3	TBA
R4	2 positions detent on 0 and 1 only position # 2 blocked	TBA	03744 R4/03	03744 R4/03	08744 R4	08744 R4	10744 R4	TBA
R5	2 positions detent on 0 to 2 only position # 1 blocked	TBA	03745 R5/03	03745 R5/03	08745 R5	08745 R5	10745 R5	TBA
R6	2 positions detent on 1 and 2 only no neutral position	TBA	03746 R6/03	03746 R6/03	08746 R6	08746 R6	10746 R6	TBA
R7	4th position float pull (combine with 116 & Z1)	N/A	N/A	03747 R7/03	N/A	08747 R7	N/A	N/A
R8	4th position float, detent 1 & 2 positions spring return (116 & Z1)	N/A	N/A	03748 R8/03	N/A	08748 R8	10748 R8	N/A
Z1	Float adaptor (pull)	N/A	N/A	03651 Z1	N/A	08651 Z1	10751 Z1	N/A
R10/Z1	4th position float detent positioner	N/A	03750 R10-Z1/03	03750 R10-Z1/03	N/A	08750 R10-Z1	N/A	N/A
R1K	Hydraulic detent positioner adjustable (kick out) on position spring return to neutral on position 2	N/A	N/A	03741 R1K/03	N/A	08741 R1K	10741 R1K	N/A
R2K	Hydraulic detent positioner (adjustable kick out) on position 2 spring return to neutral on position 1	N/A	N/A	03742 R2K/03	N/A	08742 R2K	10742 R2K	N/A
R3K	3 positions hydraulic kick out detent kit	N/A	N/A	03743 R3K/03	N/A	08743 R3K	10743 R3K	N/A
M1-U1	Rear mounting direct acting threaded rod, 3 positions spring return to neutral	N/A	03701 M1-U1/03	03701 M1-U1/03	08701 M1-U1	08701 M1-U1	10701 M1-U1	N/A
M1-U2	Rear mounting cable adaptor 3 positions spring return to neutral	N/A	03715 M1-U2/03	03715 M1-U2/03	08715 M1-U2	08715 M1-U2	10715 M1-U2	N/A

COMPLETE ACTUATORS

P1-N	Direct acting, 3 positions, pneumatic actuator	N/A	03661 P1-N.S	03661 P1-N.S	08661 P1-N.S	08661 P1-N.S	10661 P1-N.S	N/A
P1-NP	Progressive shift & 3 positions, pneumatic actuator	N/A	03661 P1-NP.S	03661 P1-NP.S	08661 P1-NP.S	08661 P1-NP.S	10661 P1-NP.S	N/A
P1-NP-SS	Progressive shift & 3 positions, stainless steel pneumatic actuator	N/A	N/A	N/A	08661 P1-NP-SS	08661 P1-NP-SS	10661 P1-NP-SS	N/A
P4P	4th position float pneumatic actuator	N/A	N/A	N/A	N/A	08661 P4P	N/A	N/A



OPTIONS AVAILABLE FOR GALTECH VALVES

Number	Description	Part # per valve model						
		Q15	Q35	Q45-Q30-GSV50	Q65	Q75-Q80-Q95	Q130	GSL200
COMPLETE ACTUATORS (SUIT)								
D2-12VDC	Electro-hydraulic actuator 12 VDC (use with E62)	N/A	N/A	N/A	N/A	08681 D2-12 R1/R2	10681 D2-12 R1/R2	N/A
D2-24VDC	Electro-hydraulic actuator 24 VDC (use with E62)	N/A	N/A	N/A	N/A	08682 D2-24 R1/R2	10682 D2-24 R1/R2	N/A
D3-12VDC	12 VDC pneumatic actuator, 3 positions	N/A	03691 D3-F-12DC	03691 D3-F-12DC	08691 D3-V-12DC	08691 D3-V-12DC	10691 D3-U-12DC	N/A
D3-24VDC	24 VDC pneumatic actuator, 3 positions	N/A	03692 D3-F-24DC	03692 D3-F-24DC	08692 D3-V-24DC	08692 D3-V-24DC	10692 D3-U-24DC	N/A
RTL	Rotary actuator	N/A	03799 RTL	03799 RTL	08799 RTL	08799 RTL	10799 RTL	N/A
RTLD-SS	Rotary actuator, stainless steel	N/A	03799 RTL-SS	03799 RTL-SS	08799 RTL-SS	08799 RTL-SS	10799 RTL-SS	N/A
C3	Cam control, 2 positions spring return to position #2 (N/O, return to tank when activated)	N/A	03792 C2-C3	03792 C2-C3	08792 C2-C3	08792 C2-C3	10792 C2-C3	N/A
H1	High pressure hydraulic actuator, 3 positions	N/A	03779 H1	03779 H1	08779 H1	08779 H1	10779 H1	N/A
H5	Low pressure hydraulic actuator, 3 positions (Ideal for hydraulic joystick installation)	N/A	03785 H5	03785 H5	08785 H5	08785 H5	10785 H5	N/A
D41-12VDC	ON/OFF 12 VDC CVHA*	TBA	N/A	02571 103/71	N/A	05571 103/71	N/A	N/A
D41-24VDC	ON/OFF 24 VDC CVHA*	TBA	N/A	02571 103/72	N/A	05571 103/72	N/A	N/A
D9-12VDC	ON/OFF 12 VDC less handle*	N/A	N/A	02571 103/91	N/A	N/A	N/A	N/A
D9-24VDC	ON/OFF 24 VDC less handle*	N/A	N/A	02571 103/92	N/A	N/A	N/A	N/A

*Various spools available for above options. Spool included in kit.

AUXILIARY BLOCS & VALVES

V01	Single "pilot check" manifold mounted to directional valve	N/A	N/A	03835 V01 SAE	N/A	08835 V01 SAE	-	N/A
V03	Double "pilot check" manifold mounted to directional valve	N/A	N/A	03837 V03 SAE	N/A	08837 V03 SAE	-	N/A
VFE	12 VDC float positioner direct mounted	N/A	N/A	03842 VFE/12 N/A GSV50	N/A	N/A	N/A	N/A
V04	Anti-cavitation valve manifold mounted to directional valve	N/A	N/A	03808 V04	N/A	08808 V04	10808 V04	N/A
V30	Safety valve manifold mounted to directional valve	N/A	N/A	03800 V30	N/A	08800 V30	10880 V30	N/A
V33	Safety + anti-cavitation valve manifold mounted to directional valve	N/A	N/A	03803 V33	N/A	08803 V33	10803 V33	N/A

INTERMEDIATE SECTIONS

E68	Mid section with flow control	N/A	N/A	03885-E68-61S	N/A	08885 E68	10885 E68	N/A
E50	Mid section with relief valve	N/A	N/A	03850 E50	N/A	08850 E50	10850 E50	N/A
E51	Mid outlet section	N/A	N/A	03853 E51-SAE	N/A	08853 E51	10853 E51	N/A
E53	Mid inlet section	N/A	N/A	03854 E53-SAE	N/A	08854 E53	10854 E53	N/A
E62	Mid section with unloading valve	N/A	N/A	N/A	N/A	08880 E62-01R	10880 E62-01R	N/A
E61	Blank spacer section	N/A	N/A	03885 E61	N/A	08877 E61	10877 E61	N/A



GEAR PUMP GROUP 1 SP

SAE AA standard front flange 2" diameter pilot, 2 bolts, 1/2" diameter keyed shaft.
We also stock metric style mountings and multiple pump hardware.



MODEL	0.9	1.2	1.6	2.0	2.5	3.2	3.7	4.2	5.0	6.3	7.8	9.8
Displacement	.055	.072	.10	.12	.15	.20	.23	.26	.31	.38	.47	.60
Flow in GPM at 1800 RPM	.43	.56	.78	.94	1.17	1.56	1.79	2.05	2.42	2.96	3.66	4.68
Max. operating pressure	3480	3480	3480	3190	3190	3045	3045	2755	2610	2465	2465	2175
Maximum RPM	6000	6000	6000	5500	5000	4500	4000	3500	3000	2700	2500	2000
Inlet size	SAE6	SAE6	SAE6	SAE6	SAE8	SAE8	SAE8	SAE8	SAE8	SAE8	SAE8	SAE8
Outlet size	SAE6	SAE6	SAE6	SAE6	SAE8	SAE8	SAE8	SAE8	SAE8	SAE8	SAE8	SAE8



GEAR PUMP AND MOTOR GROUP 2 SP

SAE A standard front flange 3 1/4" diameter pilot, 2 bolts, 5/8" keyed shaft.
We also stock metric style mountings and multiple pumps hardware.



MODEL	4	6	8.5	11	14	16	19	22	26
Displacement	.24	.37	.52	.67	.85	1.01	1.19	1.37	1.59
Flow in GPM at 1800 RPM	1.9	2.85	3.89	5.3	6.55	7.56	8.96	10.68	12.31
Max. operating pressure	3625*	3625*	3625*	3625*	3625*	3325	3045	2755	2465
Maximum RPM	4000	4000	3500	3500	3500	3500	3300	2800	2500
Inlet size	SAE10	SAE10	SAE10	SAE12	SAE12	SAE12	SAE12	SAE12	SAE12
Outlet size	SAE10	SAE10	SAE10	SAE10	SAE10	SAE10	SAE10	SAE10	SAE10

* Higher pressure available with cast iron covers (on request).

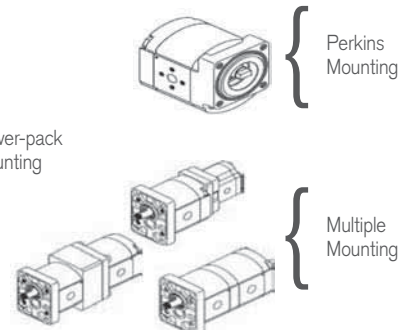
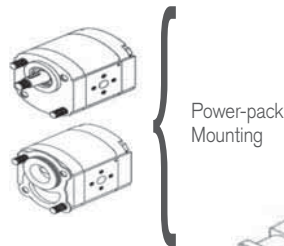
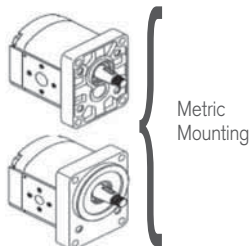
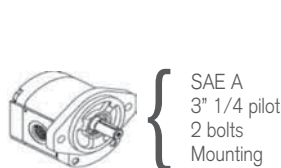

GEAR PUMP AND MOTOR GROUP 3 SP

SAE B" standard front flange, 4" diameter pilot, 2 bolts, 7/8" diameter keyed shaft.
 We also stock metric style mountings and multiple pumps hardware.



MODEL	19	22	29	33	36	44	52	62
Displacement	1.16	1.36	1.79	2	2.22	2.65	3.15	3.73
Flow in GPM at 1800 RPM	9.4	10.6	13.95	15.58	17.30	20.65	24.55	29.06
Maximum operating pressure	3600	3600	3600	3600	3600	3500	3000	2900
Maximum RPM	3500	3500	3300	3300	3300	3000	3000	2500
Inlet size	SAE16	SAE16	SAE16	SAE16	SAE16	SAE16	SAE16	SAE16
Outlet size	SAE12	SAE12	SAE12	SAE12	SAE12	SAE12	SAE12	SAE12

* Higher pressure available with cast iron covers (on request).

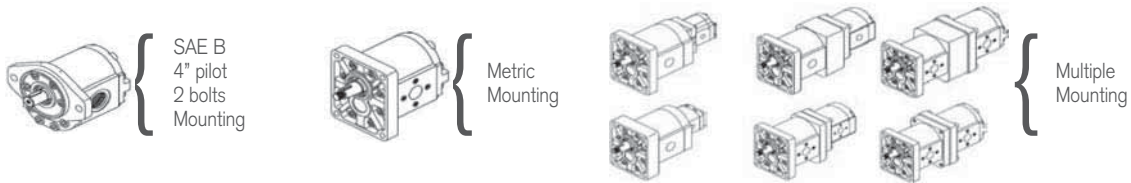

PUMP CODE

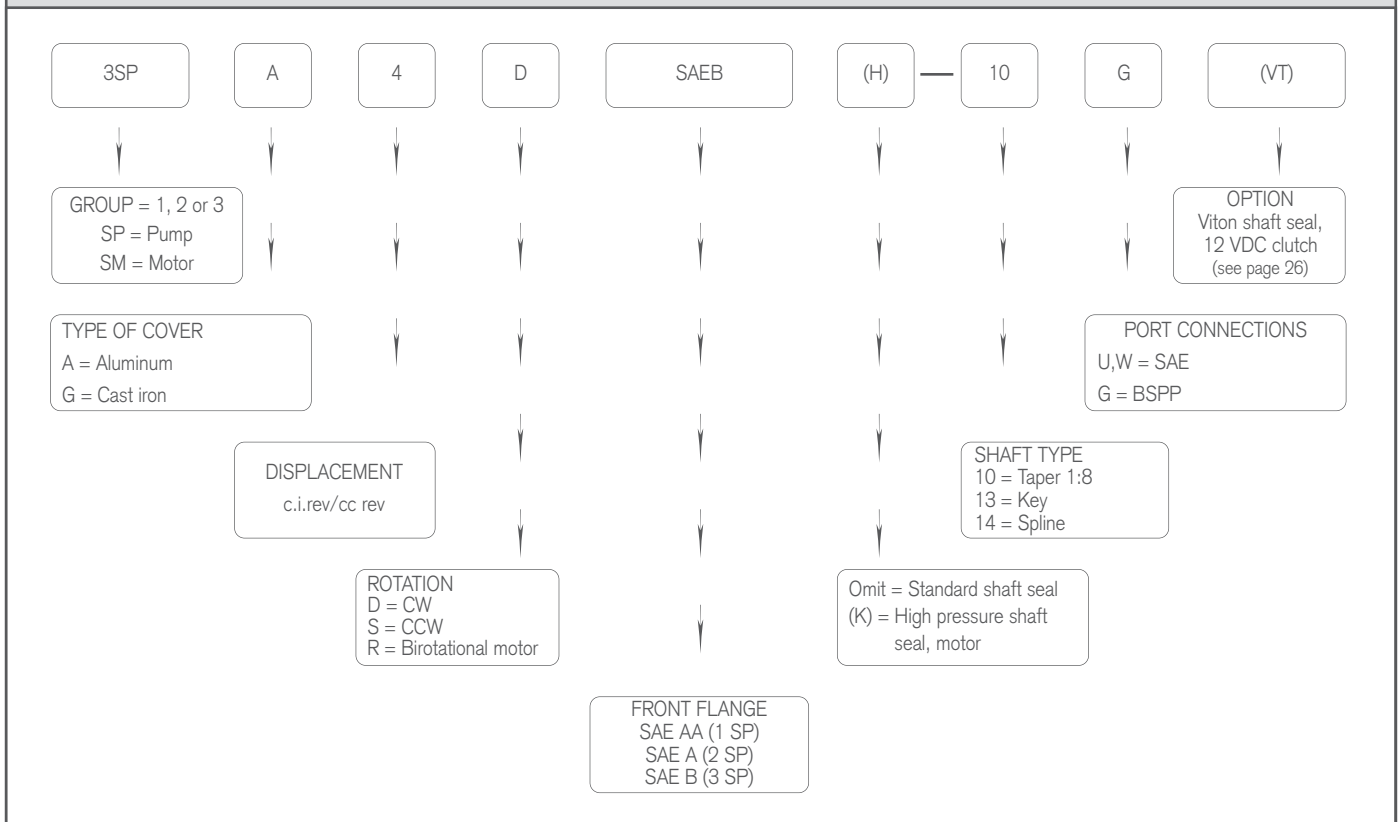

GEAR PUMP GROUP S12

SAE A, Pilot, 2 bolts, 3/4" diameter key or 11 splines shaft.

MODEL	2	4	5	8	11	13	16	19	23	25	27	31	33
Displacement	0.15	0.24	0.31	0.5	0.68	0.81	0.99	1.2	1.43	1.55	1.65	1.89	2.01
Flow in gpm @ 1800 RPM	1.16	1.9	2.42	3.89	5.3	6.31	7.71	9.35	11.14	12.08	12.86	14.73	15.66
Max. operating press	3915	3915	3915	3915	3915	3915	3915	3915	3335	2900	2900	2900	2680
Maximum RPM	4000	4000	4000	4000	3600	3300	3000	3000	2800	2400	2400	2300	2200
Inlet size	SAE12	SAE12	SAE12	SAE12	SAE12	SAE12	SAE12	SAE12	SAE12	SAE12	SAE12	SAE16	SAE16
Outlet size	SAE10	SAE10	SAE10	SAE10	SAE10	SAE10	SAE10	SAE10	SAE10	SAE10	SAE10	SAE12	SAE12

Multiple pumps available starting March 2011.

Birotational motors with/without drain available.

Pump coding :

Sample : S12 A 1 74 S 0 TS FE3 005 09

S12 = Serie

A = Single pump, B = Multiple pumps

1 = CW rotation, 2 = CCW rotation

74 = SAE A 2 bolts front flange

S = No outboard bearing

TS = Standard rear cover

FE3 = SAE ports

005 = Displacement (cc/rev)

09 = 3/4" - 11 splines, 33 = 3/4" key

Webster

AVAILABLE ON REQUEST ONLY

YC

	058	077	116	125	155	194
PSI	2500	2000	2000	2000	2000	2000
RPM	3000	3000	3000	3000	3000	3000
PORTS	SAE/NPT	SAE/NPT	SAE/NPT	SAE/NPT	SAE/NPT	SAE/NPT

Optional rear cover with flow divider • OEM versions available • motor version

SAE 2 bolts front flange • 3/4" key shaft • 3/4" - 11 splines shaft • 5/8" - 9 splines.

KB

	065	086	108	129	151	194	237	280	323	388
PSI	2500	2500	2500	2500	2500	2500	2500	2500	2500	2500
RPM	3000	3000	3000	3000	3000	3000	3000	3000	3000	2000
PORTS	SAE	SAE	SAE	SAE	SAE	SAE	SAE	SAE	SAE	SAE

Optional rear cover with flow divider • OEM versions available • motor version

SAE B front flange • 7/8" key shaft • 7/8" - 13 splines shaft • 1" key shaft.

YC



KB

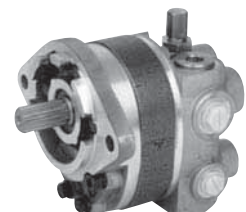

HAND PUMP

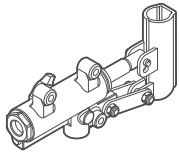

DOUBLE ACTING MANUAL PUMP LESS RESERVOIR

MODEL	DISPLACEMENT		MAX. PRESSURE		FORCE		WEIGHT	
	cm ³ /cycle	in ³ /cycle	bar	PSI	daN	lbs	Kg	lbs
FLN 20	20	1.22	350	4060	60	135	2.6	5.73

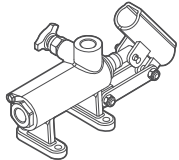

DOUBLE ACTING MANUAL PUMP LESS RESERVOIR

MODEL	DISPLACEMENT		MAX. PRESSURE		FORCE		WEIGHT	
	cm ³ /cycle	in ³ /cycle	bar	PSI	daN	lbs	Kg	lbs
FPN 50	44	2.68	280	4060	91.8	206	3.4	7.5

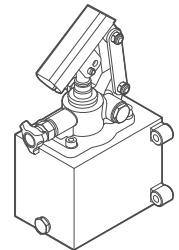

DOUBLE ACTING MANUAL PUMP WITH RESERVOIR

MODEL	DISPLACEMENT		MAX. PRESSURE		FORCE		WEIGHT	
	cm ³ /cycle	in ³ /cycle	bar	PSI	daN	lbs	Kg	lbs
CSN 12	12	0.73	380	5510	46	103	3.0	6.62
CSN 25	25	1.53	350	5075	77	173	3.0	6.62
CSN 45	45	2.75	280	4060	93	209	3.0	6.62

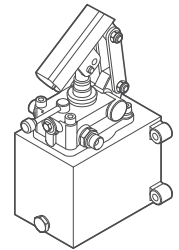

DOUBLE ACTING MANUAL PUMP WITH 4/3 MANUAL VALVE & RESERVOIR

MODEL	DISPLACEMENT		MAX. PRESSURE		FORCE		WEIGHT	
	cm ³ /cycle	in ³ /cycle	bar	PSI	daN	lbs	Kg	lbs
CSIN 12	12	0.73	380	5510	46	103	3.5	7.72
CSIN 25	25	1.53	350	5075	77	173	3.5	7.72
CSIN 45	45	2.75	280	4060	93	209	3.5	7.72

AVAILABLE RESERVOIRS FOR CSN & CSIN PUMPS

MODEL	VOLUME		WIDTH	DIMENSIONS (INCHES)			WEIGHT lbs
	LITRE	GALLON		DEPTH	HEIGHT		
935216001000000	1	0.26	3.937	5.906	4.724	4.85	
935216002000000	2	0.53	3.937	5.906	7.283	6.62	
935216003000000	3	0.79	3.937	5.906	10.039	8.16	
935216005000000	5	1.32	6.89	6.89	7.874	11.69	
935216007000000	7	1.85	6.89	6.89	10.827	14.55	
935216010000000	10	2.64	6.89	6.89	14.961	18.30	

LEVER FOR FLN20,FPN50,CSN & CSIN

MODEL	LENGTH (CM)	LENGTH (INCHES)
935299034000000	60	23.62

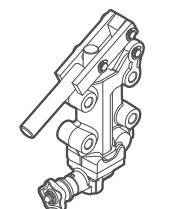

SINGLE ACTING PUMP LESS RESERVOIR

MODEL	DISPLACEMENT		MAX. PRESSURE		FORCE		WEIGHT	
	cm ³ /cycle	in ³ /cycle	bar	PSI	daN	lbs	Kg	lbs
IS6	20	1.22	250	3625	20	112	5.6	12.35
IS7	30	1.83	200	2900	65	146	5.6	12.35

ADJUSTABLE FLOW CONTROL VALVE, PRESSURE COMPENSATED

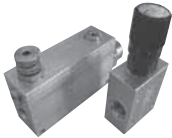

MODEL	DESCRIPTION	INLET PORT (P) CONTROL PORT (C) EXCESS PORT (B)	MAX. FLOW AT INLET	MAX. CONTROLLED FLOW	MAX. PRESSURE
RFPA08SA	Adjustable flow control, pressure compensated	SAE8	16 GPM	9 GPM	3915 PSI
RFPA10SA	Adjustable flow control, pressure compensated	SAE10	26 GPM	17 GPM	3915 PSI
RFPA12SA	Adjustable flow control, pressure compensated	SAE12	40 GPM	24 GPM	3915 PSI
RFPA16SA	Adjustable flow control, pressure compensated	SAE16	100 GPM	50 GPM	3915 PSI
RFP9010SB	Adjustable flow control, pressure compensated	SAE10	24 GPM	13 GPM	4350 PSI
RFP9012SB	Adjustable flow control, pressure compensated	SAE12	24 GPM	13 GPM	4350 PSI
RFAVLP1010SA	Adjustable flow control, pressure compensated with relief valve	SAE10	26 GPM	17 GPM	3915 PSI
RFAVLP1012SA	Adjustable flow control, pressure compensated with relief valve	SAE12	40 GPM	24 GPM	3915 PSI
RFPAEV-AVLP16S	Adjustable flow control, pressure compensated with relief & diverter valves	SAE16 (T=SAE10)	100 GPM	50 GPM	3915 PSI

Other models or configurations available upon request.

ADJUSTABLE RELIEF VALVE



MODEL	DESCRIPTION	PORTS	MAX. GPM	PRESSURE AJUST. RANGE	ADJUSTMENT TYPE	MAX. PRESSURE
VLP40-06S02A	Adjustable direct acting relief valve	SAE6	6.6 GPM	580-3625 PSI	Hex	5075 PSI
VLP40-08S02A	Adjustable direct acting relief valve	SAE8	9.25 GPM	580-3625 PSI	Hex	5075 PSI
VLP40-08S00D	Adjustable direct acting relief valve	SAE8	9.25 GPM	73-580 PSI	With cap	5075 PSI
VLP80-10S02A	Adjustable direct acting relief valve	SAE10	21 GPM	580-3625 PSI	Hex	4350 PSI
VLP80-12S02A	Adjustable direct acting relief valve	SAE12	21 GPM	580-3625 PSI	Hex	4350 PSI
VLP80-12S00D	Adjustable direct acting relief valve	SAE12	21 GPM	73-580 PSI	With cap	4350 PSI
VLP130-12S02A	Adjustable direct acting relief valve	SAE12	34.5 GPM	580-3625 PSI	Hex	4350 PSI
VLP130-16S02A	Adjustable direct acting relief valve	SAE16	34.5 GPM	580-3625 PSI	Hex	4350 PSI
VLP130-16S00D	Adjustable direct acting relief valve	SAE16	34.5 GPM	73-580 PSI	With cap	4350 PSI
VLP200PL16S02A	Adjustable relief valve, pilot operated	SAE16	53 GPM	580-3625 PSI	Hex	3625 PSI

Other models or configurations available upon request.

DUAL CROSSOVER RELIEF VALVE

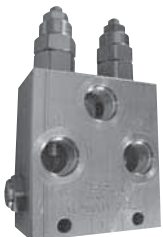

MODEL	DESCRIPTION	PORTS	MAX. GPM	PRESSURE AJUST. RANGE	ADJUSTMENT TYPE	MAX. PRESSURE
VLP40-DIL08S02A	Dual pressure relief valve	SAE8	10.5 GPM	580-3625 PSI	Hex	4350 PSI
VLP80-DIL10S02A	Dual pressure relief valve	SAE10	21 GPM	580-3625 PSI	Hex	4350 PSI
VLP130-DIL12S02A	Dual pressure relief valve	SAE12	34.5 GPM	73-580 PSI	Hex	3625 PSI
VLP40-DA08S02A	Dual pressure relief valve with anticavitation	SAE8	10.5 GPM	580-3625 PSI	Hex	4350 PSI
VLP80-DA10S02A	Dual pressure relief valve with anticavitation	SAE10	21 GPM	580-3625 PSI	Hex	4350 PSI

Other models or configurations available upon request.

COUNTERBALANCE VALVE

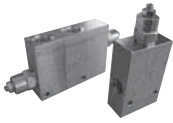

MODEL	DESCRIPTION	PILOT PORTS	MAX. GPM	PRESSURE ADJUST. RANGE	PILOT RATIO	ADJUSTMENT TYPE	MAX. PRESSURE
OVCSE-08S1	Single counterbalance valve	SAE8 (SAE4)	16 GPM	290-2900 PSI	4.25 :1	Hex	5075 PSI
OVCSE-12S01	Single counterbalance valve	SAE12 (SAE4)	26 GPM	290-2900 PSI	4.25 :1	Hex	5075 PSI
OVCDE08S02	Double counterbalance valve	SAE8	10 GPM	725-5075 PSI	4.25 :1	Hex	5075 PSI
OVCDE10S02	Double counterbalance valve	SAE10	16 GPM	725-5075 PSI	4.25 :1	Hex	5075 PSI

Other models or configurations available upon request.

FLOW DIVIDER/COMBINER VALVE



MODEL	DESCRIPTION	PORTS	MIN GPM	MAX. GPM	MAX. PRESSURE	MATERIAL
DFR12S06	50/50 Divider/combiner	SAE12	16 GPM	25 GPM	3625 PSI	Aluminum
DFR16S07	50/50 Divider/combiner	SAE16	24 GPM	40 GPM	3625 PSI	Aluminum

Other models or configurations available upon request, see page 15 (Poclair).

2 STAGE HI-LOW PRESSURE VALVE



MODEL	DESCRIPTION	PORTS	MAX. GPM (LOW PRESSURE)	MAX. GPM (HIGH PRESSURE)	PRESSURE RANGE HIGH FLOW	PRESSURE RANGE LOW FLOW	ADJUSTMENT TYPE	MAX. PRESSURE
VEPVLP4003AS	Hi-low pressure relief & unloading valve	SAE	10 GPM	10 GPM	290-1450 PSI	870-5075 PSI	Hex	5075 PSI
VEPVLP8003AS	Hi-low pressure relief & unloading valve	SAE	21 GPM	21 GPM	290-1450 PSI	870-5075 PSI	Hex	5075 PSI
VEPVLP15003AS	Hi-low pressure relief & unloading valve	SAE	35 GPM	10 GPM	290-1450 PSI	870-5075 PSI	Hex	4060 PSI

Other models or configurations available upon request.

SUBPLATE MOUNTED VALVES

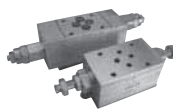

MODEL	DESCRIPTION	MAX. GPM	PRESSURE ADJUST. RANGE	ADJUSTMENT TYPE	PILOT RATIO	MAX. PRESSURE
STDVUFC3A	Flow control with checks CETOP 3	10.5 GPM	-	Hex	-	4350 PSI
VLP40DIFC302A	Dual pressure relief valve CETOP 3	10 GPM	580-3625 PSI	Hex	-	Aluminum
VBDFC3	Double pilot operated check CETOP 3	9.26 GPM	-	-	4:1	Aluminum
VADFC3	Auto cycle 4/2 valve CETOP 3	8 GPM	580-3625 PSI	Hex	-	Aluminum

Other models or configurations available upon request.

Also available from CBF : complete line of ca 4/2 solenoid valves, etc...rtridge valves, 2/2, 3/2



KV-2/2-6
ELECTRIC SELECTOR VALVE 2 WAYS, 2 POSITIONS

8 GPM, 3000 PSI
12 and 24 VDC, 110 VAC, 8 GPM

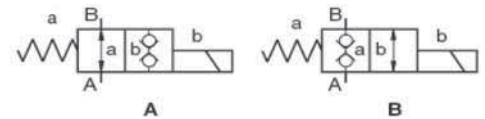
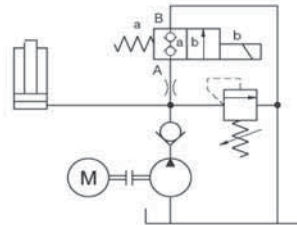
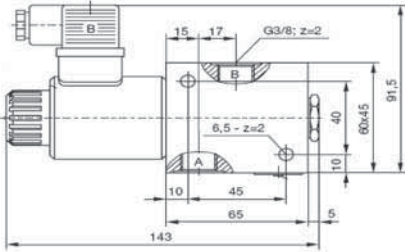

MODEL	MAX. GPM	MAX. PRESSURE	PORTS	VOLTAGE	TYPE
KV-2/2-6-S-A-12V	8 GPM	3000 PSI	SAE8	12 VDC	Open
KV-2/2-6-S-A-24V	8 GPM	3000 PSI	SAE8	24 VDC	Open
KV-2/2-6-S-B-12V	8 GPM	3000 PSI	SAE8	12 VDC	Closed
KV-2/2-6-S-B-24V	8 GPM	3000 PSI	SAE8	24 VDC	Closed
KV-2/2-6-S-A-110V	8 GPM	3000 PSI	SAE8	110 VAC	Open
KV-2/2-6-S-B-110V	8 GPM	3000 PSI	SAE8	110 VAC	Closed

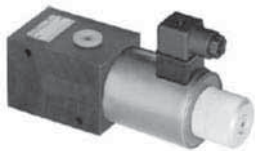

KVC-3/2-10
SELECTOR VALVE 3 WAY'S 2 POSITIONS

12 & 24 VDC, 16 & 26 GPM

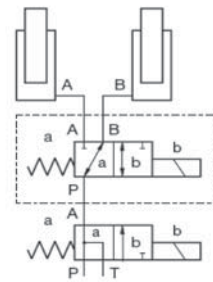
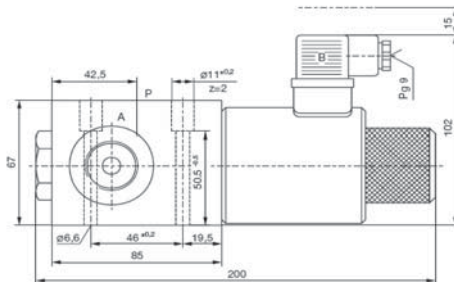

MODEL	MAX. GPM	MAX. PRESSURE	PORTS	VOLTAGE
KVC-3/2-10-S-41B-12V	16	5000 PSI*	SAE8	12 VDC
KVC-3/2-10-S-41B-24V	16	5000 PSI*	SAE8	24 VDC
KVC-3/2-100-S-41B-24V	26*	5000 PSI*	SAE10	12 VDC
KVC-3/2-100-S-41B-24V	26*	5000 PSI*	SAE10	24 VDC

* With case drain.



KV-6/2-6
SELECTOR VALVE 6 WAYS / 2 POSITIONS

12 & 24 VDC, 13 & 32 GPM

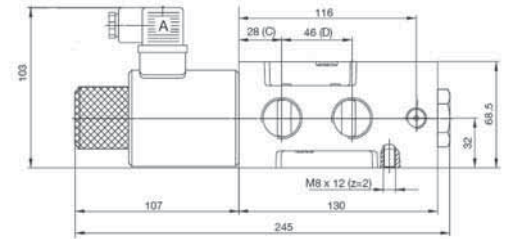
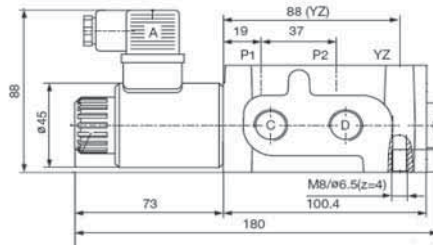
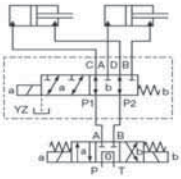

MODEL	MAX. GPM	MAX. PRESSURE	PORTS	VOLTAGE
KV-6K/2-6-12V	13	3625 PSI	SAE6	12 or 24 VDC
KV-6/2-6-12V	13	5000 PSI*	SAE8	12 VDC
KV-6/2-6-24V	13	5000 PSI*	SAE8	24 VDC
KV-6/2-10-12V	32	5000 PSI*	SAE10	12 VDC
KV-6/2-10-24V	32	5000 PSI*	SAE10	24 VDC

* 5000 PSI with drain.



KV-6/2-16-XN
SELECTOR VALVE 6 WAYS / 2 POSITIONS

12 & 24 VDC, 66 GPM

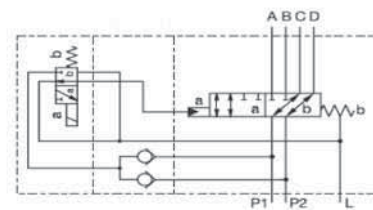
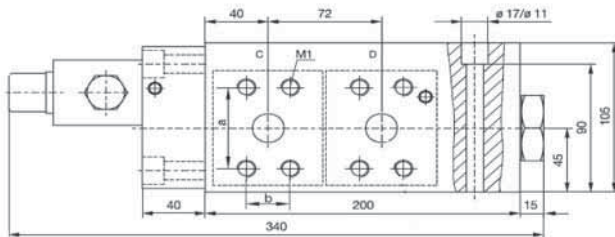

MODEL	MAX. GPM	MAX. PRESSURE	PORTS	VOLTAGE
KV-6/2-16-12V-XN	66	5000 PSI	1" code 62 with bolts M12	12 VDC
KV-6/2-16-24V-XN	66	5000 PSI	1" code 62 with bolts M12	24 VDC

SAE16 available upon request.

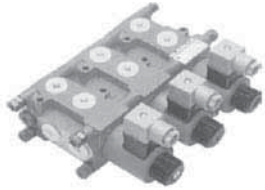

**KVH-6/2-6 & KVH-6/2-10
STACKABLE SELECTOR VALVE
6 WAYS, 2 POSITIONS (PER SECTION)**

12 VDC, 13 & 32 GPM

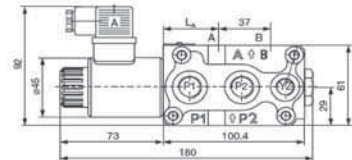
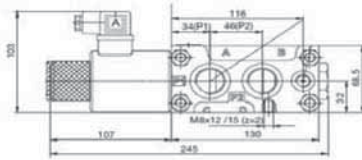
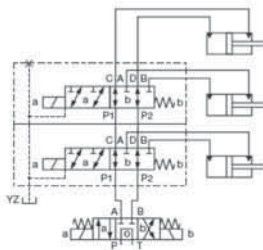

MODEL	MAX. GPM	MAX. PRESSURE	PORTS	VOLTAGE
KVH-6/2-6-N1-12V-YZ (1 section)	13	4600 PSI*	SAE8 (3/4"-16 UNF)	12 VDC
KVH-6/2-6-N2-12V-YZ (2 sections)	13	4600 PSI*	SAE8 (3/4"-16 UNF)	12 VDC
KVH-6/2-6-N3-12V-YZ (3 sections)	13	4600 PSI*	SAE8 (3/4"-16 UNF)	12 VDC
KVH-6/2-6-N4-12V-YZ (4 sections)	13	4600 PSI*	SAE8 (3/4"-16 UNF)	12 VDC
KVH-6/2-10-N1-12V-YZ (1 sections)	32	4600 PSI*	SAE10 (7/8"-14 UNF)	12 VDC
KVH-6/2-10-N2-12V-YZ (2 sections)	32	4600 PSI*	SAE10 (7/8"-14 UNF)	12 VDC
KVH-6/2-10-N3-12V-YZ (3 sections)	32	4600 PSI*	SAE10 (7/8"-14 UNF)	12 VDC
KVH-6/2-10-N4-12V-YZ (4 sections)	32	4600 PSI*	SAE10 (7/8"-14 UNF)	12 VDC

* With drain.



50/50 DIVIDER/COMBINER VALVE

Divides flow 50/50 both ways.

MODEL	PORTS	MIN. INLET FLOW	MAX. INLET FLOW	MAX. PRESSURE
DTP-6-20-3/8	3/8"-18NPT	2 GPM	5.3 GPM	5000 PSI
DTP-6-35-SAE8	3/4"-16UNF (SAE8)	3 GPM	9.25 GPM	5000 PSI
DTP-6-50-SAE8	3/4"-16UNF (SAE8)	4.25 GPM	13.25 GPM	5000 PSI
DTP-10-70-SAE10	7/8"-14UNF (SAE10)	9.25 GPM	18.5 GPM	5000 PSI

See page 12 (CBF) for larger flow divider valves.

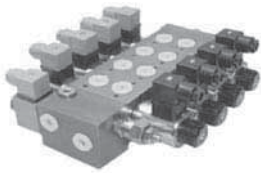

KVM-6 (MD06 STYLE)
SOLENOID ACTUATED DIRECTIONAL CONTROL VALVE STACKABLE
 10 GPM , 12 & 24 VDC

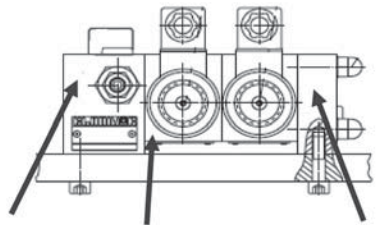
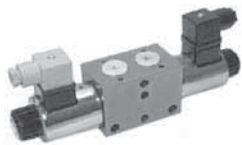

Entrance cover Section Exit Cover

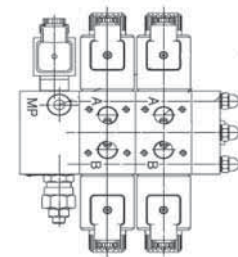

PARALLEL

MODEL	MAX. GPM	MAX. PRESSURE	PORTS P-T	PORTS A-B	VOLTAGE	NUMBER OF SECTIONS
KVM-P-4/3-6-1-12DC-N1	10	5000 PSI	SAE8 (3/4"-16 UNF)	SAE6 (9/16"-18 UNF)	12 VDC	1 section
KVM-P-4/3-6-1-12DC-N2	10	5000 PSI	SAE8 (3/4"-16 UNF)	SAE6 (9/16"-18 UNF)	12 VDC	2 sections
KVM-P-4/3-6-1-12DC-N3	10	5000 PSI	SAE8 (3/4"-16 UNF)	SAE6 (9/16"-18 UNF)	12 VDC	3 sections
KVM-P-4/3-6-1-12DC-N4	10	5000 PSI	SAE8 (3/4"-16 UNF)	SAE6 (9/16"-18 UNF)	12 VDC	4 sections
KVM-P-4/3-6-1-12DC-N5	10	5000 PSI	SAE8 (3/4"-16 UNF)	SAE6 (9/16"-18 UNF)	12 VDC	5 sections
KVM-P-4/3-6-1-12DC-N6	10	5000 PSI	SAE8 (3/4"-16 UNF)	SAE6 (9/16"-18 UNF)	12 VDC	6 sections
KVM-P-4/3-6-1-12DC-N7	10	5000 PSI	SAE8 (3/4"-16 UNF)	SAE6 (9/16"-18 UNF)	12 VDC	7 sections
KVM-P-4/3-6-1-12DC-N8	10	5000 PSI	SAE8 (3/4"-16 UNF)	SAE6 (9/16"-18 UNF)	12 VDC	8 sections

SERIE

MODEL	MAX. GPM	MAX. PRESSURE	PORTS P-T	PORTS A-B	VOLTAGE	NUMBER OF SECTIONS
KVM-S-4/3-6-2-12DC-N1	8	3625 PSI	SAE8 (3/4"-16 UNF)	SAE6 (9/16"-18 UNF)	12 VDC	1 section
KVM-S-4/3-6-2-12DC-N2	8	3625 PSI	SAE8 (3/4"-16 UNF)	SAE6 (9/16"-18 UNF)	12 VDC	2 sections
KVM-S-4/3-6-2-12DC-N3	8	3625 PSI	SAE8 (3/4"-16 UNF)	SAE6 (9/16"-18 UNF)	12 VDC	3 sections
KVM-S-4/3-6-2-12DC-N4	8	3625 PSI	SAE8 (3/4"-16 UNF)	SAE6 (9/16"-18 UNF)	12 VDC	4 sections

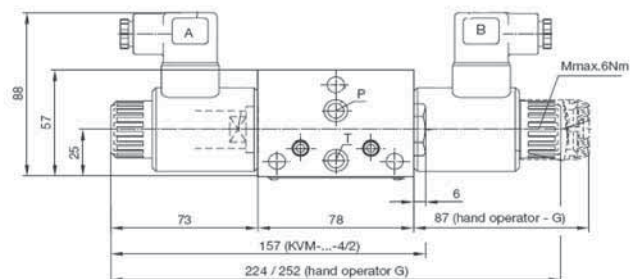
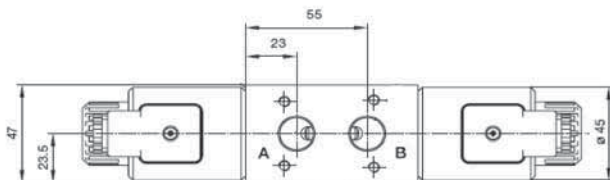



KV-8/3-6
2 SECTIONS MONOBLOCK SELECTOR VALVE
8 WAY, 3 POSITIONS
 13 GPM, 3625 PSI

MODEL	MAX. GPM	MAX. PRESSURE	PORTS	VOLTAGE
KV-8/3-6-12V	13	3625 PSI	SAE8	12 volt

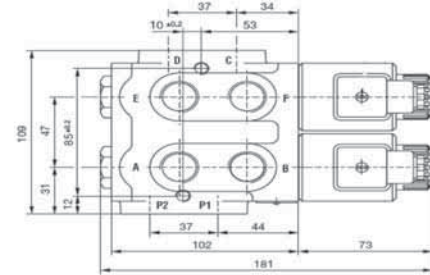
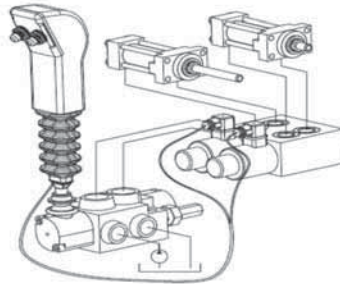
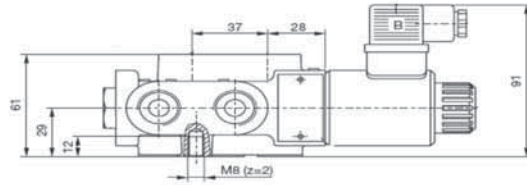
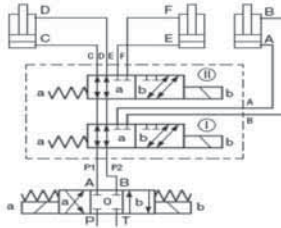

KRSS-C010
CONTROL LEVER C/W ELECTRIC BUTTONS
AVAILABLE WITH 1 OR 2 BUTTONS

MODEL	BUTTONS
KRSS-C010-A	1
KRSS-C010-B	2

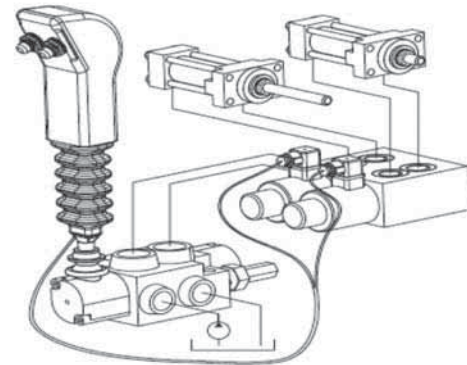
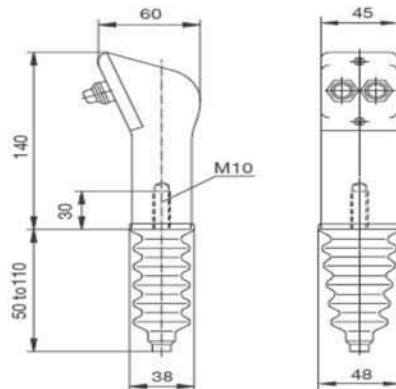

= A



= B

LOW SPEED, HIGH TORQUE (LSHT) HYDRAULIC MOTOR 1" KEY SHAFT, NPT OR SAE PORTS

MODEL	DISPLACEMENT P.C./REV.	MOUNTING	MAXIMUM RPM	MAX. TORQUE IN/LBS	HP	MAXIMUM PRESSURE PSI	MAXIMUM GPM	WEIGHT LBS
GBMP36-H4-C-P	2.19	4 bolts	1500 cont.	486 cont. 672 int. 849 peak	11.7 cont.	1812 cont. 2393 int. 3263 peak	14.55 cont.	12.32
GBMP36-2-C-P		2 bolts SAEA	1650 int.	15.4 int.	16 int.			
GBMP50-H4-C-P	3.15	4 bolts	1150 cont.	885 cont. 1132 int. 1309 peak	13.4 cont.	2030 cont. 2538 int. 3263 peak	16 cont.	12.32
GBMP50-2-C-P		2 bolts SAEA	1450 int.	16 int.	20 int.			
GBMP80-H4-C-P	4.74	4 bolts	770 cont.	1292 cont. 1646 int. 1929 peak	13.4 cont.	2030 cont. 2538 int. 3263 peak	16 cont.	12.54
GBMP80-2-C-P		2 bolts SAEA	960 int.	16 int.	20 int.			
GBMP100-H4-C-P	5.87	4 bolts	615 cont.	1610 cont. 2009 int. 2336 peak	14.75 cont.	2030 cont. 2538 int. 3263 peak	16 cont.	12.98
GBMP100-2-C-P		2 bolts SAEA	770 int.	17.4 int.	20 int.			
GBMP125-H4-C-P	7.33	4 bolts	490 cont.	2088 cont. 2566 int. 3186 peak	13.4 cont.	2030 cont. 2538 int. 3263 peak	16 cont.	13.2
GBMP125-2-C-P		2 bolts SAEA	615 int.	16 int.	20 int.			
GBMP160-H4-C-P	9.59	4 bolts	383 cont.	2672 cont. 3274 int. 3841 peak	13.4 cont.	2030 cont. 2538 int. 3263 peak	16 cont.	13.64
GBMP160-2-C-P		2 bolts SAEA	475 int.	16 int.	20 int.			
GBMP200-H4-C-P	11.86	4 bolts	310 cont.	3186 cont. 3894 int. 4779 peak	13.4 cont.	2030 cont. 2538 int. 3263 peak	16 cont.	14.08
GBMP200-2-C-P		2 bolts SAEA	385 int.	16 int.	20 int.			
GBMP250-H4-C-P	14.66	4 bolts	250 cont.	3363 cont. 4071 int. 4867 peak	11.4 cont.	1595 cont. 2030 int. 2610 peak	16 cont.	15.4
GBMP250-2-C-P		2 bolts SAEA	310 int.	14 int.	20 int.			
GBMP315-H4-C-P	19.19	4 bolts	192 cont.	3319 cont. 4912 int. 5752 peak	9.4 cont.	1305 cont. 2030 int. 2320 peak	16 cont.	15.4
GBMP315-2-C-P		2 bolts SAEA	240 int.	11.4 int.	20 int.			
GBMP400-H4-C-P	23.76	4 bolts	155 cont.	3186 cont. 4646 int. 6018 peak	8 cont.	1015 cont. 1522 int. 2030 peak	16 cont.	16.28
GBMP400-2-C-P		2 bolts int.	190 int.	9.4 int.	20 int.			

Cont. (Continuous)= 100% operation

Int. (Intermittent)= 6 sec./min.

Peak= 0.6 sec./min.

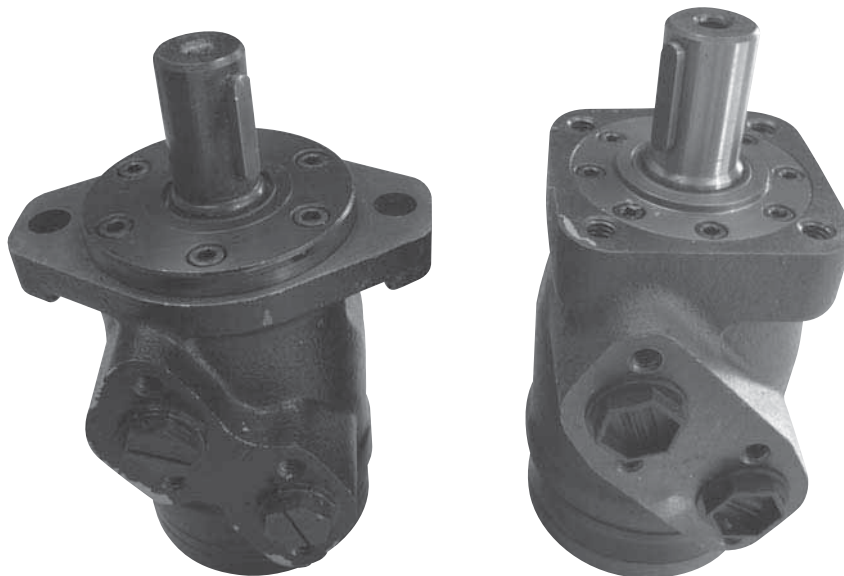

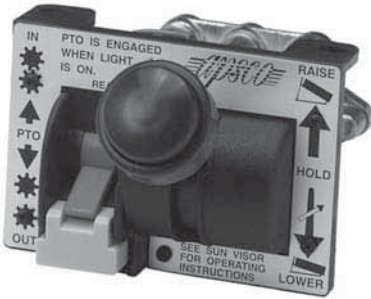

AV295

PTO/DUMP PUMP combo pneumatic valve, automatic disengagement of PTO in «lower» position

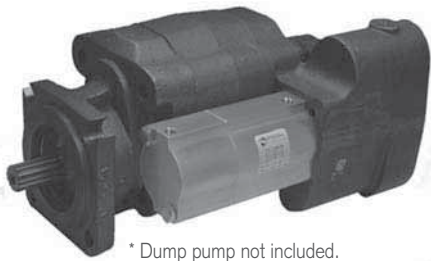

C-3505-DM

Pneumatic actuator for dump pump*



VM-7

Stackable proportional controls, straight, left & right levers 0-100 PSI proportional



VM-10

Quad control valve
0-100 PSI proportional

HIGH PRESSURE BALL VALVE



TYPE	AVAILABLE PORTS		MAX. FLOW	MAX. PRESSURE
	NPT	SAE	GPM	PSI
RSAP2V01	1/4"	9/16"-18	4 GPM	7350 PSI
RSAP2V02	3/8"	3/4"-16	8 GPM	7350 PSI
RSAP2V03	1/2"	7/8"-14	16 GPM	7350 PSI
RSAP2V04	3/4"	1 1/16"-12	21 GPM	5500 PSI
RSAP2V05	1"	1 5/16"-12	33 GPM	5000 PSI
RSAP2V06	1 1/4"	1 5/8"-12	33 GPM	4000 PSI
RSAP2V07	1 1/2"	1 7/8"-12	33 GPM	3600 PSI

3 WAY HIGH PRESSURE BALL VALVE

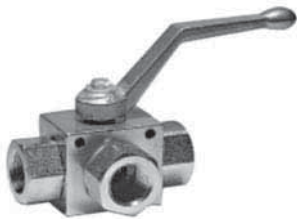

TYPE	AVAILABLE PORTS		MAX. FLOW	MAX. PRESSURE
	NPT	SAE	GPM	PSI
RSAP3V01	1/4"	9/16"-18	4 GPM	5800 PSI
RSAP3V02	3/8"	3/4"-16	8 GPM	5800 PSI
RSAP3V03	1/2"	7/8"-14	16 GPM	5000 PSI
RSAP3V04	3/4"	1 1/16"-12	21 GPM	4200 PSI
RSAP3V05	1"	1 5/16"-12	33 GPM	3600 PSI

3 WAY, ROTARY ACTUATED SELECTOR VALVE



TYPE	AVAILABLE PORTS		MAX. FLOW	MAX. PRESSURE
	NPT	SAE	GPM	PSI
DDF3V02	3/8"	3/4"-16	16 GPM	4300 PSI
DDF3V03	1/2"	7/8"-14	24 GPM	4000 PSI
DDF3V04	3/4"	1 1/16"-12	32 GPM	3600 PSI
DDF3V05	1"	1 5/16"-12	48 GPM	3100 PSI

Anti-corrosion treatment available.

3 WAY, HIGH PRESSURE, ROTARY ACTUATED SELECTOR VALVE



TYPE	AVAILABLE PORTS		MAX. FLOW	MAX. PRESSURE
	NPT	SAE	GPM	PSI
DDF3VAP02	3/8"	3/4"-16	16 GPM	6525 PSI
DDF3VAP03	1/2"	7/8"-14	24 GPM	5800 PSI
DDF3VAP04	3/4"	1 1/16"-12	32 GPM	5075 PSI
DDF3VAP05	1"	1 5/16"-12	48 GPM	5075 PSI



ROTARY ACTUATED 6 WAY SELECTOR VALVE

TYPE	AVAILABLE PORTS		MAX. FLOW	MAX. PRESSURE
	NPT	SAE	GPM	PSI
DDF6V02	3/8"	3/4"-16	16 GPM	4300 PSI
DDF6V03	1/2"	7/8"-14	24 GPM	4000 PSI
DDF6V04	3/4"	1 1/16"-12	32 GPM	3600 PSI
DDF6V05	1"	1 5/16"-12	48 GPM	3100 PSI

Anti-corrosion treatment available.



ROTARY ACTUATED 4 WAY SELECTOR VALVE

TYPE	AVAILABLE PORTS		MAX. FLOW	MAX. PRESSURE
	NPT	SAE	GPM	PSI
IDF4V02	3/8"	3/4"-16	9 GPM	4000 PSI
IDF4V03	1/2"	7/8"-14	13 GPM	3600 PSI
IDF4V04	3/4"	1 1/16"-12	24 GPM	3100 PSI

Anti-corrosion treatment available.



ROTARY ACTUATED 8 WAY SELECTOR VALVE

TYPE	AVAILABLE PORTS		MAX. FLOW	MAX. PRESSURE
	NPT	SAE	GPM	PSI
IDF8V02	3/8"	3/4"-16	9 GPM	4000 PSI
IDF8V03	1/2"	7/8"-14	13 GPM	3600 PSI
IDF8V04	3/4"	1 1/16"-12	24 GPM	3100 PSI

Anti-corrosion treatment available.



IN-LINE CHECK VALVE

TYPE	AVAILABLE PORTS		MAX. FLOW	MAX. PRESSURE
	NPT	SAE	GPM	PSI
VUR01	1/4"	9/16"-18	6.6 GPM	5800 PSI
VUR02	3/8"	3/4"-16	10.5 GPM	5800 PSI
VUR03	1/2"	7/8"-14	21 GPM	5000 PSI
VUR04	3/4"	1 1/16"-12	29 GPM	4300 PSI
VUR05	1"	1 5/16"-12	37 GPM	4000 PSI
VUR06	1 1/4"	1 5/8"-12	53 GPM	3600 PSI
VUR07	1 1/2"	1 7/8"-12	80 GPM	3300 PSI

Cracking pressure 5 PSI or 65 PSI

DOUBLE PILOT OPERATED LOCK VALVE



TYPE	ORIFICES DISPONIBLE		DÉBIT MAX. GPM	PRESSION MAX. PSI
	NPT	SAE		
VPDE01	1/4"	9/16"-18	5 GPM	5075 PSI
VPDE02	3/8"	3/4"-16	10.5 GPM	5075 PSI
VPDE03	1/2"	7/8"-14	17 GPM	4350 PSI

In-line mounted.

DOUBLE PILOT OPERATED LOCK VALVE



TYPE	AVAILABLE PORTS		MAX. FLOW GPM	MAX. PRESSURE PSI
	NPT	SAE		
VRDE01F	1/4"	9/16"-18	5 GPM	5075 PSI
VRDE02F	3/8"	3/4"-16	13 GPM	5075 PSI
VRDE03F	1/2"	7/8"-14	21 GPM	4350 PSI
VRDE04F	3/4"	1 1/16"-12	31 GPM	4350 PSI

SINGLE PILOT OPERATED LOCK VALVE



TYPE	AVAILABLE PORTS		MAX. FLOW GPM	MAX. PRESSURE PSI
	NPT	SAE		
VBPS01	1/4"	9/16"-18	4 GPM	4640 PSI
VBPS02	3/8"	3/4"-16	9 GPM	4640 PSI
VBPS03	1/2"	7/8"-14	12 GPM	4350 PSI
VBPS04	3/4"	1 1/16"-12	21 GPM	3625 PSI

VELOCITY FUSE (HOSE BURST VALVE)



TYPE	AVAILABLE PORTS		MAX. FLOW GPM	MAX. PRESSURE PSI
	NPT	SAE		
VUBA01	1/4"	9/16"-18	6 GPM	5000 PSI
VUBA02	3/8"	3/4"-16	12 GPM	5000 PSI
VUBA03	1/2"	7/8"-14	18.5 GPM	5000 PSI
VUBA04	3/4"	1 1/16"-12	37 GPM	4350 PSI
VUBA05	1"	1 5/16"-12	48 GPM	3100 PSI

PILOT OPERATED LOCK VALVE WITH MANUAL BY-PASS



TYPE	AVAILABLE PORTS		MAX. FLOW GPM	MAX. PRESSURE PSI
	NPT	SAE		
VRPSE-01	1/4"	-	7 GPM	5000 PSI
VRPSE-015	3/8"	9/16"-18	7 GPM	5000 PSI
VRPSE-02	3/8"	3/4"-16	13 GPM	4350 PSI

SHUTTLE VALVE



TYPE	AVAILABLE PORTS		MAX. FLOW	MAX. PRESSURE
	NPT	SAE	GPM	PSI
VU-SF01	1/4"	9/16"-18	5.3 GPM	7250 PSI
VU-SF02	3/8"	3/4"-16	12 GPM	7250 PSI
VU-SF03	1/2"	7/8"-14	21 GPM	7250 PSI
VU-SF04	3/4"	1 1/16"-12	29 GPM	5000 PSI
VU-SF05	1"	1 5/16"-12	40 GPM	4350 PSI

NEEDLE VALVE



TYPE	AVAILABLE PORTS		MAX. FLOW	MAX. PRESSURE
	NPT	SAE	GPM	PSI
VRFB9001	1/4"	9/16"-18	4 GPM	5000 PSI
VRFB9002	3/8"	3/4"-16	8 GPM	5000 PSI
VRFB9003	1/2"	7/8"-14	12 GPM	5000 PSI
VRFB9004	3/4"	1 1/16"-12	21 GPM	4350 PSI

Control both ways.

FLOW CONTROL VALVE



TYPE	AVAILABLE PORTS		MAX. FLOW	MAX. PRESSURE
	NPT	SAE	GPM	PSI
VRFU9001	1/4"	9/16"-18	4 GPM	5000 PSI
VRFU9002	3/8"	3/4"-16	8 GPM	5000 PSI
VRFU9003	1/2"	7/8"-14	12 GPM	5000 PSI
VRFU9004	3/4"	1 1/16"-12	18 GPM	4350 PSI
VRFU9005	1"	-	20 GPM	4350 PSI

Uni-directional.

IN-LINE FLOW CONTROL VALVE



TYPE	AVAILABLE PORTS		MAX. FLOW	MAX. PRESSURE
	NPT	SAE	GPM	PSI
VRF01	1/4"	9/16"-18	4 GPM	5000 PSI
VRF02	3/8"	3/4"-16	8 GPM	5000 PSI
VRF03	1/2"	7/8"-14	12 GPM	5000 PSI
VRF04	3/4"	1 1/16"-12	21 GPM	4350 PSI
VRF05	1"	1 5/16"-12	29 GPM	3600 PSI
VRF06	1 1/4"	1 5/8"-12	40 GPM	3100 PSI
VRF07	1 1/2"	1 7/8"-12	56 GPM	2900 PSI

Controls on way, free reverse flow.

IN-LINE ROTARY ADAPTOR (SUPER SWIVEL STYLE)



TYPE	AVAILABLE PORTS		MAX. FLOW	MAX. PRESSURE
	NPT	SAE	GPM	PSI
GGIL01	1/4"	9/16"-18	6 GPM	5800 PSI
GGIL02	3/8"	3/4"-16	12 GPM	5800 PSI
GGIL03	1/2"	7/8"-14	21 GPM	5200 PSI
GGIL04	3/4"	1 1/16"-12	32 GPM	4600 PSI
GGIL05	1"	1 5/16"-12	48 GPM	4000 PSI
GGIL06	1 1/4"	1 5/8"-12	52 GPM	3600 PSI
GGIL07	1 1/2"	1 7/8"-12	66 GPM	2900 PSI
GGIL09N	2"	-	80 GPM	2610 PSI

90 DEGREE ROTARY ADAPTOR (SUPER SWIVEL STYLE)



TYPE	AVAILABLE PORTS		MAX. FLOW	MAX. PRESSURE
	NPT	SAE	GPM	PSI
GG9001	1/4"	9/16"-18	6 GPM	5800 PSI
GG9002	3/8"	3/4"-16	12 GPM	5800 PSI
GG9003	1/2"	7/8"-14	21 GPM	5200 PSI
GG9004	3/4"	1 1/16"-12	32 GPM	4600 PSI
GG9005	1"	1 5/16"-12	40 GPM	4000 PSI
GG9006	1 1/4"	1 5/8"-12	52 GPM	3600 PSI
GG9007	1 1/2"	1 7/8"-12	66 GPM	2900 PSI
GG9009N	2"	-	80 GPM	2610 PSI

SEQUENCE VALVE



TYPE	AVAILABLE PORTS		MAX. FLOW	MAX. PRESSURE
	NPT	SAE	GPM	PSI
VS3502	3/8"	3/4"-16	10 GPM	5000 PSI
VS3503	1/2"	7/8"-14	10 GPM	5000 PSI



GALTECH CANADA CUSHION VALVE STEEL BODY



MODEL	DESCRIPTION	PORTS	PRESSURE ADJUST. RANGE	ADJUSTMENT TYPE	MAX. GPM	MAX. PRESSURE
STCR38-2000	Single cushion	3/8" NPT	1200-2900 PSI	Hex	12 GPM	5000 PSI
STCR50-2000	Single cushion	1/2" NPT	1200-2900 PSI	Hex	12 GPM	5000 PSI
STCC38-2000	Double cushion	3/8" NPT	1200-2900 PSI	Hex	12 GPM	5000 PSI
STCC50-2000	Double cushion	1/2" NPT	1200-2900 PSI	Hex	16 GPM	5000 PSI
STCC08-2000	Double cushion	SAE8 (3/4"-16UNF)	1200-2900 PSI	Hex	16 GPM	5000 PSI
STCC10-2000	Double cushion	SAE10 (7/8"-14UNF)	1200-2900 PSI	Hex	22 GPM	5000 PSI
STCC12-2000	Double cushion	SAE12 (1 1/16"-12UNF)	1200-2900 PSI	Hex	22 GPM	5000 PSI

Other pressure adjustment available upon request.

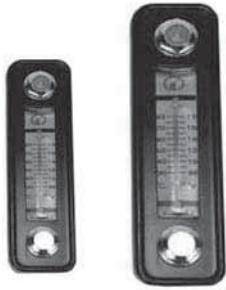

OIL LEVEL INDICATOR WITH THERMOMETER

MODEL	CENTER	TEMPERATURE
LS-3	3"	With thermometer
LS-5	5"	With thermometer
LA-10	10"	With thermometer



OIL BREATHER CAP

MODEL	STYLE	REFINING
1013	Push on	40 microns



NPT, 40 MICRONS THREADED FILLER BREATHER

MODEL	THREAD	REFINING
AB-06-02	1/4" NPT	40 microns
AB-06-03	3/8" NPT	40 microns
AB-12-04	1/2" NPT	40 microns
AB-12-06	3/4" NPT	40 microns
AB-12-08	1" NPT	40 microns



WELDED FILLER BREATHER WITH BASKET 40 MICRONS

MODEL	FIXATION	REFINING
FB-18	Welded type	40 microns



FILLER BREATHER- BAYONET STYLE 40 MICRONS

MODEL	FIXATION	REFINING
FB-12	With bolts	40 microns

SUCTION STRAINER

(100 mesh)

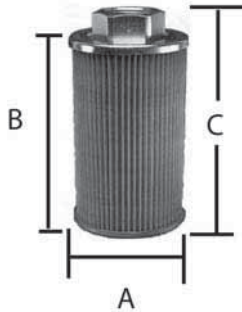

MODEL	CONNECTION	A	B	C	MAX. FLOW
SFF-02	1/4" NPT	1.69"	1.97"	2.36"	4 GPM
SFF-03	3/8" NPT	1.69"	1.97"	2.36"	4 GPM
SFF-04	1/2" NPT	2.36"	3.94"	4.41"	9 GPM
SFF-06	3/4" NPT	2.36"	5.12"	5.71"	14.5 GPM
SFF-08	1" NPT	2.64"	5.71"	6.38"	29 GPM
SFF-10	1 1/4" NPT	2.87"	6.93"	7.64"	55 GPM
SFF-12	1 1/2" NPT	3.43"	7.52"	8.23"	75 GPM
SFF-16	2" NPT	4.21"	7.99"	8.82"	104 GPM
SFF-20	2 1/2" NPT	6.30"	13.70"	14.57"	198 GPM
SFF-24	3" NPT	6.30"	13.70"	14.57"	211 GPM

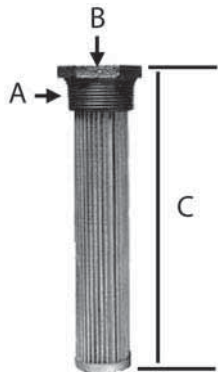

TANK MOUNTED STRAINER

(100 mesh)

MODEL	A (MALE)	B (FEMELLE)	C (POUCE)
TMF03	3/4" NPT	3/8" NPT	4"
TMF05	1" NPT	1/2" NPT	5.34"
TMF10	1 1/4" NPT	3/4" NPT	8.17"
TMF15	1 1/2" NPT	1" NPT	8.20"
TMF25	2" NPT	1 1/4" NPT	9.04"
TMF50	3" NPT	2" NPT	9.70"
TMF100	4" NPT	3" NPT	11.30"

SPIN-ON FILTER ELEMENT



MODEL	HEAD TYPE	FILTRATION	TYPE
BT 839	1/2" @ 3/4"	25 microns	Short
BT 839-10	1/2" @ 3/4"	10 microns	Short
BT 287	1 1/4"	25 microns	Short
BT 287-10	1 1/4"	10 microns	Short
BT 389	1 1/4"	25 microns	Long
BT 389-10	1 1/4"	10 microns	Long
B7011	1 1/4"	3 microns	Long

PUMP/MOTOR ADAPTOR (ELECTRIC & GAS)



MODEL	MOTOR TYPE	MOTOR SIZE	BOLT CIRCLE MOTOR SIDE	PUMP PILOT DIAMETER	LENGHT FACE TO FACE
PAE-56C-4F17-425	Electric	56C @ 145TC	5.875"	1.75" & 2" (4F14 & SAEAA)	4.25"
PAE-56C-SAEA-425	Electric	56C @ 145TC	5.875"	3.25" (SAEA)	4.25"
PAE-184TC-4F17-525	Electric	182TC @ 256TC	7.25"	1.78" & 2" (4F17 & SAEAA)	5.25"
PAE-184TC-SAEA-500	Electric	184TC @ 256TC	7.25"	3.25" (SAEA)	5.00"
256-588-825	Electric	184TC @ 256TC	7.25"	3.25" (SAEA)	5.88"
PAG-5.5/6.5HP-4F17-443	Gas	5.5 & 6.5HP	3.625"	1.78" & 2" (4F17 & SAEAA)	4.43"
PAG-5.5/6.5HP-SAEA-480	Gas	5.5 & 6.5HP	3.625"	3.25" (SAEA)	4.80"
PAG-8/20HP-4F17-575	Gas	8 @ 20HP	6.5"	1.78" & 2" (4F17 & SAEAA)	5.75"
PAG-8/20HP-SAEA-575	Gas	8 @ 20HP	6.5"	3.25" (SAEA)	5.75"

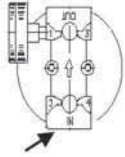

HEAD FOR (SPIN-ON) ELEMENT

MODEL	PORTS	BY-PASS	GAUGE PORTS (2)
T05V1R	3/4" NPT	25 PSI	Available
T10V1R	1 1/4" NPT	25 PSI	Available



TANK TOP FILTER

MODEL	PORTS	BY-PASS	FILTRATION	MAX. FLOW
OMTF 091 NB1	1/2" NPT	25 PSI	10 or 25 microns	10.5 GPM
OMTF 091 NB2	SAE8	25 PSI	10 or 25 microns	10.5 GPM
OMTF 111 NB7	SAE12	25 PSI	10 or 25 microns	21.5 GPM
OMTF 111 NB8	SAE16	25 PSI	10 or 25 microns	21.5 GPM
OMTF 112 NB8	SAE16	25 PSI	10 or 25 microns	26.5 GPM
OMTF 171 NB5	SAE20	25 PSI	10 or 25 microns	56.6 GPM
OMTF 222 NB7	SAE24	25 PSI	10 or 25 microns	92.5 GPM
OMTF 224 NB7	SAE24	25 PSI	10 or 25 microns	132.28 GPM

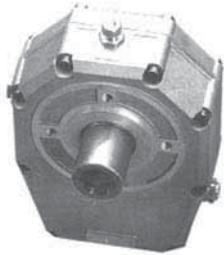

SPEED INCREASER

(To be combined with our Galtech pumps) For PTO 540 RPM (shaft 1 3/8" - 6 teeth) (p.7 & 8).

MODEL	INPUT RPM	OUTPUT RPM	RATIO	HP	TO USE WITH PUMP	SHAFT
60004-5	540 RPM	1890 RPM	3.5:1	13.4	Group 2 SP	Fem. «Quick»
70004-3	540 RPM	1350 RPM	2.5:1	27	Group 2 & 3 SP	Fem. «Quick»
70004-5	540 RPM	1890 RPM	3.5:1	27	Group 2 & 3 SP	Fem. «Quick»
70011-5	540 RPM	1890 RPM	3.5:1	27	Group 2 & 3 SP	Fem. + mâle
80003-8	540 RPM	2160 RPM	4:1	48	Group 3 SP	Fem. «Quick»

Other models available upon request. Borelli 8000 Serie.



12 VDC ELECTROMAGNETIC CLUTCH

(To be combined with our Galtech pumps) (p.7 & 8).

MODEL	MAX. RPM	PULLEY TYPE	TO USE WITH PUMPS
30929/SA	5000 RPM	«Vbelt»	Group 2 SP
30929/SB	5000 RPM	«Vbelt»	Group 3 SP
30929-1/SA	5000 RPM	Multigroove	Group 2 SP
30929-1/SB	5000 RPM	Multigroove	Group 3 SP

Other models available upon request.

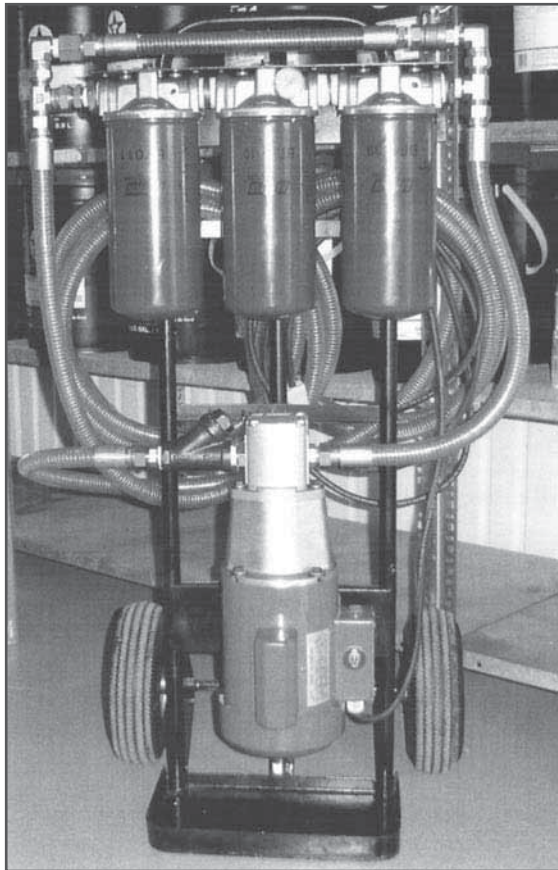

FILTER CART

Sample code : GCUF 1 110 8 BV 25 10 3

GCUF	1	110	BV	25 10 3
↓	↓	↓	↓	↓
FILTER CART GALTECH	↓	↓	↓	↓
MOTOR 1/3 @ 2 HP	↓	↓	↓	↓
VOLTAGE 110 or 220 Volts 1 phase	↓	↓	↓	↓
				FILTER ELEMENTS 25 = 25 microns nominal 10 = 10 microns nominal 3 = 3 microns nominal E/H = Water/oil separator ---- = No element
				DIVERTER VALVE BV = Low press ball valve D3V = 3/2 manual valve ---- = No valve

All units include :

- Steel cart on pneumatic wheels
- ON/OFF switch & 10' cable
- 3/4" diameter transparent suction hose, 15' lg, with «Y» adaptor and strainers
- 3/4" diameter transparent return hose, 15' lg
- Condition indicator gauge on each filter head

Other options available upon request.

DESIGN & MANUFACTURING POWER UNITS AS PER CUSTOMER SPECIFICATIONS

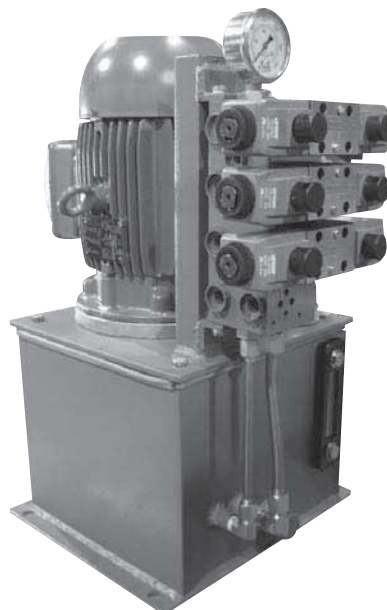

USEFUL EQUATIONS AND CONVERSIONS

PSI = Pounds per square inch
GPM = Gallons per minute
HP = Power
T = Torque (presented as feet pound)
RPM = Revolution per minute

DETERMINE THE HP REQUIRED

HP = $\text{PSI} \times \text{GPM} \div 1714$

CONNECTION BETWEEN TORQUE AND HP

T = $\text{HP} \times 5252 \div \text{RPM}$

HP = $\text{T} \times \text{RPM} \div 5252$

RPM = $\text{HP} \times 5252 \div \text{T}$

CONVERTING CUBIC INCHES IN GPM

$\text{Cu.i} \div 231 \times 1800 \text{ (RPM)} = \text{GPM @ 1800 RPM}$

CONVERTING CC PER MINUTE IN GPM

$\text{CC} \div 16.39 \div 231 \times 1800 \text{ (RPM)} = \text{GPM @ 1800 RPM}$

MESURING TABLE FOR THREAD (NPT AND SAE)			
HEIGHT	NPT	ORB-SAE	#
1/8"	1/8"-27"	5/16"-24	-2
1/4"	1/4"-18"	7/16"-20	-4
5/16"	-	1/2"-20	-5
3/8"	3/8"-18"	9/16"-18	-6
1/2"	1/2"-14"	3/4"-16	-8
5/8"	-	7/8"-14	-10
3/4"	3/4"-14"	1 1/16"-12	-12
7/8"	-	1 3/16"-12	-14
1"	1"-11 1/2"	1 5/16"-12	-16
1 1/4"	1 1/4"-11 1/2"	1 5/8"-12	-20
1 1/2"	2"-11 1/2"	1 7/8"-12	-24
2"	2"-11 1/2"	2 1/2"-12	-32

TUBE DIAMETER RECOMMENDED FOR MAXIMUM GPM

1/4" = 8 GPM
3/8" = 15 GPM
1/2" = 24 GPM
3/4" = 41 GPM
1" = 68 GPM
1 1/4" = 117 GPM

CONVERSIONS		
CONVERT	IN	MULTIPLY BY
IN	CONVERT	DIVIDE BY
BAR	PSI	14.7
CM	METER	0.01
CM	MM	10
GALLON	CUBIC INCH	231
GALLON	PINT	8
HP	LBS-FEET/MIN	33
KG	LITER	2.205
LITER	GALLON	0.2642
LITER	CUBIC INCH	61.02
CUBIC INCH	CUBIC INCH	61.023
FEET	METER	0.3048
INCH	CM	2.54
INCH	MM	25.4
CUBIC INCH	CC	16.39
TONNE	POUND	2000



SPECIALTY PRODUCTS

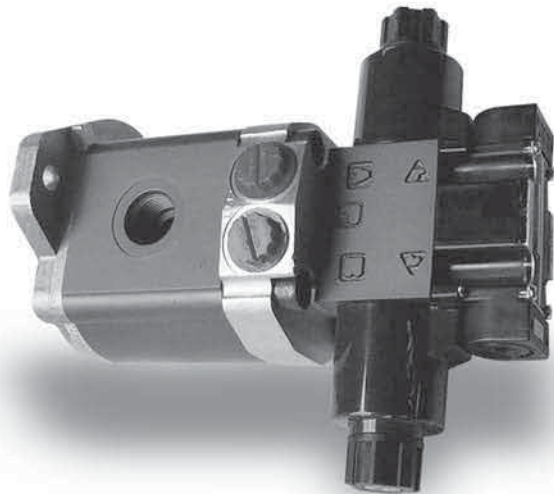
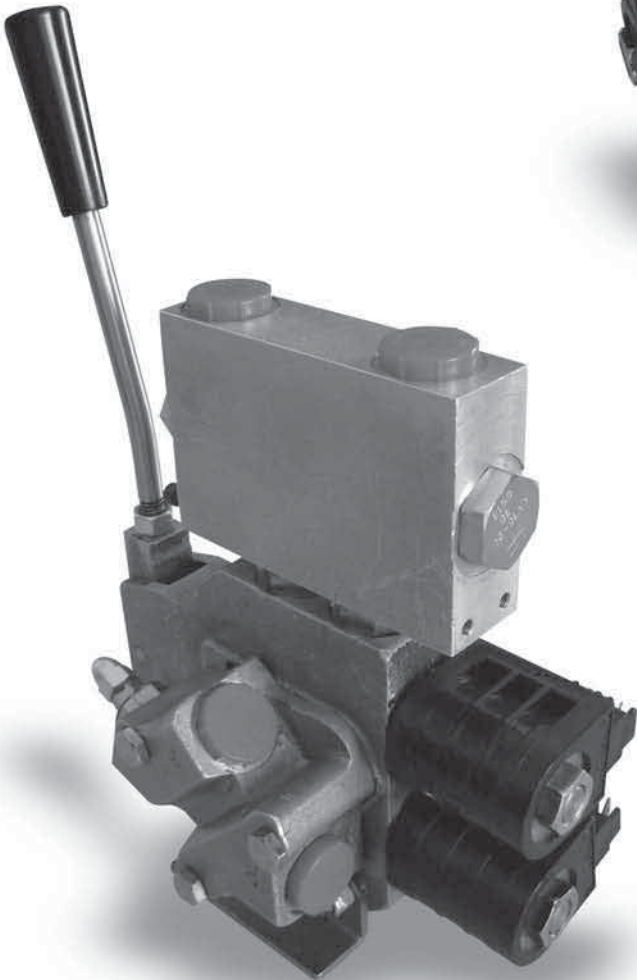
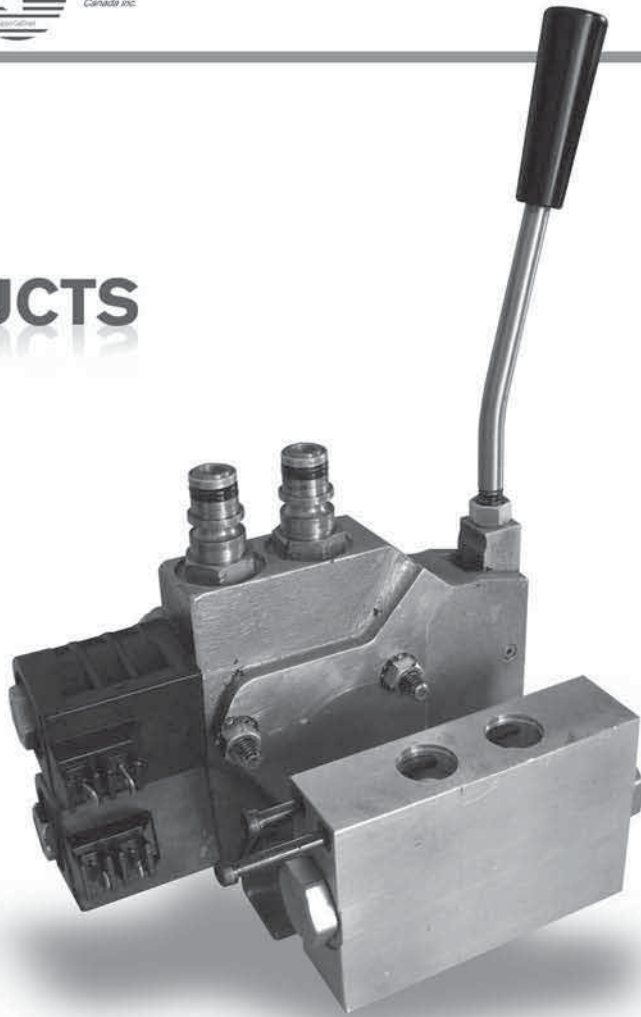

RECTO DE LA COUVERTURE ARRIÈRE
NE PAS IMPRIMER



Galtech Q80 valve

designed for
SNOW removal EQUIPMENT



Totally leakproof
Best warranty in the industry

Versatile options Load holding guaranteed



Other options available

- Progressive shift cable actuators
- 12 or 24 VDC actuators
- Nickel anti-corrosion treatment

Progressive shift stainless steel pneumatic actuator