



The Power of Innovation. For better Sterilization.  
Horizontal front loading bench-top autoclaves:  
SysTec D-Series  
Pass-through autoclaves: SysTec D-Series 2D

**Systec**

the autoclave company

# Systec D-Series: Bench-top autoclaves.

## Systec D-Series: Horizontal front loading bench-top autoclaves.

These autoclaves don't just seem to be different; they are different. Specially developed for sterilization procedures in the laboratory, processes become easier, safer, more precise, more reproducible and validatable.

Systec D-23

Systec D-45

Systec D-65

Systec D-90



### Dimensions and performance

Systec	D-23	D-45	D-65	D-90	D-100	D-150	D-200
Chamber dimensions Ø x depth in mm	260 x 420	344 x 500	400 x 500	400 x 700	500 x 500	500 x 750	500 x 1000
Chamber volume in liters total / nominal	25 / 23	50 / 45	70 / 65	95 / 90	110 / 100	160 / 150	210 / 200
External dimensions in mm							
W	555	618	750	750	850	850	850
H	500	550	930	630	730	730	730
D	650	740	770	970	810	1050	1300
Heating power kW							
Systec DX	2.80	2.80	9.00	9.00	9.00	9.00	9.00
Systec DE and DB	2.30	3.00	4.50	4.50	4.50	7.25	7.25

Electrical connections for Systec D-23 and D-45: 220 – 240V AC, 50/60 Hz, 16 A

Electrical connections for Systec D-65 – D-200: 380 – 400V, 50/60 Hz, 3-phase to neutral, 16 A

Other voltages and single-phase operation available on request

### Space advantage!

A compact instrument with ideal chamber size in seven sizes. Each size has an optimal loading capacity for most standard media bottles and Erlenmeyer flasks.

# A new dimension in technology and design.

Systec D-100

Systec D-150

Systec D-200



## Loading capacity\*

### Erlenmeyer flasks

Systec	D-23	D-45	D-65	D-90	D-100	D-150	D-200
250 ml	11	24	23	31	2 x 30	2 x 42	2 x 59
500 ml	8	12	15	21	2 x 15	2 x 24	2 x 40
1000 ml	3	8	9	13	12	18	23
2000 ml	-	3	6	8	7	9	14
3000 ml	-	-	3	4	6	8	11
5000 ml	-	-	-	-	3	5	7

## Loading capacity\*

### Schott-Duran media flasks

Systec	D-23	D-45	D-65	D-90	D-100	D-150	D-200
250 ml	18	24	31	40	2 x 36	2 x 54	2 x 83
500 ml	10	18	23	31	2 x 26	2 x 40	2 x 59
1000 ml	4	10	15	18	18	26	40
2000 ml	-	5	8	10	12	14	23
5000 ml	-	-	3	4	6	8	11
10000 ml	-	-	-	-	2	3	4

\*At max. loading, partially without baskets

# Autoclaves Systec D-series: Performance categories of the 3 series types.

X = Standard  
O = Optional

Horizontal front loading bench-top autoclaves Systec D-series	type	DX	DE	DB
From the sterilization chamber separated steam generator integrated into the housing		x		
Extension of temperature and pressure to 150 °C / 5bar (only for sizes Systec D-65 – D-150)		0	0	
Number of sterilization programs		25	12	3
Password secured access rights for parameterization and for further security relevant interventions		x	x	
Pre-programmable automatic door opening at the end of a program		x	x	
Additional PT-100 temperature sensor in the condense exhaust		x		
Rapid cooling		0	0	
Pre- and post-vacuum		0		
Air exhaust filtration		0	0	
Drying 'Superdry' (only in conjunction with an optional vacuum system)		0		
RS 232 and RS 485 for external data transfer (network-compatible)		x	x	
PC-Software for extensive documentation (network-compatible)		0	0	
Internal memory for documentation of up to 500 sterilization cycles		x	x	
Integrated SD-Card-Slot inclusive SD-Card (1024 MB) for data backup of up to 10.000 sterilization cycles and for transmission of process data to a PC via SD-Card reader		0	0	
Start by clock, Timer for programmable start time		x	x	
Steam exhaust condensation, water cooled, thermostatic controlled		x	x	
"Autofill" - Automatic de-mineralized water feed for steam generation		x	x	
Special program for waste sterilization with pulsed heat-up for more efficient air exhaust		x	x	x
Temperature holding function after the end of program for liquids		x	x	
Special program for Durham-Tubes		x	x	
Housing and basic frame construction out of corrosion resistant stainless steel		x	x	x
Prepared for subsequent rapid cooling installation		x	x	
Prepared for subsequent installation of vacuum system		x		
Prepared for subsequent drying installation		x		
Calculation of FO value		x	x	

Further options / Special programs (on request)  
Special accessories like baskets and inserts, lifting devices and wheels, available on request.



## Systemec D-Series autoclaves: Three types with different performance categories.

### **DX** Systemec DX

For all laboratory applications even for sophisticated state-of-the-art sterilization processes. With all possibilities to add additional options for process optimization to enable validatable sterilization to be carried out.

### **DE** Systemec DE

For basic laboratory applications and media sterilization. With limited possibilities to add additional options for process optimization.

### **DB** Systemec DB

For simple process applications. No options available for process optimization.



# Double-door (pass-through) autoclaves: Systec D-Series 2D.

**DX** Equipped with the same state-of-the-art technology as our horizontal front loading bench-top autoclave Systec D-Series, the 2D series has the same modern design but now with two doors for fitting between separating walls.

Systec  
DX-90 2D

Systec DX-150 2D / DX-200 2D



View from the non-sterile side



	Systec DX-90 2D	Systec DX-150 2D	Systec DX-200 2D
Chamber dimensions			
Ø x depth in mm	400 x 750	500 x 750	500 x 1000
Chamber volume in liters			
total / nominal	98 / 95	155 / 150	205 / 200

All types: heating power 9 kW, voltage 380 – 400 V, 50/60 Hz, 16 A.  
Modifications to other voltage as well as single phase operation available on request.

The loading capacities are the same as for the Systec D-90, Systec D-150 and Systec D-200 (see page 2).



View from the sterile side

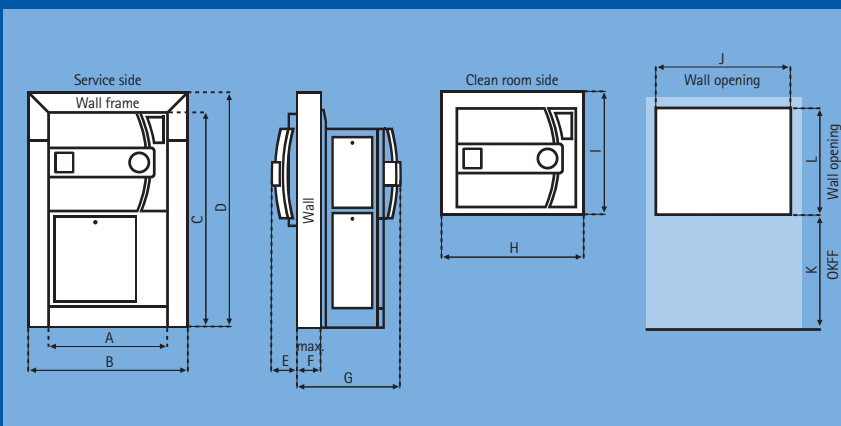

	Dimensions in mm		
	Systec DX-90 2D	Systec DX-150 2D	Systec DX-200 2D
A	750	850	850
B	1030	1130	1130
C	1430	1530	1530
D	1570	1670	1670
E	240	260	260
F	max. 200	max. 200	max. 200
G	900	900	1150
H	920	1020	1020
I	780	880	880
J	820	920	920
K	800	800	800
L	670	770	770

# A new dimension in technology and design.

## **DX** Triple safety aspects!

- One door only can be opened at any one time. If one door is open, the other is automatically locked.
- If the autoclave is switched off or if no current is available (e.g. power failure), both doors remain locked.
- If the door at the non-sterile side is opened, a sterilization program has to be performed before the door at the sterile side can be opened.

The locking system can be adapted to customers' wishes.

Doors and control panel are made of heat-insulating plastic, the housing completely of stainless steel and the edges specially processed for smooth junctions with walls.

Operation, however, can be carried out from both sides, the position (open or closed) of the opposite door being indicated on the display.

View from the sterile side



## For use under the most stringent clean room and safety conditions.

- For biological safety laboratories. Fitting as a sterilization and double-door (pass-through) lock for protecting the external environment.
- For clean rooms in laboratories and production facilities as a sterilization and double-door (pass-through) lock separating sterile and non-sterile areas.

Pass-through autoclave in cross-section build into dividing wall.



Clearly laid out control panel with membrane display. Door operated by an ergonomic handle.

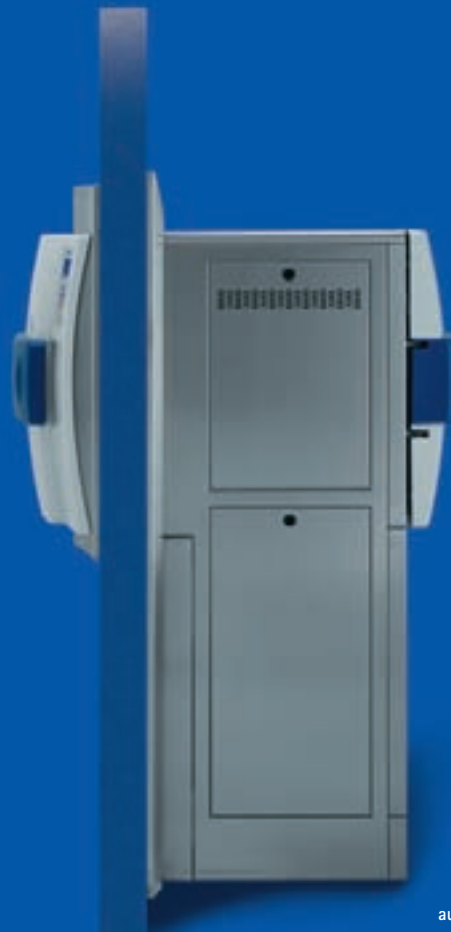

# Advanced technology, design and electronic intelligence!

Systec D-Series autoclaves are completely new designs: innovative mechanical and electronic components are incorporated and guarantee high sterilization quality in the laboratory. They thus fulfill those requirements that will ultimately be demanded of all laboratory sterilization processes in future, e.g. higher sterilization temperatures for work with prions.

Schematic illustration of the new door-locking system of the Systec D-65 – D-200.

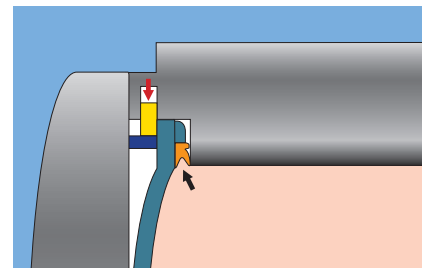
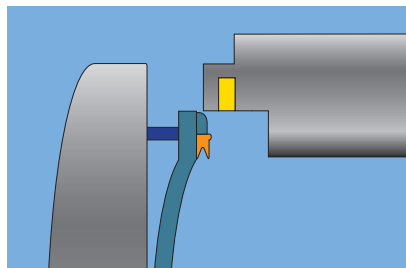
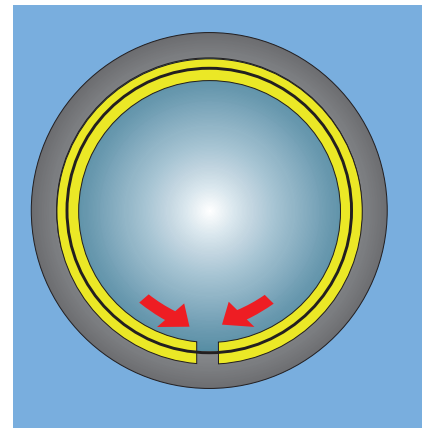
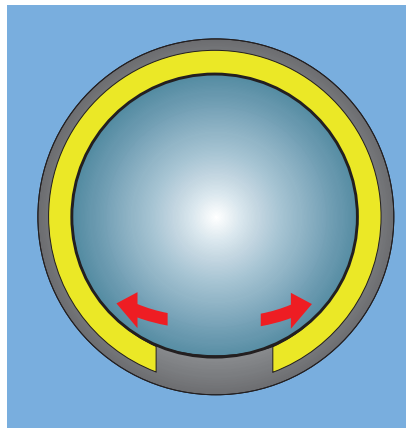

Lid open, circumferential locking ring in the ready position.

Lid closed, circumferential locking ring in lock position. The internal steam pressure presses the lip seal between lid and chamber.

## **DX** **DE** Automatic door-opening

In types DX and DE, the autoclave door functions automatically – either by pressing a button or automatically at the end of a program. A simple system but useful in practice. Residual steam is exhausted automatically without having to interrupt the process. Residual heat is used to dry the items being sterilized during the final short stage in the autoclave. Automatic door-opening is restricted to approx. 15° to avoid possible contamination from the outside. This is especially important and facilitates the working process when items to be sterilized have to remain in the autoclave for cooling and drying. Subsequently, for removing the sterilized items, the door can be completely opened manually.

## Novel automatic lid-opening system

Easy but safe – on closing, the lid is automatically locked by a circumferential ring system. A special lip seal made of heat-resistant silicone provides reliable tightness; the more the steam pressure increases, the tighter the seal becomes – without the need for additional compressed air or other media!

The lid is unlocked either by pressing a button or automatically at the end of a program. The door-locking system is temperature dependent – according to national and international standards. Also, the door remains locked as long as there is excess pressure in the chamber.

The lid, like other parts of the pressure vessel and housing, is made of stainless steel. The attractively designed front covers are made of heat-resistant, insulating plastic. There is thus no risk of the operator coming into contact with hot components of the system.

## **DX** **DE** Pressure-safe up to 5 bar/150 °C.

Tomorrow's requirements are catered for in today's design! The Systec D-Series autoclaves are the first of their kind to be designed for higher pressures and temperatures. The standard pressure chamber is designed to cope with 5 bar/150 °C. If the expanded pressure and temperature model is selected as an option, all control and safety components are adapted to the higher temperature and pressure. This option may be fitted retrospectively.

Systec D-Series autoclaves are equipped ex-factory for sterilization temperatures up to 140 °C and a pressure of 4 bar. Systec D-23 standard temperature and pressure range 136 °C / 3.8 bar.

The extension of pressure and temperature to 5 bar / 150 °C is not available for Systec D-23 and Systec D-45.



## New generation – with microprocessor and software!

Pressure and temperature regulation is via an electronic pressure sensor in the sterilization chamber or a flexible temperature sensor in a reference vessel (for liquids). A microprocessor specially developed for our autoclaves regulates and controls all relevant systems. In addition to vapor pressure, temperature and sterilization time all options such as rapid cooling, pre- and post-vacuums and drying are included.



### **DX** Available programs\*

- 1-3 Solids
- 4-5 Waste bags
- 6 Liquid waste with regulated steam exhaust for cooling
- 7 Liquid waste for self-cooling
- 8-10 Liquids with regulated steam exhaust for cooling
- 11 Liquids for self-cooling
- 12 Cleaning
- 13 Vacuum test\*\*
- 14 Bowie-Dick Test\*\*
- 15-25 Free for individual programming

\*\*Only in combination with a vacuum device

### **DE** Available programs\*

- 1-3 Solids
- 4-5 Waste bags
- 6 Liquid waste with regulated steam exhaust for cooling
- 7 Liquid waste for self-cooling
- 8-10 Liquids with regulated steam exhaust for cooling
- 11 Liquids for self-cooling
- 12 Cleaning

### **DB** Available programs\*

- 1 Solids
- 2 Waste bags
- 3 Liquid waste with regulated steam exhaust for cooling

\* All programs can be individually parametered

## Menu-presented instructions in text form

These can be selected from German, English, French, Spanish and Italian. Other languages are available as options. Large, easy-to-read display. Membrane keyboard with acoustic confirmation signal. Ergonomically located – everything is logical and easy to operate.

## Immediate documentation

Optional, with integrated printer for program type, batch number, date, time, temperature, pressure and sterilization phase.

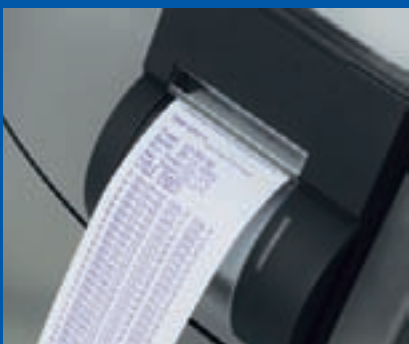

## **DX** **DE** Documentation, dialog and diagnosis via PC

Includes a standard RS 232 and RS 485 interface for direct connection to a PC. Special software for use with Windows optional. Suitable for documentation of all process data including relevant diagrams. In addition, dialog for adapting programs, changing parameters, calibrating and adjusting. Distant diagnosis via modem is also possible.

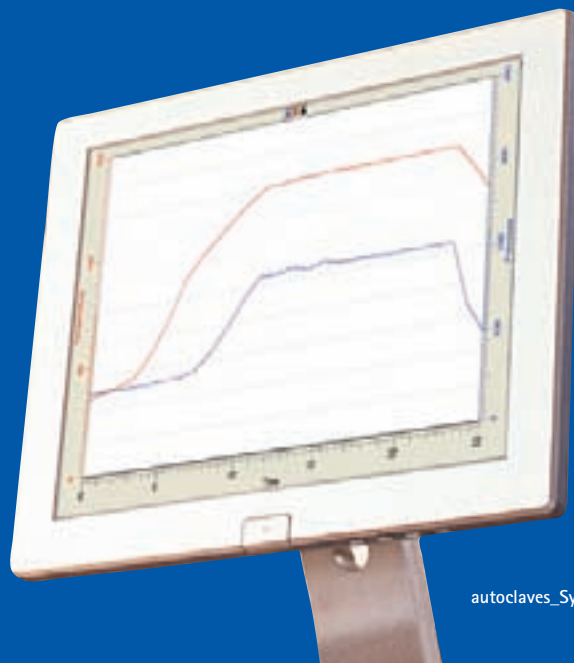

# Design – pure innovation!

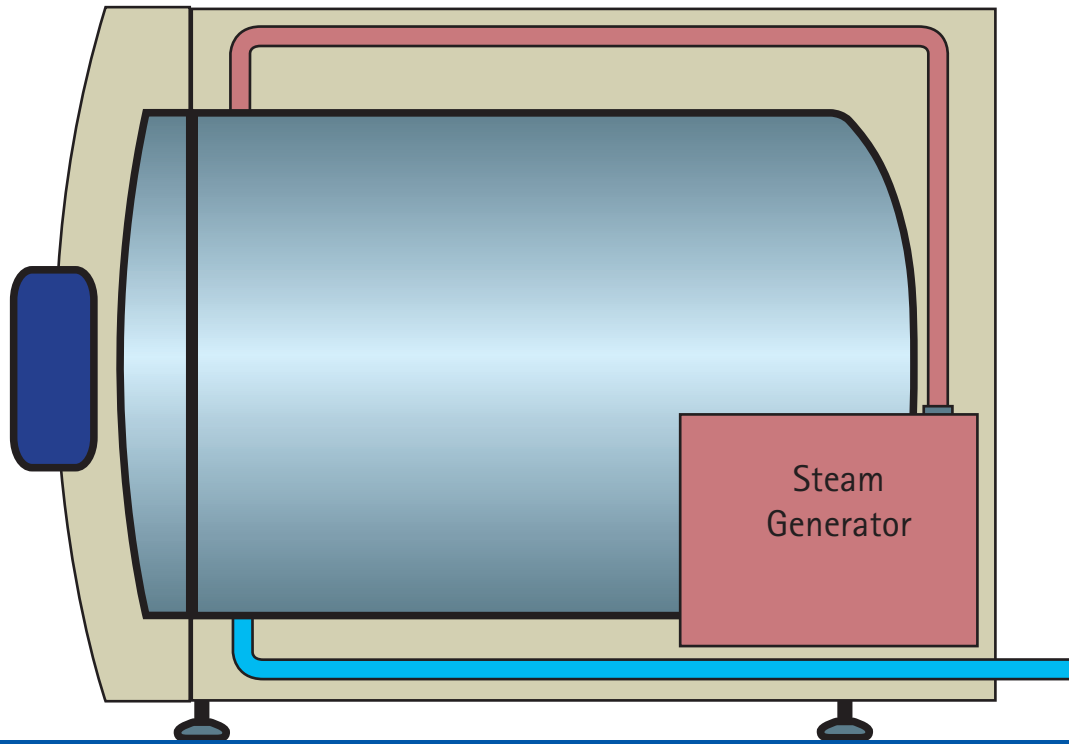

## **DX** Steam generation!

A separate steam generator is incorporated in the housing.

This has substantial advantages:

- No heating elements and no reservoir for dirty water in the chamber
- In conjunction with the stand-by pre-heating option, only 10 min. heating time to 121 °C with an empty chamber
- Improved removal of air from the empty chamber via pulsed heating (rapid attainment of optimal steam atmosphere)
- Accuracy better than  $\pm 0.3$  K with empty chamber
- Quicker cooling as neither hot water in the chamber nor the separate steam generator need be cooled
- On cooling, steam is immediately available for the next sterilization run.

## **DX** **DE** Condensation instead of steam removal!

Exhaust steam is condensed automatically via a PT 100-regulated cooling system. This prevents odors and protects waste water piping that may be made of plastic.

### Systemc D-23 and D-45 With feed water reservoir!

This makes both autoclaves mobile and flexible. As there is no need for a fixed water connection, they can be used in different rooms at different times. They can be allocated directly to a particular working area according to the task on hand.



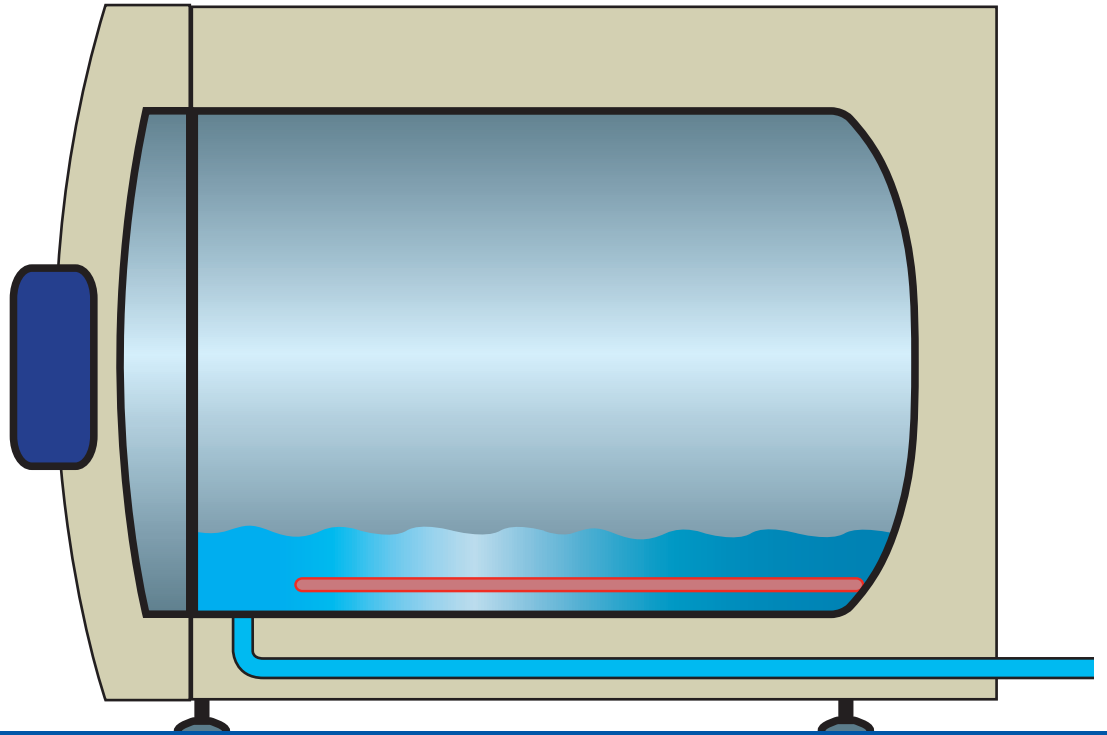

**DE** **DB** Conventional steam generation.

In this system, powerful heating elements are integrated directly on the floor of the sterilization chamber. As required, deionized water can be fed in, heated and converted to steam. The deionized water for steam generation can be fed in manually, and for DE-series also automatically with demineralised water connection.



## Innovative design – to the last detail!



### Guaranteed sterilization of liquids

During the entire sterilization process the temperature is measured by a PT 100 flexible temperature sensor in a reference vessel. In this way it is guaranteed that the sterilization process begins only when the sterilization temperature of the liquid has been attained. The cooling temperature is also continuously monitored. As required by the operating standards and to prevent delayed boiling, the door can only be opened when the temperature of the liquid has cooled to at least 80 °C.





## High, all-round quality!

The pressure vessel is made of corrosion-resistant electro-polished stainless steel 1.4571 (V4A) AISI 316 Ti and is thus easy to clean. The excess pressure release safety valve is of the approved component type. Autoclave framework and housing are also made of stainless steel. The highly efficient, high-quality Hanno-Tect insulation material releases no particles; thus, the Systec D-Series can be used under clean room conditions.



Compressed air connection (optional)

Demineralized water feed for steam generation

Cooling water feed

Collection outlet (drain)

Interface RS 232/485

Flexible power connection with CEE plug

# Intelligent process engineering for quicker and safer processes!

The actual sterilization time of e.g. 15 – 20 minutes at 121 °C is only a fraction of the total time required for the entire sterilization process. Especially when sterilizing liquids, the heating up and cooling down times are far longer (fig. 1).

## The conventional process.

In conventional systems, the set sterilization temperature may in fact be reached within the autoclave; however, the liquids to be sterilized may only have reached approx. 100 °C. The temperature equilibrium time between chamber and liquid temperature is usually much longer.

The cooling process for liquids is also very slow as the heat under 100 °C can only be dispersed by convection via the chamber insulation if there is no rapid cooling facility.

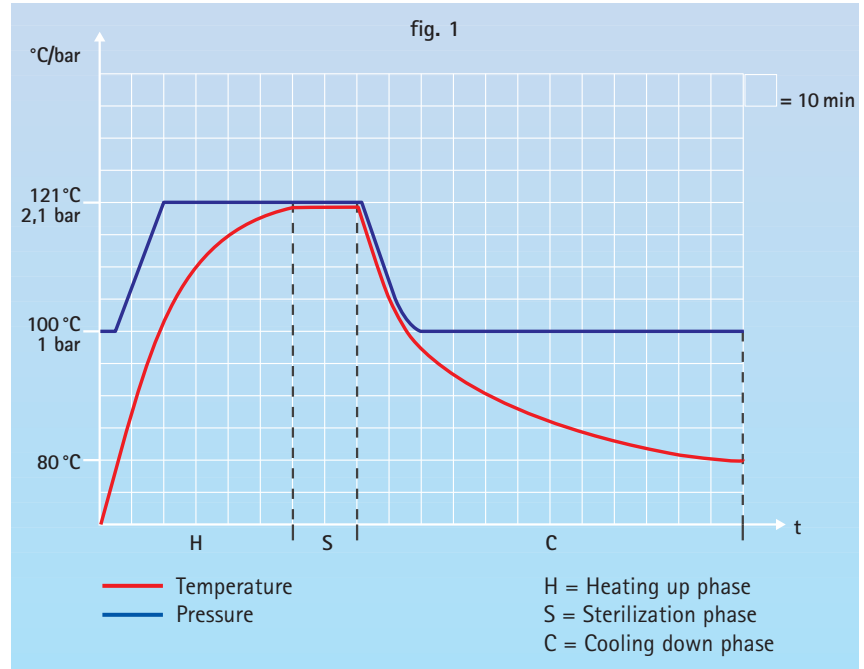

\* The times indicated in the diagram are dependent on the size and number of items to be sterilized.



# Time saving through new process technology.

New system and process technology have made it possible to shorten the entire process considerably. Several hours can be saved in this way! In addition, the media need not be exposed to temperatures unnecessarily (fig. 2).

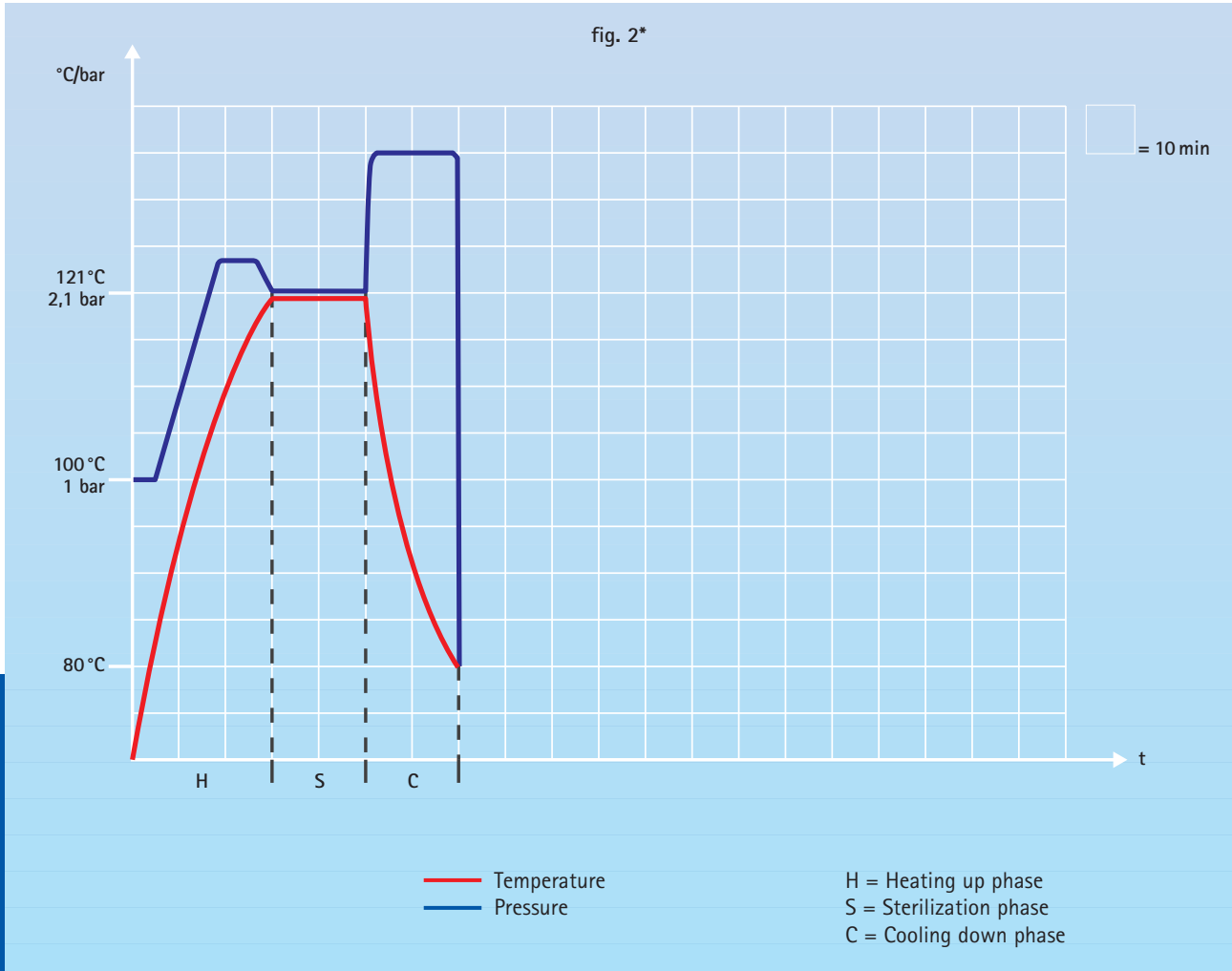

Up to 50 % shorter heat-up times possible as standard!

**DX** **DE** Up to 90 % shorter cooling times!

Due to the combined temperature and pressure regulation, the chamber pressure is increased during the heat-up phase. The result: more rapid temperature equilibrium in the liquids and a shorter heat-up time.

Various optional rapid cooling systems enable the cooling times for liquids to be significantly reduced. This conserves nutrient media and makes for efficient utilization of the autoclave.

\* The times indicated in the diagram are dependent on the size and number of items to be sterilized.

# Options: prepared for special applications!

## DX SuperDry

For the efficient drying of solids, hollow items and porous items such as filters and textiles. In this case, the series-installed steam generator supplies the heat for drying. Rapid surface drying with open lid or penetrating vacuum drying in combination with the optional vacuum facility are possible. Subsequent drying in a separate drying cabinet is thus unnecessary!

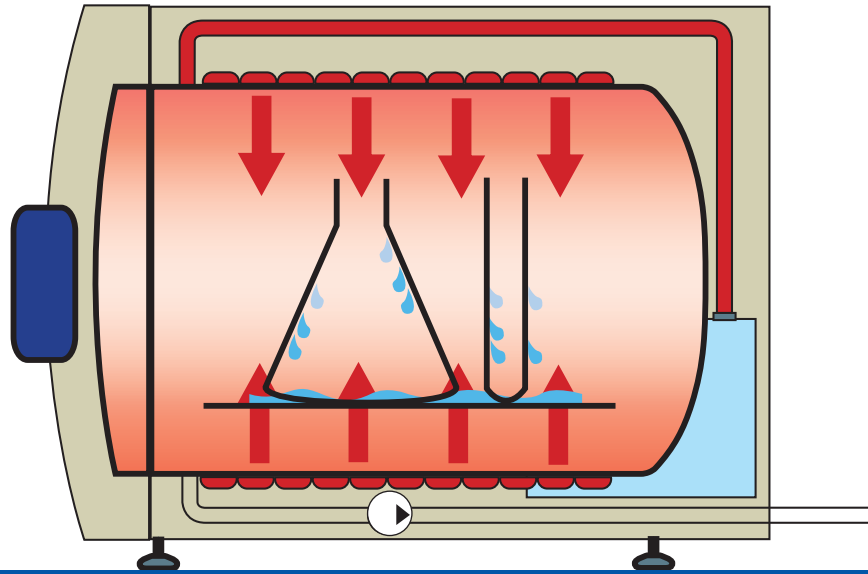

## Magnetic stirrer

For the homogeneous mixing of liquids during the sterilization processes. Can be placed directly in the chamber as required and is provided with power via a flexible cable through the validation port.



## DX DE Exhaust air filtration and sterilization of condensate

When working with infectious material, the exhaust air is filtered via an autoclavable sterile filter comprising a filter cartridge with PTFE membrane, pore size 0.2 µm, incorporated in a pressure-resistant housing and easily replaced. The filter is automatically sterilized during each sterilization process, monitored by a PT 100 temperature sensor. The condensate is retained during the heating and sterilization phases and thus also sterilized. In this way, neither aerosole particles nor microorganisms can escape before the sterilization process is completed.



## DX Vacuum facility

For the highly effective ventilation of hollow items, tubes, porous material, textiles and destruction bags, where the steam is able to fully penetrate the items to be sterilized. The facility enables a straight-forward vacuum or – in combination with the series-installed steam generator – a fractionated pre-vacuum (several sequential vacuum/pressure cycles) to be used. Only thus a validatable sterilization of porous materials, hollow items, textiles and waste bags can be obtained, even with high contamination.





**DX DE** Radial ventilator

Together with the optional cooling system, the ventilator ensures accelerated removal of heat, through air circulation, from the sterilization load to the cooled mantle.

The fan is located in the convex lid (hence no reduction of chamber depth!) and is driven via a magnetic clutch by a motor fitted under the lid cover.



**DX DE** Up to 90% quicker cooling!

Systec autoclaves are equipped with classical cooling systems (regulated steam exhaust down to 100 °C) and subsequent extremely slow self-cooling to min. 80 °C; however, optional systems for rapid cooling are available:

- Mantle cooling with cooling water
- Mantle cooling with cooling water and support pressure

- Mantle cooling with cooling water recirculated through a heat exchanger
- Radial ventilator for air circulation and accelerated heat removal in the chamber
- Spray cooling with recirculated and recooled sterile water and support pressure
- Cooling with ambient air ventilation

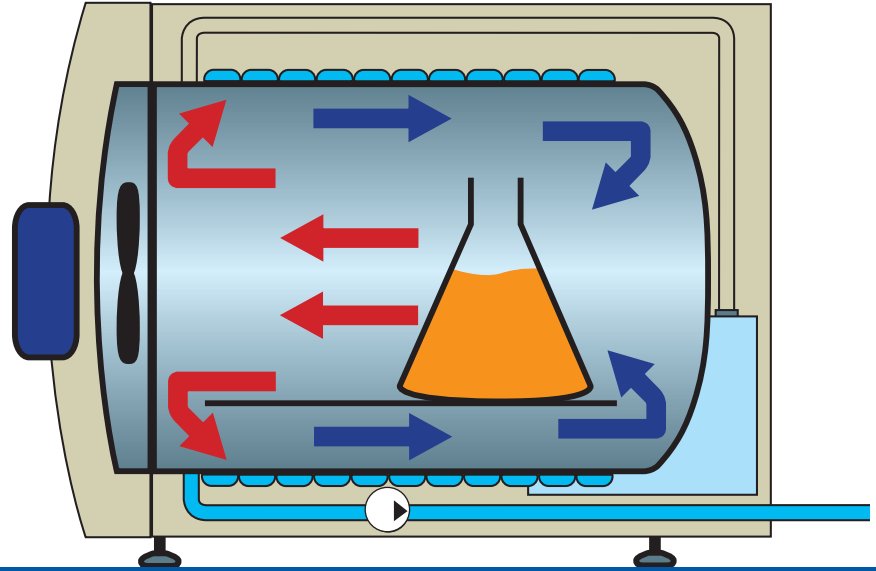

**Important notice for effective sterilization!**

As already described, several options are available should it be necessary to obtain correct and validatable results or rapid cooling times, especially in the case of liquids. The options that can be used depend on the type of items to be sterilized. It is thus important for you to think carefully about your requirements so that the autoclave can be optimally configured

for the tasks on hand. A validatable sterilization process with confirmable biological efficiency can only be obtained if the instrument configuration has been correctly thought out. The table below provides help in establishing the desired configuration; however, we recommend obtaining additional advice from our experts.

**Optional: technology for special applications**

For the sterilization of liquids in closed vessels, plastic bottles, bags, cans, blisters or food packs, e.g.:

- System and program for sterilization in a mixture of steam and air
- System and program for sterilization with hot water spraying and spray cooling

**The right process for your sterilization application:**

Procedure/ Process:	Air release				Cooling		Drying		Other
	Gravitation	Single pre-vacuum	Pulsed heat up (over pressure pulses)	Fractionated pre-vacuum	Conventional cooling with slow steam release	Rapid cooling system with support pressure	Surface drying without vacuum (+SuperDry)	Drying with subsequent vacuum (+SuperDry)	Exhaust air filtration
Liquids	+	?	-	-	?	+	-	-	
Unpacked non hollow items	+	+	+	+			?	+	
Porous materials (filters, textiles)	-	?	?	+			-	+	
Hollow items (pipette tips, empty glassware, tubes and hoses)	-	-	-	+			-	+	
Contaminated waste in "destruction bags"	-	-	?	+			-	-	+

+ recommended procedure    ? eventually acceptable    - not possible

## System accessories for ease of handling!



### Support Tables

There is a special table for each of the Systec D-Series autoclaves. These are custom-dimensioned for the instrument in question. The tables are 72 cm high (other heights available at no extra charge) and make for ease of handling. They have a practical shelf e.g. for storing baskets etc.

### Loading trolley

Large autoclaves in particular can be easily and securely filled using a special loading trolley. The items to be sterilized can either be placed on the sliding platform of the trolley or in a filling basket. The trolley can now be moved to the autoclave and fixed in position by a clamp. The clamp can then be loosened to allow the platform to slide into the autoclave on fixed rails.

### Stainless steel quality!

All parts are made of stainless steel and cleanly welded. Bench-top autoclaves are fitted with adjustable leveling screws to ensure stability; the filling trolleys have large rollers, two of them fitted with brakes, to ensure smooth running.



### Loading shelves

To fully utilize the available space in the chamber, especially when sterilizing small items, every autoclave can be fitted with a set of loading shelves. The entire shelving system or individual trays can be removed.



## Loading baskets and inserts

### Wire mesh baskets out of stainless steel, stackable

Art. No.	Inner Dimensions L x W x H (mm)	Hold capacity per autoclave						
		D-23	D-45	D-65	D-90 DX-90 2D	D-100	D-150 DX-150 2D	D-200 DX-200 2D
1552	390 x 168 x 132	1						
1553	490 x 265 x 180		1					
4072	490 x 310 x 210			1				
5074	688 x 310 x 210				1			
6071	490 x 360 x 290					1		2
6072	490 x 360 x 140					2		4
7071	355 x 360 x 290						2	
7072	735 x 360 x 290						1	
7075	355 x 360 x 140						4	
7076	735 x 360 x 140						2	

### Closed tubs out of stainless steel for waste sterilization

Art. No.	Inner Dimensions L x W x H (mm)	Hold capacity per autoclave						
		D-23	D-45	D-65	D-90 DX-90 2D	D-100	D-150 DX-150 2D	D-200 DX-200 2D
1554	395 x 180 x 135	1						
1555	495 x 265 x 180		1					
4073	495 x 318 x 219			1				
5075	696 x 318 x 219				1			
6070	495 x 368 x 300					1		2
7070	368 x 368 x 300						2	
7073	747 x 368 x 300						1	



## Our Quality Assurance

Each and every component used is subjected to stringent controls and each autoclave is thoroughly checked for function before being delivered. An acceptance protocol is issued.



### Step-by-step documentation optionally available!

Our Quality Management fulfills the highest requirements with regard to testing and documentation. Within the scope of our service, we also provide qualification and validation work with GMP-compliant documentation, e.g.:

- DQ Design Qualification
- IQ Installation Qualification
- OQ Operation Qualification
- PQ Performance Qualification

# Performance and competence!

## Performance and competence!

We only make one thing: laboratory autoclaves.  
But we do this exceptionally well!

Our goal is always to make laboratory work safer, easier, more accurate and more economical. With over 25 years of experience and constant cooperation with experts in practice, we know how to tackle and provide optimal solutions for even the most complex of sterilization tasks.

We have the knowledge and know-how to produce the results!

Our expertise and know-how are available for you worldwide through specialized partners.

## Product expertise:

- Development
- Design
- Production of series products
- Production of specialty products
- Application and technical advice

## Additional services:

- Installation and start-up
- Special technical developments
- Tests and process development
- Individual service on-call
- Contract service
- Qualification and validation
- GMP-compliant documentation

Rights reserved to change technical aspects as required.

# Systemec

t h e a u t o c l a v e c o m p a n y

Systemec GmbH  
Labor-Systemtechnik  
Sandusweg 11  
D-35435 Wettenberg  
Tel. +49 (0) 641-98211-0  
Fax +49 (0) 641-98211-21  
E-Mail: [info@systemec-lab.com](mailto:info@systemec-lab.com)  
Internet: [www.systemec-lab.com](http://www.systemec-lab.com)

Subsidiary Switzerland:  
Systemec Schweiz GmbH  
Bösch 23  
CH-6331 Hünenberg  
Tel. +41 (0) 41 781 52 80  
Fax +41 (0) 41 781 52 79  
E-Mail: [info@systemec-lab.ch](mailto:info@systemec-lab.ch)  
Internet: [www.systemec-lab.ch](http://www.systemec-lab.ch)