

IKA

designed for scientists

IKA ICC basic



Operating instructions

EN

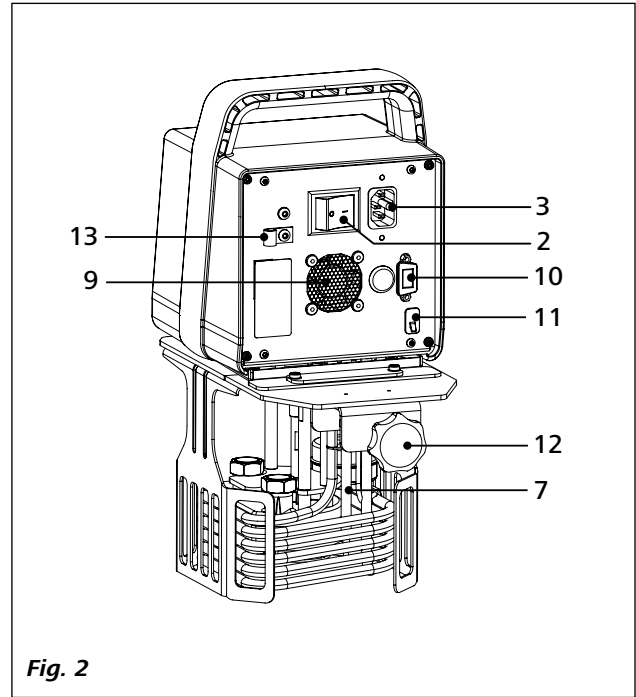
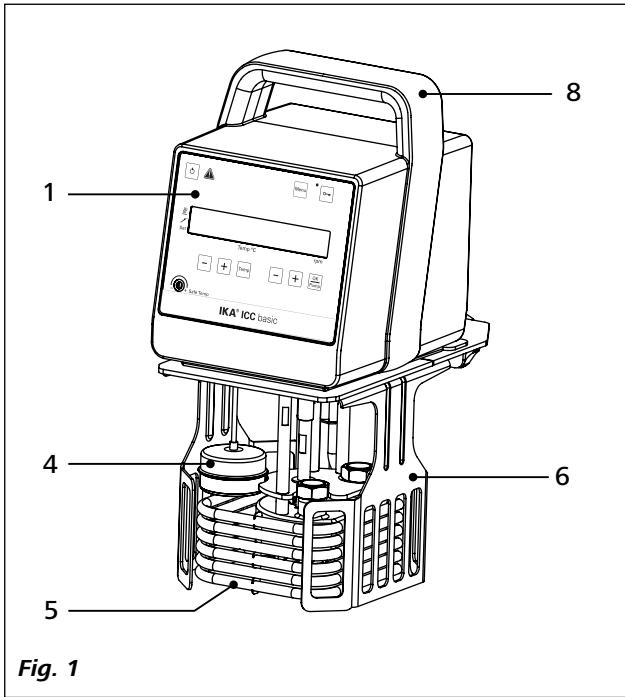

Item	Designation
1	Operator panel and display
2	Mains switch
3	Power socket
4	Buoyage
5	Heater
6	Stand
7	Pt 100 + Pt 1000 temperature sensor
8	Handle
9	Fan
10	RS 232 port
11	USB port
12	Clamp
13	Cable clip

Contents

	Page
EU Declaration of Conformity	4
Explication of warning symbols	4
Safety instructions	5
General information	5
Fluids	6
Intended use	7
Use	7
Range of use.....	7
Unpacking	7
Unpacking	7
Delivery scope.....	7
Useful information	7
Preparations	7
Setting up	7
Filling and draining.....	7
Fluids (Standard information for IKA fluid)	8
Operator panel and display	9
Commissioning	10
Setting the safety temperature	10
Menu settings	11
Menu structure	11
Basic guide to setting the menu options.....	11
Operating mode (MODE).....	11
Maximum temperature (HI T)	11
Minimum temperature (LO T)	11
Maximum speed (HI R)	11
Minimum speed (LO R).....	11
Fluid type (FLUI)	11
The type of temperature PID control arithmetic (AUTO)	11
Alarm and key tone (BEEP)	12
Calibration (CALI)	12
Interface and output	13
Maintenance and cleaning	15
Error codes	15
Accessories	16
Technical data	17
Warranty	18
Pump performance curve	18

EU Declaration of Conformity

We declare under our sole responsibility that this product corresponds to the directives 2014/35/EU, 2006/42/EC, 2014/30/EU and 2011/65/EU and conforms with the following standards or normative documents: EN 61010-1, EN 61010-2-010, EN 61326-1, EN 60529, DIN 12876-1 und EN ISO 12100.

A copy of the complete EU Declaration of conformity can be requested at sales@ika.com.

Explication of warning symbols



Indicates an (extremely) hazardous situation, which, if not avoided, will result in death, serious injury.



Indicates a hazardous situation, which, if not avoided, can result in death, serious injury.



Indicates a potentially hazardous situation, which, if not avoided, can result in injury.



Indicates practices which, if not avoided, can result in equipment damage.



Indicates a hazardous situation that cause from a hot surface!



Hot surface!

Safety instructions

General information:

- **Read the operating instructions completely before starting up and follow the safety instructions.**
- Keep the operating instructions in a place where it can be accessed by everyone.
- Ensure that only trained staff work with the device.
- Follow the safety instructions, guidelines, occupational health, safety and accident prevention regulations.
- Set up the device in a spacious area on an even, stable, clean, non-slip, dry and fireproof surface.
- Do not operate the device in explosive atmospheres, with hazardous substances.
- Protect the device and accessories from bumping and impacting.
- Check the device and accessories for damage before each use. Do not use damaged components.
- Safe operation is only guaranteed with the accessories described in the "**Accessories**" section.
- The socket for the mains cord must be easily accessible.
- Socket must be earthed (protective ground contact).
- The voltage stated on the type plate must correspond to the mains voltage.
- The device can only be disconnected from the mains supply by pulling out the mains plug or the connector plug.
- Disconnect the mains plug before attaching or changing any accessories.
- Disconnect the mains plug before cleaning, maintenance and transportation of the unit.
- The device must only be opened by trained specialists, even during repair. The device must be unplugged from the power supply before opening. Live parts inside the device may still be live for some time after unplugging from the power supply.

NOTICE

Coverings or parts that can be removed from the device without the aid of any tools must be put back on the device again to ensure safe operation, for example to keep foreign objects and liquids, etc. from getting into the device.

- The device may only be used as prescribed and as described in the operating instructions. This includes operation by instructed specialist personnel.
- When using critical or hazardous materials in your processes, **IKA** recommends to use additional appropriate measures to ensure safety in the experiment. For example, users can implement measures that inhibit fire or explosions or comprehensive monitoring equipment.
- Process pathogenic material only in closed vessels under a suitable fume hood. Please contact **IKA** application support if you have any question.

WARNING

If the **OFF** switch is not within reach when device is operating, an **EMERGENCY STOP** switch that can be easily accessed must be installed in the work area.

- A laboratory circulator heats and circulates fluid according to specified parameters. This involves hazards due to high temperatures, fire and general hazards due to the device of electrical energy. The user is largely protected by the device of relevant standards. Further hazard sources may arise due to the type of tempering fluid, e.g. by exceeding or undercutting certain temperature thresholds or by the breakage of the container and reaction with the heat carrier fluid. It is not possible to consider all eventualities. They remain largely subject to the judgment and responsibility of the operator. For this reason, it may become necessary for user to take other precautionary safety measures.
- Insufficient ventilation may result in the formation of explosive mixtures. Only use the device in well ventilated areas.

WARNING

The safety circuit (safe temperature) must be adjusted so that the maximum permissible temperature cannot be exceeded even in the event of a fault. Check the safe temperature circuit on a regular basis (see section "**Setting the safety temperature**").

- Securely fix the **ICC** immersion circulator for use at the bath, so that it cannot tip over.
- When device is used for external circulation, extra precaution must be taken for hot fluid leakage due to damaged hose.
- Use suitable hoses for connection.
- Secure hoses and tubes against slippage and avoid kinks.
- Check hoses, tubes and bath at regular intervals for possible material fatigue (cracks/leaks).
- Mains cable should not get in contact with hot parts and fluids.
- If you are using plastic bath, observe the permitted working temperature range and fluids.

DANGER

Do not start up the device if:

- It is damaged or leaking
 - Cable (not only supply cable) is damaged.
- Be careful when filling a hot bath.

WARNING

At high operating temperatures, the temperature of housing parts, surfaces and tubes can exceed 70 ° C.



WARNING

It is dangerous to touch the heater. The temperature of the heater can be very high.

- After a power failure during operation, the device may start automatically (depending on operating mode).
- Transport the device with care.
- Do not transport or empty the bath while it is still hot. This may result in accidents, especially scalding injuries.



NOTICE

In order to prevent the power cable from falling into the fluid, the mains cable must be secured with the cable clamp (13, see Fig. 2 and Fig. 4).

Fluids:



WARNING

Beware of the risk of burning due to delay in boiling!



WARNING

Only use fluids, which fulfill the requirements for safety, health and device compatibility. Be aware of the chemical hazards that may be associated with the bath fluid used. Observe all safety warnings for the fluids.

- Depending on the bath fluid used and the type of operation, toxic or flammable vapors can arise. Ensure suitable extraction.
- Do not use any fluid which may cause dangerous reactions during processing.
- Only use recommended bath fluid. Only use non-acid and non corroding fluid.



WARNING

Only process and heat up any fluid that has a flash point higher than the adjusted safe temperature limit that has been set. The safe temperature limit must always be set to at least 25 °C lower than the flash point of the fluid used. Examine regularly the function of the safety temperature limiter.



NOTICE

Never operate the device without sufficient heat carrier fluid! You should also be careful to ensure that the minimum clearances and immersion depths in the fluid are observed. Check the fluid level detection at a regular basis (see section "Filling and draining").

- Continuous monitoring of the bath and the filling level of the bath fluid is required, especially at high temperatures.
- For optimum temperature stability, the fluids viscosity should be 50 mm²/s or less at its lowest operating temperature. This permits good fluid circulation and minimizes heating from the pump.



NOTICE

If water is used at higher temperature, there is heavy loss of fluid due to the evaporation.

- Untreated tap water is not recommended. It is recommended to use distilled water or high purity water (ion exchangers) and add 0.1 g soda (sodium carbonate Na₂CO₃) /liter, to reduce corrosive properties.



WARNING

Risk of burning caused by vapor or hot water at the outlet of the cooling coil (accessory).



NOTICE

Do not use the cooling coil with water at bath temperatures > 95° C.



NOTICE

For bath temperatures > 60°C make sure that the flow rate through the cooling coil is high enough.



NOTICE

Don't use following fluids:

- Untreated tap water
- Acids or bases
- Solutions with halides: chlorides, fluorides, bromides, iodides or sulfur
- Bleach (Sodium Hypochlorite)
- Solution with chromates or chromium salts
- Glycerine
- Ferrous water.



NOTICE

When changing the bath fluid from water to a heat transfer fluid for temperatures above 100 °C, remove the remaining water from the complete system (including hoses and external devices). When doing this, also open the stopper and union nuts caps of the pump outputs and inputs and blow compressed air through all the pump outputs and inputs!

Intended use

Use:

Use **ICC** (Immersion Circulator Compact) for heating and circulating fluids.

Intended Use: Tabletop device

Range of use:

Indoor environments similar to that a laboratory of research, teaching, trade or industry.

The safety of the user cannot be guaranteed:

- If the device is operated with accessories that are not supplied or recommended by the **IKA**.
- If the device is operated improperly or in contrary to the **IKA** specifications.
- If the device or the printed circuit board are modified by third parties.

Unpacking

Unpacking:

- Please unpack the device carefully
- In the case of any damage a detailed report must be sent immediately (post, rail or forwarder).



NOTICE

Transport safety

Remove the transport protection under the buoyage (4).

Delivery scope:

- **ICC baisc**
- Mains cables
- USB 2.0 cable (A–micro B)
- Screwdriver (use for safety circuit)
- User guide
- Warranty card.

Useful information

When you operate the device in water bath with temperature higher than 60°C do not switch off the device before the temperature is below 60°C. Water steam could enter into the housing and cause damage.

Starting from software version 1.30 a function is included which will let run the internal fan to avoid this effect even if the device is switched to standby mode (by pressing the On/Off button **(A)**).

Do not disconnect the power cord or switch the device off by pressing the power switch **(2)**. Alternatively remove the ICC device out of the bath.

Update the firmware to enable this feature (see section "Interface and output").

Note: with an older software version let the pump run until the water temperature is below 60°C.

Preparations

Setting up:

- Securely fix the immersion circulator on the bath.
- Place the device on an even, stable, clean, nonslip, dry and fireproof surface.
- Keep at least 20 cm of open space at the front and rear side.
- When a plastic bath is used, please ensure that the heater does not contact the bath.
- The place for installation should be large enough and provide sufficient air ventilation to ensure the room does not warm up excessively because of the heat from device radiates to the environment.
- Do not set up the device in the immediate vicinity of heat sources and do not expose to sun light.

Filling and draining:

- Connect the mains plug and turn on the device with mains switch **(2)**.
- The low level warning message appear on the display.
- Fill fluid to the bath.

Note: Pay attention to the fluid level information on the display:



Low Level



High Level

For draining, please refer to the bath operating instructions.

Fluids (Standard information for IKA fluid):

No.	IKA Designation	Operating temperature range for open bath application (°C)	Operating temperature range for closed bath applications (°C)	Safety temperature (°C)	Flash point (°C)
0	CF.EG28.N10.80.8	-10 ... 80	-10 ... 80	90	115
1	CF.EG39.N20.80.16	-20 ... 80	-20 ... 80	90	115
2	CF.EG44.N25.80.19	-25 ... 80	-25 ... 80	90	115
3	CF.EG48.N30.80.22	-30 ... 80	-30 ... 80	90	115
4	UF.Si.N30.150.10LV	-30 ... 130	-30 ... 150	145 ❶	>170
5	HF.Si.20.200.50	20 ... 200	20 ... 200	255	>280
6	HF.Si.20.250.50A	20 ... 200	20 ... 250	255	>280
7	Water ❷	5 ... 95	5 ... 95	-	-
8	Customized ❸				

Check the suitability of the fluid according to your application.

Nomenclature for **IKA** fluids:

CF.EG28.N10.80.8 --

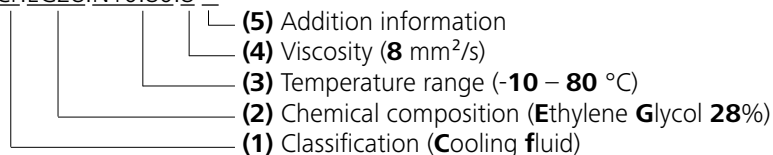
**(1) Classification:**

HF: Heating Fluid
CF: Cooling Fluid
UF: Universal Fluid

(2) Chemical composition:

Si: Silicone oil
EG: Ethylene Glycol

(3) Temperature range: (Minimum temperature. Maximum temperature)

N: Negative Temperature

(4) Viscosity:

Viscosity at 25 °C for **Heating Fluid (HF)**
 Viscosity at -20 °C for **Cooling Fluid (CF)**
 Viscosity at 25 °C for **Universal Fluid (UF)**

Dynamic viscosity [mPa.s] is a product of kinematic viscosity [mm²/s] and density [kg/m³] of the fluid divided by 1000.

(5) Additional information:

A: Oil Additives
LV: Low Viscosity

❶ **Note:** For open bath application!

❷ **Note:** Tap water may be unsuitable for operation because the calcium carbonate content may cause calcification.

High purity water (from ion exchangers) and distilled or bi-distilled water are unsuitable for operation due to corrosive properties of these media. High purity water and distillates are suitable as a medium after adding 0.1 g soda (Na₂CO₃, sodium carbonate) per liter of water.

❸ **Note:** The temperature limit values are adjustable in accordance with the fluid used.

Operator panel and display

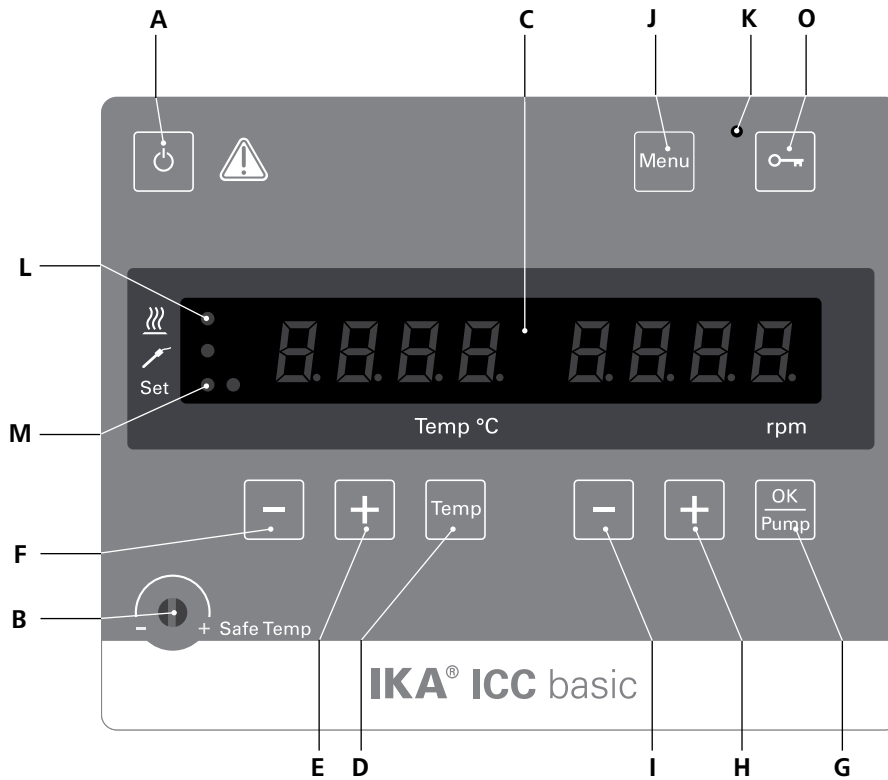
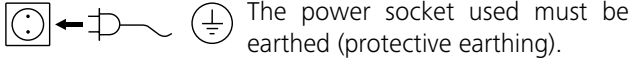

Fig. 3

Item	Designation	Function
A	On/Off button:	Switch on/off the circulator.
B	Adjustable safety circuit:	Adjust the safety temperature limit with delivered screwdriver.
C	LED display:	Display the settings and actual values.
D	"Temp" button:	Start/stop the heating function.
E	"Temp (+)" button:	Increase the temperature setting value.
F	"Temp (-)" button:	Decrease the temperature setting value.
G	"OK/Pump" button:	Start/stop the pump function.
H	"Pump (+)" button:	Increase the pump speed setting value.
I	"Pump (-)" button:	Decrease the pump speed setting value.
J	"Menu" button:	Press it once: menu option is display. Press it a second time: back to the working screen.
K	LED, key button:	Indicate that the function of keys are deactivated.
L	LED, heater:	Indicate the heating function is activated.
M	LED, set:	The LED lights up at the same time as the set value is displayed.
O	Key button:	Lock/unlock keys.

Commissioning

Check whether the voltage specified on the type plate matches the mains voltage available.



The power socket used must be earthed (protective earthing).

If above conditions are met, the device is ready for operation after plugging in the mains plug.

If these conditions are not met, safe operation is not guaranteed and the device could be damaged.

Observe the ambient conditions (temperature, humidity, etc.) listed under “**Technical Data**”.

After switching on the mains switch (2) at the back of the device or pressing the power key (A), all LED segments light up during the self test.



①

Starting



②

Software version (ver)



③

Operating mode (mode)



④

Safety temperature (safe)



⑤

Working setting

After that, following two screens appear alternatively.



⑥



⑦

Then the device enters standby status and is ready for operation.

Change the temperature setting with “**Temp (+)**” button (E) or “**Temp (-)**” button (F).

Change the pump speed setting with “**Pump (+)**” button (H) or “**Pump (-)**” button (I).

In standby status, activate the heating function by pressing the “**Temp**” button (D). The device start heating function, meanwhile the pump start to run.

In working status, press the “**OK/Pump**” button (G) to stop the pump function. The heating function and pump stops.

Note: In running status, the pump speed adjusts automatically according to the load. When the actual speed doesn't reach the setting speed, the actual speed and setting speed will appear on the screen alternately.

In standby status, press the “**OK/Pump**” button (G) to start the pump function. The heating function will not be activated.

In working status, press the “**Temp**” button (D) to stop the heating function, the pump keep running.

The control elements of the device allow to be locked by pressing the key button (O), so no accidental changes during operation are possible (LED (K) lights up).

By pressing the key button (O) again, the controls are released (LED (K) no longer lights up).

Setting the safe temperature

Adjust the safe temperature with screwdriver delivered with the device.



Fig. 4

The safe temperature setting will appear on the display.



Safety temperature (safe)

Factory setting: approximate max. value

Adjustment range: 0 – 160 °C

Warning: The safe temperature must always be set to at least 25 °C lower than the flash point of the fluid used.

Menu settings

• **Menu structure:**

		Default settings
Menu	MODE	A ----- activated
		B ----- -
		C ----- -
	Maximum temperature (HI T) -----	150 °C
	Minimum temperature (LO T) -----	-20 °C
	Maximum speed (HI R) -----	3200 rpm
	Minimum speed (LO R) -----	1000 rpm
	Fluid type (FLUI) -----	8
	The type of temperature PID control arithmetic (AUTO)	AUTO 1 ----- activated
		AUTO 0 -----
		Proportional coefficient of PID (Kp 1) -- 15.0
		Integrate time of PID (Ti 1) ----- 5.00
		Differential time of PID (Td 1) ----- 5.0
	Alarm and key tone (BEEP)	BEEP 0 ----- -
		BEEP 1 ----- activated
Calibration (CALI)	CALI 0 ----- activated	
	CALI 2 ----- -	
	CALI 3 ----- -	

• **Basic guide to setting the menu options:**

- ☞ Enter the menu by pressing "Menu" button (J).
- ☞ Press the "Temp (+)" button (E) or "Temp (-)" button (F) to change the menu options.
- ☞ Press the "Pump (+)" button (H) or "Pump (-)" button (I) to change the value settings in the menu.
- ☞ Confirm the menu settings by pressing the "OK/Pump" button (G).

• **Operating mode (MODE):**



Mode A: After power on/power failure no automatic restart of functions.

Mode B: After power on/power failure automatic restart of functions, depending on previous settings.

Mode C: Set values (set in A or B) cannot be changed. After power on/power failure automatic restart of functions, depending on previous settings.

• **Maximum temperature (HI T):**



The maximum adjustable value: 150° C. This value can be limited additionally by the selected fluids (see section "Fluids").

Note: The maximum value is limited by the set safe temperature.

• **Minimum temperature (LO T):**



The minimum adjustable value: -20° C

• **Maximum speed (HI R):**



The maximum adjustable value: 3200 rpm.

• **Minimum speed (LO R):**



The minimum adjustable value: 1000 rpm

• **Fluid type (FLUI):**



The chosen fluid (No.) of the temperature setting is limited. See Section "Fluids".

• **Temperature control type (AUTO):**



AUTO 1:

AUTO 1 is the default setting. The optimum settings are determined automatically.

Heat-up curve in auto-tuning control (**AUTO 1**):

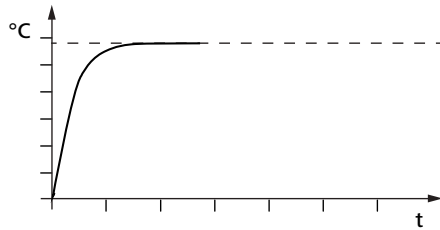

Fig. 5

AUTO 0:

For special requirements, **AUTO 0** can be used with manual adjustment of the control parameters.

If the PID control (**AUTO 0**) option is selected, the following items including **Kp 1**, **Ti 1** and **Td 1** could be set. Otherwise they are not displayed in the menu list.

Note: Inappropriate settings may produce the following heat-up curves:

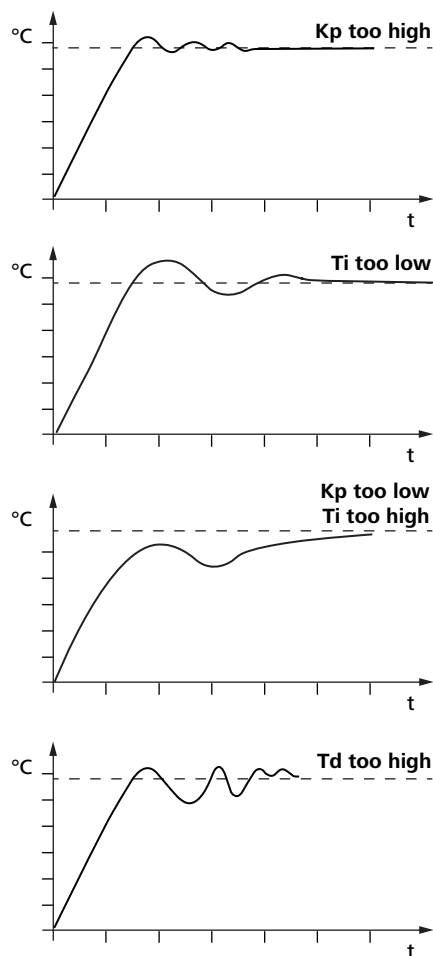

Fig. 6

Proportional coefficient of PID (**Kp 1**):



The proportional coefficient **Kp** is the controller amplification and determines how strongly the control deviation (the difference between the target temperature and actual temperature) directly affects the control variable (on-time of the heater). **Kp** values that are too large can lead to the controller overshooting.

Integral time of PID (**Ti 1**):



The integral time **Ti (s)** is the correction time and determines how strongly the duration of the control deviation affects the control variable. **Ti** compensates an existing control deviation. A high **Ti** means a smaller and slower effect on the control variable. **Ti** values that are too small can lead to instability of the controller.

Differential time of PID (**Td 1**):



The differential time **Td (s)** is the derivative time and determines how strongly the rate of change of the control deviation affects the control variable. **Td** compensates for rapid control deviations. A high **Td** means a smaller and slower effect on the control variable. **Td** values that are too small can lead to instability of the controller.

• Alarm and key tone (BEEP):



BEEP 0: no alarm and key tone

BEEP 1: alarm and key tone is activated

• Calibration and adjustment (CALI):



CALI 0: Reset calibration

CALI 2: 2-point calibration

CALI 3: 3-points calibration

Example: 2-point calibration:

Dip the temperature sensor of the reference measuring instrument into the bath fluid:

Select 2-point calibration in the menu. Press the "OK/Pump" button (**G**) to start the 2-point calibration.

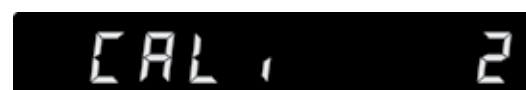

Set the first point temperature (e.g. 80 °C). Confirm the setting by pressing the “OK/Pump” button (G).



Left area of the display appears the set value (80 °C) and the right area of the display appears the actual temperature value measured. The set LED (M) flashes briefly.



The unit now starts and controls to the set value. When the temperature has reached the set value and has become constant, the “Set” LED (M) no longer flashes and the following display appears.

The temperature measured by the unit appears on the left hand side.

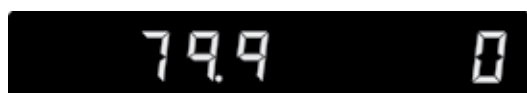

Input the calibration value from the reference measuring instrument (e.g. 80.2 °C) with the “Pump (+)” button (H) or “Pump (-)” button (I).

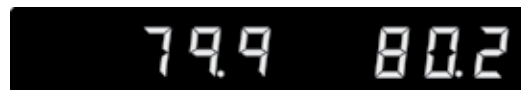

Confirm the value by pressing the “OK/Pump” button (G). Back to previous screen for input a new value by pressing the “Temp” button (D).

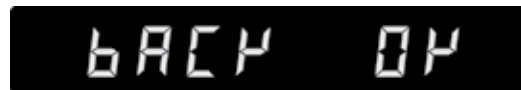

Back

OK

The first point calibration is finished now. Calibration of the other points is performed in the same way.

Interface and output

The device can be operated in “Remote” mode via the RS 232 interface (10) or the USB interface (11) connected to a PC and with the laboratory software Labworldsoft®. The device software can also be updated with a PC via the USB or RS 232 interface.

Note: Please comply with the system requirements together with the operating instructions and help section included with the software.

USB interface:

The Universal Serial Bus (USB) is a serial bus for connecting the device to the PC. Equipped with USB devices can be connected to a PC during operation (hot plugging). Connected devices and their properties are automatically recognized.

USB device drivers:

First, download the latest driver for IKA devices with USB interface from:

<http://www.ika.com/ika/lws/download/usb-driver.zip>.

Install the driver by running the setup file. Then connect the IKA device through the USB data cable to the PC.

The data communication is via a virtual COM port. Configuration, command syntax and commands of the virtual COM ports are as described in RS 232 interface.

Note: the USB driver is unnecessary for Windows 10 system. Don't install it for Windows 10 system!

RS 232 interface:

Configuration

- The functions of the interface connections between the device and the automation system are chosen from the signals specified in EIA standard RS 232 in accordance with DIN 66 020 Part 1.

- For the electrical characteristics of the interface and the allocation of signal status, standard RS 232 applies in accordance with DIN 66 259 Part 1.
- Transmission procedure: asynchronous character transmission in start-stop mode.
- Type of transmission: full duplex.
- Character format: character representation in accordance with data format in DIN 66 022 for start-stop mode. 1 start bit; 7 character bits; 1 parity bit (even); 1 stop bit.
- Transmission speed: 9600 bit/s.
- Data flow control: none
- Access procedure: data transfer from the device to the computer takes place only at the computer's request.

Command syntax and format:

The following applies to the command set:

- Commands are generally sent from the computer (Master) to the device (Slave).
- The device sends only at the computer's request. Even fault indications cannot be sent spontaneously from the device to the computer (automation system).
- Commands are transmitted in capital letters.
- Commands and parameters including successive parameters are separated by at least one space (Code: hex 0x20).
- Each individual command (incl. parameters and data) and each response are terminated with Blank CR LF (Code: hex 0x20 hex 0x0d hex 0x20 hex 0x0A) and have a maximum length of 80 characters.
- The decimal separator in a number is a dot (Code: hex 0x2E).

The above details correspond as far as possible to the recommendations of the NAMUR working party (NAMUR recommendations for the design of electrical plug connections for analogue and digital signal transmission on individual items of laboratory control equipment, rev. 1.1).

The NAMUR commands and the additional specific **IKA** commands serve only as low level commands for communication between the device and the PC. With a suitable terminal or communications programme these commands can be transmitted directly to the device. The **IKA** software package, Labworldsoft®, provides a convenient tool for controlling circulating equipment and collecting data under MS Windows, and includes graphical entry features, for pump motor speed ramps for example.

Commands:

Commands	Function
IN_PV_2	Read the internal actual temperature
IN_PV_3	Read the safety actual temperature
IN_PV_4	Read the pump actual speed
IN_SP_1	Read the internal setting temperature
IN_SP_3	Read the safety setting temperature
IN_SP_4	Read the pump setting speed
OUT_SP_1 xxx	Set the internal setting temperature XXX
OUT_SP_12@n	Set the WD safety temperature with echo of the set (defined) value.
OUT_SP_4 xxx	Set the pump speed XXX
OUT_SP_42@n	Set the WD-safety speed with echo of the set (defined) value.
OUT_WD1@n	Start the watchdog mode 1 and set the time for the watchdog to n (20...1500) seconds. Echo of the Watchdog time. During a WD1-event, the heating and pump functions are switched off. This command needs to be send within the watchdog time.
OUT_WD2@n	Start the watchdog mode 2 and set the watchdog time to n (20...1500) seconds. Echo of the watchdog time. During a WD2-event, the set temperature is changed to the WD safety temperature and the pump set speed is set to the WD safety speed. This command needs to be send within the watchdog time.
RESET	Reset the PC control and stop the device functions.
START_1	Start the heating function
START_4	Start the pump function
STOP_1	Stop the heating function
STOP_4	Stop the pump function

PC 1.1 Cable:

This cable is required to connect RS 232 port (10) to a PC.

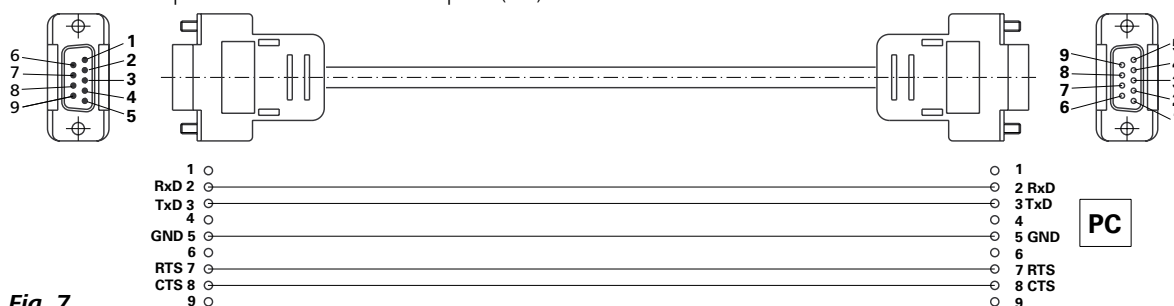

Fig. 7

USB cable A - Micro B 2.0:

This cable is required to connect USB port (11) to a PC.

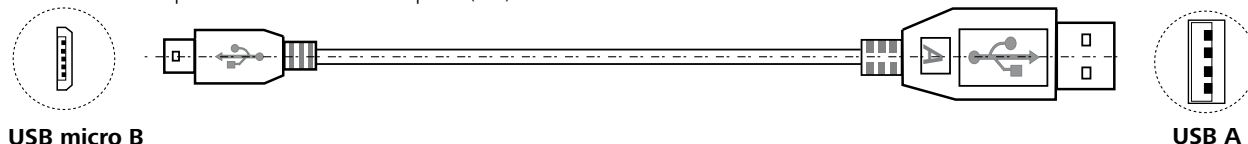

Fig. 8

Device software update

Keep your device up-to-date with the **IKA** Firmware update tool.
The firmware update can be done with a computer connected through USB-Interface or RS 232 interface.
For this, you need register on our website MyIKA first.
After registering your device **IKA** will inform you about available updates for your devices.
Please download the software "FWUToolSetup.zip" from our **IKA** service website www.ika.com.

Maintenance and cleaning

The device is maintenance-free. It is only subject to the natural wear and tear of components and their statistical failure rate.

Cleaning:

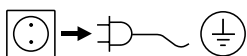

For cleaning disconnect the mains plug!

Use only cleaning agents which have been approved by IKA to clean the devices:

These are: water (containing surfactant) and isopropyl alcohol.

- Wear protective gloves while cleaning the device.
- Electrical devices may not be placed in the cleansing agent for the purpose of cleaning.
- Do not allow moisture to get into the device when cleaning.
- Before using another than the recommended method for cleaning or decontamination, the user must ascertain with **IKA** that this method does not damage the device.

Spare parts order:

When ordering spare parts, please give:

- machine type
- manufacturing number, see type plate
- item and designation of the spare part, see www.ika.com, spare parts diagram and list
- Software version.

Repair:

Please send the device for repair only after it has been cleaned and is free from any materials which may constitute a health hazard.

For repair, please request the "Decontamination Certificate" from **IKA**, or download printout of it from the **IKA** website www.ika.com.

If you require servicing, return the device in its original packaging. Storage packaging is not sufficient. Please also use suitable transport packaging.

Error codes

Any malfunctions during operation will be identified by an error message on the display.

Proceed as follows in such cases:

- ☞ Switch off device using the main switch at the back of the device
- ☞ Carry out corrective measures
- ☞ Restart device

Error code	Effect	Cause	Solution
Err 02	Pump off Heating off	Motor over current (rate current)	- Reduce pump motor speed - Use fluid with lower viscosity - Check if the pump impeller is blocked
Err 03	Pump off Heating off	Motor over current (Max. current)	- Reduce pump motor speed - Use fluid with lower viscosity - Check if the pump impeller is blocked
Err 04	Pump off Heating off	Motor hall signal missing	- Reduce pump motor speed - Use fluid with lower viscosity - Check if the pump impeller is blocked
Err 05	Pump off Heating off	Too high liquid level	- Check the liquid level and buoyage
Err 06	Pump off Heating off	Too low liquid level	- Check the liquid level and buoyage
Err 07	Pump off Heating off	Too high voltage	- Check the mains power

Error code	Effect	Cause	Solution
Err 08	Pump off Heating off	Too low voltage	- Check the mains power
Err 09	Pump off Heating off	Device internal temperature is too high	- Check the ambient temperature and let the device cool down
Err 10	Pump off Heating off	PC communication failure	- Check communication cable
Err 11	Pump off Heating off	Temperature difference between control sensor and safety sensor is too much	- Check safety temperature circuit and bath fluid
Err 12	Pump off Heating off	Safety temperature alarm	- Check the bath temperature measurement
Err 13	Pump off Heating off	Heater switched off by safety circuit	- Check safety temperature set value, fluid level
Err 14	Pump off Heating off	Fan error	- Check the fan and clean the grids at the rear side

If the actions described fails to resolve the fault or another error code is displayed then take one of the following steps:

- Contact the service department;
- Send the device for repair, including a short description of the fault.

Accessories

- **Tubing, hoses, adapters and couplings:**

- LT 5.20** Metal hose (isolated M16 x 1)
- LT 5.21** PTFE hose (isolated M16 x 1)
- H.PVC.8** PVC hose (nominal width 8)
- H.PVC.12** PVC hose (nominal width 12)
- H.SI.8** Silicone hose (nominal width 8)
- H.SI.12** Silicone hose (nominal width 12)

- **Tubing Insulations:**

- ISO. 8** Insulation (8 mm)
- ISO.12** Insulation (12 mm)

- **Bath vessels:**

- IB eco 8** Plastic bath (8 litres)
- IB eco 18** Plastic bath (18 litres)
- IB pro 9** Stainless steel bath (9 litres)
- IB pro 12** Stainless steel bath (12 litres)
- IB pro 20** Stainless steel bath (20 litres)

- **Bridges and Covers:**

- BS.ICC** Small bridge (for **IB eco 8, IB pro 9**)
- BL.ICC** Large bridge (for **IB eco 18, IB pro 12, IB pro 20**)
- CS.ICC** Small cover (for **IB eco 8, IB pro 9**)
- CM.ICC** Medium cover (for **IB pro 12**)
- CL.ICC** Large cover (for **IB eco 18, IB pro 20**)

- **Additional accessories:**

- PCS.ICC** Pump set
- PC 1.1** Cable (RS 232)
- Labworldsoft®**

See more accessories on www.ika.com.

Technical data

Operating voltage	VAC	230 ± 10 % 115 ± 10 % 100 ± 10 %
Frequency	Hz	50/60
Max. input power	W	2100 (230 VAC) 1100 (115 VAC) 860 (100 VAC)
Working temperature range (RT+10 °C at 1000 rpm)	°C	RT + 10 ... 150
Operating temperature range (with forced cooling)	°C	- 20 ... 150
Temperature stability – Internal temperature control 70 °C, water (according to DIN12876)	K	± 0.02
Temperature control		PID
Temperature measurement, absolute accuracy	K	± 0.2
Temperature setting		Button
Temperature setting resolution	K	0.1
Temperature display		LED
Temperature display resolution	K	0.1
Classification according to DIN12876-1		Class III (FL) suitable for flammable and non-flammable fluids
Safety circuit (adjustable)	°C	0 ... 160
Safety temperature display		LED
Heating capacity	W	2000 (230 VAC) 1000 (115 VAC) 760 (100 VAC)
Pump speed (adjustable)	rpm	1000 ... 3200
Max. pump pressure / suction	bar	0.3 / 0.2
Max. flow rate (at 0 bar)	l/min	18
Sub-level protection		Yes
Interface		USB, RS 232
Permitted on-time	%	100
Protection class according to EN 60529		IP 21
Protection class		I
Excess voltage category		II
Contamination level		2
Permitted ambient temperature	°C	+ 5 ... + 40
Permitted ambient humidity	%	80
Dimension (W x D x H)	mm	145 x 200 x 340
Weight	kg	3.75
Operation at a terrestrial altitude	m	max. 2000

Note: Complies to EN61000-3-11 subject to conditional connection: $Z_{max} = 0.282 \Omega$. If necessary, consult your electricity supplier.

Subject to technical changes!

Warranty

In accordance with **IKA** warranty conditions, the warranty period is 24 months. For claims under the warranty please contact your local dealer. You may also send the machine direct to our factory, enclosing the delivery invoice and giving reasons for the claim. You will be liable for freight costs.

The warranty does not cover worn out parts, nor does it apply to faults resulting from improper use, insufficient care or maintenance not carried out in accordance with the instructions in this operating manual.

Pump performance curve

Pump performance curve measured with water:

(Measurements done according DIN 12876-2 with water at 20°C; pump in a closed-loop circuit).

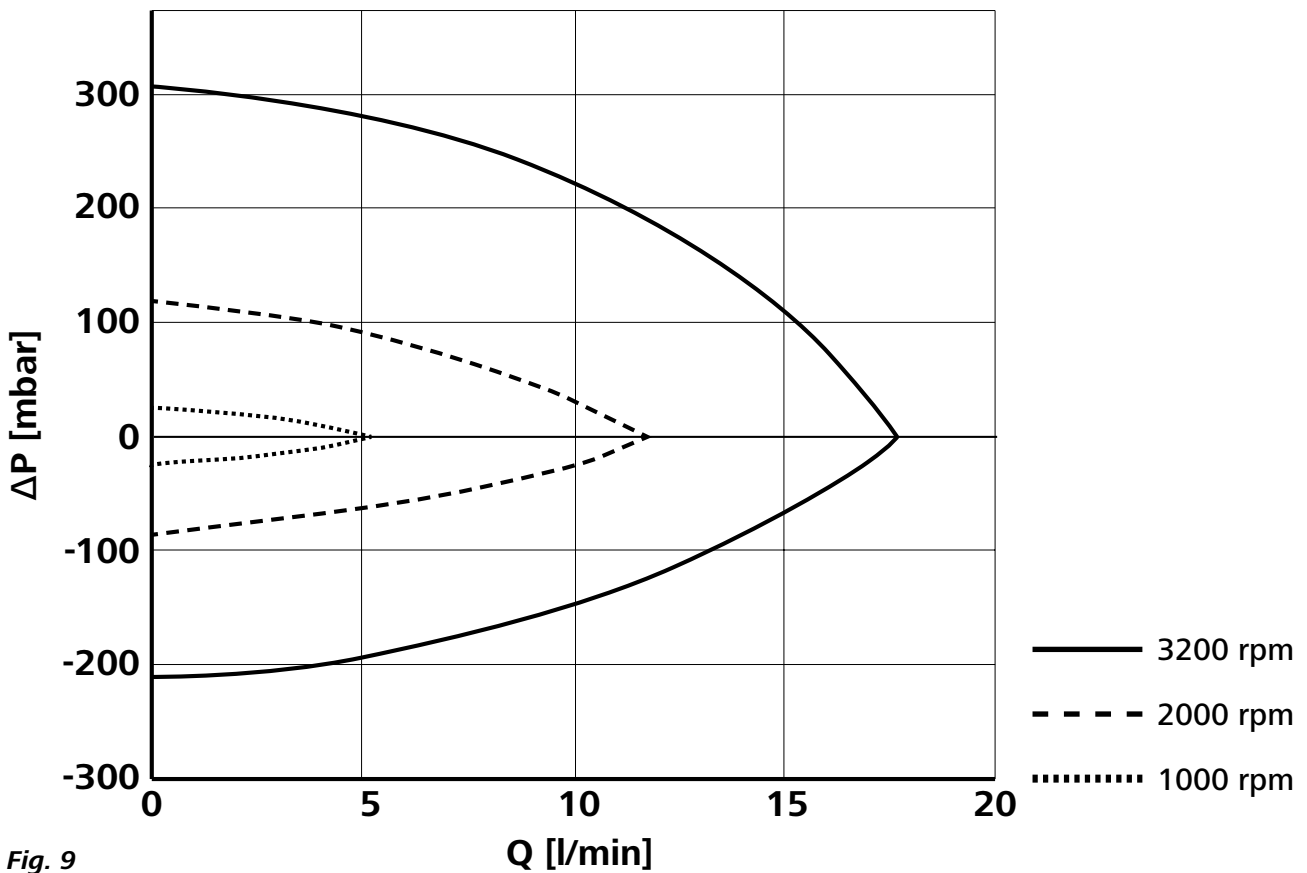

Fig. 9

IKA

designed for scientists

IKA-Werke GmbH & Co. KG

Janke & Kunkel-Straße 10, 79219 Staufen, Germany

Phone: +49 7633 831-0, Fax: +49 7633 831-98

eMail: sales@ika.de

USA

IKA Works, Inc.

Phone: +1 910 452-7059

eMail: usa@ika.net

KOREA

IKA Korea Ltd.

Phone: +82 2 2136 6800

eMail: sales-lab@ika.kr

BRAZIL

IKA Brazil

Phone: +55 19 3772 9600

eMail: sales@ika.net.br

MALAYSIA

IKA Works (Asia) Sdn Bhd

Phone: +60 3 6099-5666

eMail: sales.lab@ika.my

CHINA

IKA Works Guangzhou

Phone: +86 20 8222 6771

eMail: info@ika.cn

POLAND

IKA Poland Sp. z o.o.

Phone: +48 22 201 99 79

eMail: sales.poland@ika.com

JAPAN

IKA Japan K.K.

Phone: +81 6 6730 6781

eMail: info_japan@ika.ne.jp

INDIA

IKA India Private Limited

Phone: +91 80 26253 900

eMail: info@ika.in

UNITED KINGDOM

IKA England LTD.

Phone: +44 1865 986 162

eMail: sales.england@ika.com

VIETNAM

IKA Vietnam Company Limited

Phone: +84 28 38202142

eMail: sales.lab-vietnam@ika.com

Discover and order the fascinating products of IKA online:
www.ika.com



IKAworldwide



IKAworldwide /// #lookattheblue



@IKAworldwide