

Artikelnummer Betriebsanleitung: 1745 9001  
Item no. operating instructions:

**PFEUFFER**

# Operating Instructions

## Sample Divider

### Vario 1G / 2H / 4-8



**Pfeuffer GmbH**  
Flugplatzstraße 70  
97318 Kitzingen  
GERMANY  
Phone: +49 9321 9369-0  
info@pfeuffer.com  
www.pfeuffer.com

Revision 5.1/27.01.2022  
Translation of the original operating instructions



---

These Operating Instructions are a constituent part of the **Vario** Sample Divider and must be available to all operating personnel at all times. They are intended for the operating company of the system, the operating personnel and the specialists who are responsible for the transport, assembly, installation, operation, maintenance, cleaning, disassembly and disposal.

The Pfeuffer GmbH has prepared and reviewed these Operating Instructions with the greatest care. However, no guarantee is made for its completeness or accuracy.

Subject to technical modifications.

---

## **Translation**

If the system is being supplied or subsequently sold to countries of the EEA, the Operating Instructions must be translated into the language of the country of use accordingly. If there are any discrepancies with the translated text, then use the original Operating Instructions (German version) or contact the manufacturer.

## **Operating Instructions in electronic format**

PDFs of the original Operating Instructions (German version) and translations of the original Operating Instructions can be requested by e-mail. Ensure the correct type designation and serial number is stated!

## **© Copyright**

The passing on or reproduction of this document, and use and disclosure of its contents are prohibited unless expressly permitted. We will claim compensation for damages. All rights reserved with regard to the granting of patents, utility models or designs.

(DIN ISO 16016)

<b>1</b>	<b>Introduction.....</b>	<b>5</b>
1.1	Intended use.....	5
1.2	Design characteristics of hazard warnings.....	5
1.3	Pictograms in the Operating Instructions.....	6
1.4	Designation.....	6
1.5	Declaration of Conformity.....	7
<b>2</b>	<b>Safety.....</b>	<b>8</b>
2.1	Installed safety systems.....	8
2.2	Operating and hazard areas associated with the machine.....	9
2.3	Operating and maintenance personnel.....	9
2.4	Safety measures (to be implemented by the operating company).....	10
2.5	General safety instructions.....	11
2.6	Safety tests.....	11
2.7	Residual hazards associated with the Vario Sample Divider.....	11
2.8	Switch-off procedure.....	12
<b>3</b>	<b>Technical data.....</b>	<b>12</b>
3.1	Dimensions and weight.....	12
3.2	Power supply.....	12
3.3	Agitator (option).....	12
3.4	General information.....	13
<b>4</b>	<b>Delivery, transport and storage.....</b>	<b>13</b>
4.1	Scope of delivery.....	13
4.2	Transport and packaging.....	13
4.3	Temporary storage.....	13
4.4	Transport to installation location (of customer).....	14
<b>5</b>	<b>Installation and commissioning.....</b>	<b>15</b>
<b>6</b>	<b>Function.....</b>	<b>16</b>
6.1	Components of Vario Sample Divider.....	16
6.2	Functional sequence.....	17
<b>7</b>	<b>Operation.....</b>	<b>18</b>
7.1	Control elements.....	18
7.1.1	ON/OFF operating switch.....	18
7.1.2	Adjustment lever division ratio.....	18
7.2	Settings.....	18
7.2.1	Dividing time.....	18

---

7.2.2	Circumferential velocity.....	19
7.2.3	Scale.....	19
7.3	Division ratio Vario Sample Divider 1G.....	20
7.4	Division ratio Vario Sample Divider 2H.....	20
7.5	Division ratio Vario Sample Divider 4-8.....	21
7.6	Division of samples.....	21
7.6.1	Scheme Vario Sample Divider 1G/8 (minimal) – scale 4 .....	22
7.6.2	Scheme Vario Sample Divider 1G/8 – scale 22.....	23
7.6.3	Scheme Vario Sample Divider 2H (minimal) – scale 4.....	24
7.6.4	Scheme Vario Sample Divider 2H – scale 22 .....	25
7.6.5	Scheme Vario Sample Divider 4-8 (4 collecting pans) – scale 4 .....	26
7.6.6	Scheme Vario Sample Divider 4-8 (4 collecting pans) – scale 11 .....	27
<b>8</b>	<b>Maintenance and cleaning .....</b>	<b>28</b>
8.1	Cleaning.....	28
8.2	Lubrication.....	28
8.3	Inspection interval and function test .....	29
8.4	General maintenance instructions .....	29
8.5	Check .....	30
<b>9</b>	<b>Malfunctions – causes and rectification .....</b>	<b>30</b>
<b>10</b>	<b>Spare and wearing parts.....</b>	<b>31</b>
<b>11</b>	<b>Supplements and accessories .....</b>	<b>31</b>
<b>12</b>	<b>Emergency.....</b>	<b>33</b>
<b>13</b>	<b>Dismantling and disposal .....</b>	<b>33</b>

## 1 Introduction

### 1.1 Intended use

The **Vario** Sample Divider is used for dividing up samples of grain-like crops (agricultural seed) into sub-samples. The division procedure is used for achieving representative sub-samples.

The **Vario** Sample Divider is designed as a portable device with a power plug for indoor use. The device must not be used as a production machine or in continuous operation!

Private use of the machine is prohibited.

#### **NOTICE**

The **Vario** Sample Divider was designed solely for the aforementioned purpose.

Using it for any other purpose or modifying it without the written consent of the manufacturer is not considered to be in compliance with the intended use. The manufacturer shall not be liable for the resulting damage. Damage caused by such an unintended use is at the sole risk of the operator.

**The Sample Divider is not suitable for the division of**

- **flour, dust and grit**
- **liquid, sticky and oily products**
- **objects made of metal, stone, concrete, plastic or other foreign components.**

The **Vario** Sample Divider is allowed to be operated only if it is ensured that all the safety devices are functional and the system in which this machine is installed complies with the EU directives.

The samples to be used for the correct operation of the **Vario** Sample Divider are provided by the operator.

The operator bears sole responsibility for the proper handling of these materials and the associated dangers.

Hazard notes and instructions for disposal must be provided by the operator.

Intended use includes also the compliance with the Instruction Manual and User's Guide as well as the maintenance and servicing conditions, as specified in these Operating Instructions.

These Operating Instructions do not relieve the operating company of the obligation to develop and to apply independent health and/or safety regulations or safe working processes which are aimed at the requirements of the overall machine, as well as the obligation to monitor their compliance.

### 1.2 Design characteristics of hazard warnings

The Pfeuffer GmbH Operating Instructions contain information which must be observed for the sake of your personal safety and to avoid damage to property. Information concerning your personal safety is shown by means of a triangle.

Note the following categories of hazard warnings and explanation of symbols:

Pictogram



**SIGNAL WORD**



Type of hazard and its source.

Possible result of its disregard.

⇒ Measure to ward off the hazard.

 **DANGER**

warns against a very dangerous situation that results in death or serious injuries.

 **WARNING**











warns against a dangerous situation that can potentially result in death or serious injuries.

 **CAUTION**

warns against a potentially dangerous situation that results in minor or moderate injuries.

**NOTICE** warns against situations that are dangerous for the product and/or the environment.

**1.3 Pictograms in the Operating Instructions**

	Remarks of special importance and/or additional information		Warning
	Follow the Operating Instructions		Warning – Electrical Voltage
	Pull the mains plug		Warning – Hand injuries
	Earth conductor		Warning – Automatic start
	Recycling marking – Supply refuse for recycling		Warning – Tipping and Crushing
	Disposal via general household waste prohibited!		

**1.4 Designation**

Pfeuffer GmbH    Tel. +49 9321 969-0    **PFEUFFER**  
 Flugplatzstraße 70    info@pfeuffer.com  
 97318 Kitzingen    www.pfeuffer.com

**Probenteiler Vario 2H**  
 Sample divider

S/N                    00000000  
 Baujahr/YOM        0000  
 Spannung/Voltage    0000  
 Leistung/Power        0000

  
 Made in Germany

The information provided in these Operating Instructions applies only for the machine whose type designation is specified on the title page.

The identification plate with the type designation is located on the machine housing (front).

Correct information of type designation, serial number and year of manufacture is important for all queries. This ensures fast processing.

**1.5 Declaration of Conformity****EC/EU Declaration of Conformity**

In terms of the directives:

- Machinery 2006/42/EC
- Electromagnetic compatibility (EMC) 2014/30/EU
- Restriction of the use of certain hazardous substances in electrical and electronic equipment (RoHS) 2011/65/EU

Manufacturer: **PFEUFFER**

**Pfeuffer GmbH**  
Flugplatzstraße 70  
97318 Kitzingen  
GERMANY

Phone: 09321 9369-0  
info@pfeuffer.com  
www.pfeuffer.com

This Declaration of Conformity is issued under the sole responsibility of the manufacturer.

Person authorized to compile technical documents:

Lothar Pfeuffer, General Manager

Product: **Vario** Sample Divider

Type:  **1G**     **2H**     **4-8**

Serial number: \_\_\_\_\_

The product mentioned above fulfils the requirements of the following applicable standards:

DIN EN ISO 12100:2011-03+A1:2013

DIN EN 61000-6-2:2019-11

DIN EN 61000-6-3:2011-09+A1:2012-11

EN IEC 63000:2018

This declaration shall become null and void should any alterations be made to the machine without our approval.

Kitzingen, \_\_\_\_\_

\_\_\_\_\_  
Lothar Pfeuffer, General Manager

**2 Safety**

**NOTICE** It is strictly forbidden to disable the safety devices or to change their mode of operation.

**2.1 Installed safety systems**

The installed safety systems must be checked with corresponding test methods at regular testing intervals; refer to the following table:

Test intervals	Test methods
<b>d</b> = daily	<b>VI</b> = visual inspection
<b>w</b> = weekly	<b>FT</b> = functional test
<b>m</b> = monthly	<b>M</b> = measurement
<b>¼ y</b> = quarterly	
<b>½ y</b> = half-yearly	
<b>y</b> = yearly	

**Supply isolating device (plug/socket combination)**

Test	
Interval	Method
<b>y</b>	<b>FT</b>

The plug/socket combination simultaneously functions as an EMERGENCY STOP device.



- ⇒ In case of an emergency, disconnect the Sample Divider from the electrical power supply.
- ⇒ Secure the plug suitably against unauthorized re-plugging by placing it where it can remain under constant supervision.
- ⇒ Ensure that the mains cable is never a tripping hazard or that someone can become caught or step on it.



Set the plug/socket combination in such a way that it can be easily seen and is quickly accessible in case of an emergency.

**System control**

Test	
Interval	Method
<b>y</b>	<b>VI, FT, M</b>

The system is controlled internally with a supply system, a phase and an earth connection (with green/yellow covering for the wires).



**Protective caps**

Test	
Interval	Method
m	VI

During the operation, Sample Divider is protected against interference affecting the machine using protective caps.



Pos.	Designation
1	Removable lid
2	Solid screwed case

Figure 1: Overview - Protective caps model 2H

**2.2 Operating and hazard areas associated with the machine**

**Operating area**

Ensure a sufficient working height (depending on the body size of the operating personnel) of approximately 60-65 cm. For this, a suitable base frame is necessary so that the operating personnel can access the collecting pans ergonomically.

**Hazard area**

The entire area of one meter around the machine is dangerous during adjustment, maintenance and repair work.

⇒ Do not keep any objects around the machine.

**2.3 Operating and maintenance personnel**

Operating and maintenance personnel are responsible for transport, assembly, installation, operation and cleaning of the **Vario** Sample Divider as well as for fault rectification.

1. The Sample Divider is allowed to be operated by authorized personnel and instructed persons only.
2. The responsibilities associated with operating the machine must be clearly defined and adhered to so that there are no unclear competencies concerning safety.
3. The deactivation procedures specified in these Operating Instructions must be adhered to for all tasks (operation, maintenance, repairs etc.) refer to **chapter 2.8**.
4. The operator must forbid all the methods of operation that compromise the safety levels associated with the Sample Divider.
5. The operator must also ensure that only authorized persons work on the Sample Divider.
6. The operator is obliged to immediately inform the operating company about changes in the Sample Divider that compromise safety.
7. The operator must provide the operating personnel with the appropriate protective equipment in accordance with the legal obligations and the material to be processed.

8. The operator must regularly demand that the personal safety equipment is used. The operator must also monitor the usage of this equipment.

#### 2.4 Safety measures (to be implemented by the operating company)

It is noted that the operating company

- ⇒ trains the operating and maintenance personnel with regard to the safety devices of the Sample Divider.
- ⇒ and monitors their compliance with the safety measures.

The frequency of functional tests described in **chapter 8.2** must be adhered to.

The tasks described in these Operating Instructions are listed in such a way that they are

- ⇒ understood by the operating personnel (with regard to the Function and Operation chapters).
- ⇒ understood by skilled personnel (with regard to the chapters Delivery, transport and storage, installation and commissioning, maintenance and cleaning, disruptions – causes and their rectification and Dismantling and disposal).

The chapters Delivery, transport and storage, installation and commissioning, maintenance and cleaning, disruptions – causes and their rectification and Dismantling and disposal are only intended for skilled personnel. Tasks that are described in these chapters must be carried out by skilled personnel only.

#### Instructed person

A person who has been instructed and, if necessary, trained by a skilled worker about the assigned tasks and possible dangers in case of improper behavior, and how has been instructed about the necessary safety devices and safety measures.

#### Skilled worker

An individual who is proficient in identifying risks and avoiding hazards that can occur when using the product, on account of their relevant professional training, education and/or experience.

(Definition as per DIN EN 82079-1:2013-06)

#### Qualified electrician

Person who is in a position to carry out work on electrical systems and independently recognize potential dangers on the basis of their technical training, knowledge and experience and knowledge of the relevant standards and provisions. Qualified electricians are specially trained for the working environment in which they work and have knowledge of the relevant standards and provisions.

#### Obligations of the operator



---

In the European Economic Area (EEA), the national implementation of framework directive 89/391/EEC and the relevant specific directives (especially directive 2009/104/EC "about the minimum requirements for safety and health protection in case of the use of equipment by workers") must be considered and adhered to, with regard to the version that is currently valid.

---

In addition, he/she must comply with the local legal requirements on:

- ⇒ Safety of personnel (accident prevention regulations)
- ⇒ Accident prevention regulation DGUV<sup>1</sup> Regulation 3 (previously BGV A 3) "Electrical systems and equipment"
- ⇒ Safety of work equipment (protective equipment and maintenance)

---

<sup>1</sup> DGUV = Verband der Deutschen Gesetzlichen Unfallversicherung = Association of German statutory insurance

- ⇒ The permissible noise load, depending on the location and the time of day (in Germany, TRLV<sup>2</sup> apply)
- ⇒ Product and material disposal (waste legislation)
- ⇒ Cleaning (cleaning agents and disposal)
- ⇒ Hazardous substances (in Germany, TRGS<sup>3</sup> 555 apply)
- ⇒ Environmental protection regulations

### Electrical connections



The Sample Divider may only be connected to a correctly-earthed socket with an earth conductor.

## 2.5 General safety instructions



The safety equipment and safety instructions described in these Operating Instructions must be borne in mind.



1. Disconnect the Sample Divider from the mains in case of malfunctioning.
2. Disconnect the Sample Divider from mains before starting with the cleaning operation.
3. Do not let the Sample Divider get wet during transport, storage, cleaning and operation.
4. Make sure that you only use the Sample Divider when it is in a defect-free condition.
5. Never touch the mains cable with wet hands.
6. Always use original spare parts and accessories (refer to **chapter 10** and **11**).

## 2.6 Safety tests

The following safety tests have been conducted by Pfeuffer GmbH at the plant:

Test and inspection as per standard DIN EN 60204-1:

- Inspection to verify that the electrical equipment complies with the technical documentation.
- Continuous connection of protective conductor system
- Insulation resistance tests
- Voltage tests
- Functional tests

The functions of the electric equipment, especially those that relate to safety and safety measures, have been tested.

## 2.7 Residual hazards associated with the Vario Sample Divider

- ⇒ Pay attention to electrical hazards in case of all tasks that are to be carried out vis-a-vis electrically-operated components.
- ⇒ Be mindful of crushing hazards when setting up, servicing, repairing and operating the machine.
- ⇒ Make sure that the Sample Divider starts automatically when the mains plug is plugged in and the power supply is periodic.

<sup>2</sup> TRLV = Technical rule for the noise and vibration occupational health and safety ordinance

<sup>3</sup> TRGS = Technical rule for hazardous substances

**2.8 Switch-off procedure**



**! DANGER**

**Touching live parts can be fatal!**

The following deactivation procedure must be carried out before cleaning, maintaining or repairing the machine (only by skilled personnel):

⇒ Deplete the Sample Divider.



⇒ Unplug the Sample Divider by disconnecting the power plug from the electrical power supply.

⇒ It must be possible to ensure that the plug remains under the direct supervision of the person in the hazardous area.

⇒ Make sure that water, vapor or dust cannot enter the electronic area when cleaning.

**3 Technical data**

Sample Divider <b>Vario</b>	Division of all grain crops
Sample quantity	ca. 1-8 kg
Material/transported material	Grains, peas, rape seed, maize and similar granular bulk goods

**3.1 Dimensions and weight**

	Model 1G	Model 2H	Model 4-8
Height	800 mm	840 mm	840 mm
Width	465 mm	485 mm	550 mm
Length	492 mm	492 mm	492 mm
Weight	65 kg	60 kg	72 kg

**3.2 Power supply**

Supply voltage/Frequency	230 V ~ 50/60 Hz (115 V ~ 60 Hz on request)
Power	100 VA
Power consumption	60 W
Number of phases	1 Ph / PE
Earth conductor	PE (yellow/green) in mains cable
Frequency	±1 %
Installation instructions	Executed as per VDE <sup>4</sup>

**3.3 Agitator (option)**

Supply voltage/Frequency	230 V ~ 50 Hz
Power	6 VA
Protection level according to DIN EN 60529	IP10
Installation instructions	Executed as per VDE

<sup>4</sup> VDE = Association for Electrical, Electronic & Information Technologies (Germany)

### 3.4 General information

Ambient temperature storage and transport	-10 °C to +60 °C
Ambient temperature during operation	+5 °C to +40 °C
Humidity	20 % to 80 % non-condensing
Acoustic level	L <sub>PA</sub> = 60 dB <sub>(A)</sub> as per measurement report
Protection level according to DIN EN 60529	IP 10 (Housing), IP 54 (Motor)

## 4 Delivery, transport and storage



The chapter Delivery, transport and storage is intended for **skilled personnel** only.

### 4.1 Scope of delivery

The scope of delivery to the operator includes:

**Vario** Sample Divider **1G** with standard funnel Item no. 1745 0057  
(Capacity ca. 3 kg) Ø 48 mm / 12 kg/min

- 1 PVC collecting pan, 1 Sample pan for flow, Operating Instructions

**Vario** Sample Divider **2H** with standard funnel Item no. 1745 0050  
(Capacity ca. 3 kg) Ø 48 mm / 12 kg/min

- Extension funnel capacity up to 8 kg, 2 PVC collecting pans, 1 Sample pan for flow, Operating Instructions

**Vario** Sample Divider **4-8** with standard funnel Item no. 1745 0053  
(Capacity ca. 3 kg) Ø 48 mm / 12 kg/min

- Accessories according to delivery order, Operating Instructions

### 4.2 Transport and packaging

Systems and machines of Pfeuffer GmbH are carefully checked and packaged before dispatching. However, damages during the transport cannot be excluded.

#### Intake control

Run a completeness check using the delivery note.

#### In case of damages

Check the delivery for damages (visual inspection).

#### In case of complaints

If the delivery has been damaged during transport:

- ⇒ Retain the packaging (for the dispatcher to inspect or for return delivery).
- ⇒ Immediately inform the suppliers or Pfeuffer GmbH.

### 4.3 Temporary storage

Freight packaging of the Vario Sample Divider and exchange parts and accessories is intended for a storage duration of six months upon delivery.

#### Storage conditions

Closed and dry room with a room temperature from minimum -10 °C to maximum +60 °C.

**4.4 Transport to installation location (of customer)**



The machine must be transported by skilled personnel only and in accordance with the local conditions and, if applicable, the information on the packaging material.

Sample Divider is supplied to the installation location of the customer on a transportation pallet.

**! CAUTION**



**The Sample Divider can tip over during transport!**

**No-one is allowed in the danger area!**

- ⇒ Pay attention to the center of gravity and the weight.
- ⇒ Secure the Sample Divider with appropriate slings before transport.
- ⇒ Keep an adequate safe distance.

**Transport with forklift truck**

Packing items that are packaged on pallets or in boxes can be transported by a crane under the following conditions:

- The crane and lifting equipment must be designed for the weight of the packing items.
- The operator must be authorized to use the crane.

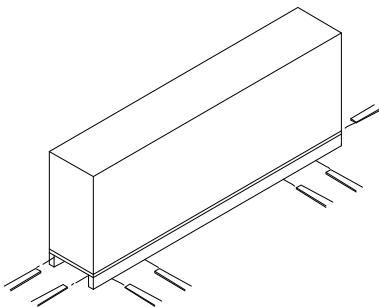

**Lashing:**

- ⇒ Drive so the tines of the forklift truck pass between or underneath the spars of the pallet/crate. The tines must protrude on the opposite side!

Figure 2: Diagram of transport by forklift

**Unpacking:**

In order to avoid damages to the casing and other components,

- ⇒ Open the packaging by cutting the tension bands.
- ⇒ Remove the fibreboard cover and remove the styrofoam packaging elements.
- ⇒ Lift the Sample Divider with at least two people from the transport pallet.
- ⇒ Pay attention to the specific weight, see **chapter 3**.
- ⇒ Drive the Sample Divider with a sack barrow to the installation location.

**Packaging for return delivery**

- ⇒ If possible, use the original packaging and the original packaging material. If neither is available any longer, request new packaging from Pfeuffer GmbH.

**! WARNING****Risk of suffocation**

Packaging materials (e.g. film, polystyrene, cardboard boxes) can be dangerous to children.



- ⇒ Keep packaging material away from children.
- ⇒ Do not leave packaging material lying around carelessly.
- ⇒ Dispose of packaging material in an environmentally friendly way.

**5 Installation and commissioning**

The chapter Installation and commissioning is intended for **skilled personnel** only.

**Positioning of Sample Divider**

- ⇒ Unpack the Sample Divider carefully (refer to **chapter 4.4**) and place it horizontally.
- ⇒ Ensure that a firm footing on a non-slip surface is provided.
- ⇒ Avoid exposure to direct sunlight and extreme ambient conditions.
- ⇒ Make sure that the installation height is ergonomic according to the stature of the operating personnel.



A correct horizontal positioning of the machine guarantees an even division of the grains.

- ⇒ Check if all the components are firmly secured.
- ⇒ Re-tighten all the screws and clamps.

**! CAUTION****Unexpected automatic start of the Sample Divider!**

If the operating switch is activated (**ON** position) and there is a periodic power supply, the Sample Divider starts up automatically.

- ⇒ Keep the operating switch in the **OFF** position, before connecting the Sample Divider to the electrical power supply.

- ⇒ Ensure that the mains cable is never a tripping hazard or that someone can become caught or step on it.



- ⇒ Insert the mains plug into a correctly-earthed socket with an earth conductor.

- ⇒ Activate the Sample Divider keeping in mind all the specifications given in **chapter 7**.

**6 Function**

**6.1 Components of Vario Sample Divider**

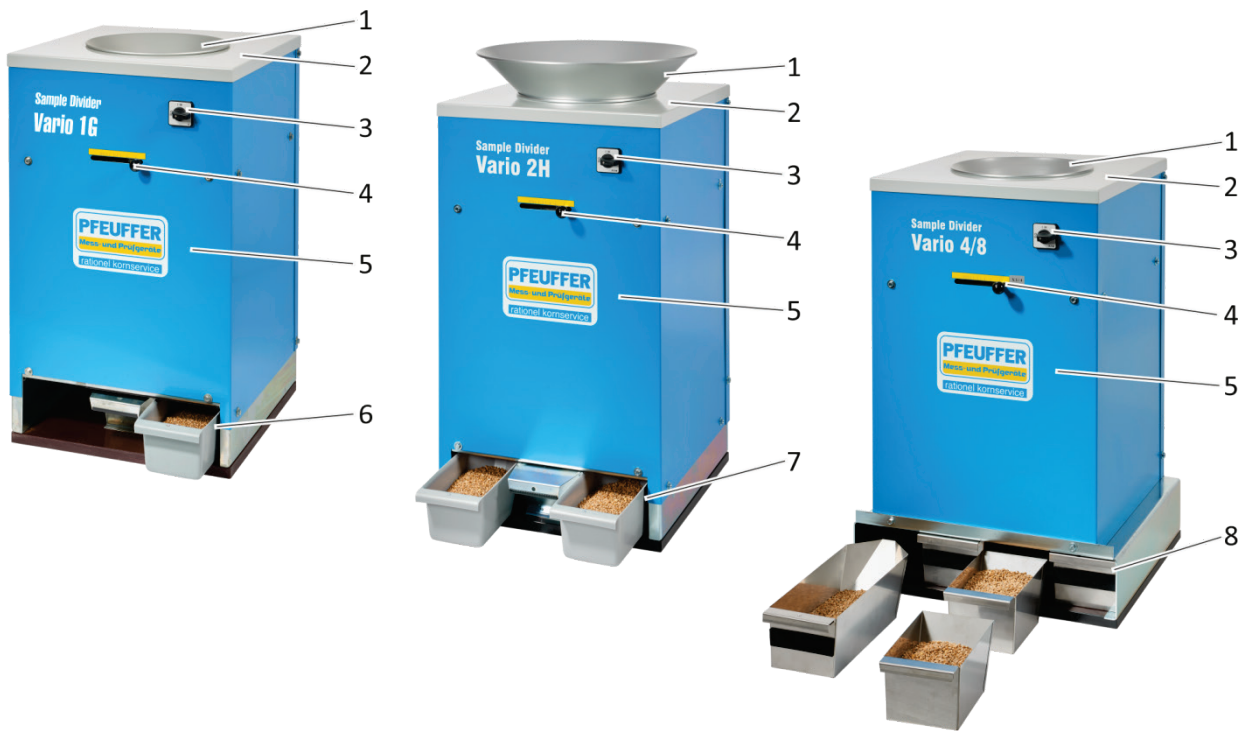

Figure 3: Overview – Model 1G, 2H, 4-8

Pos.	Designation
1	Filling funnel Figure of Sample Divider Vario 2H including extension funnel capacity up to 8 kg (option)
2	Machine cover
3	Operating switch
4	Adjustment lever for division ratio
5	Housing of the rotary distributor with motor, timing belt and distributor arm
6	Housing with two insertion chambers for collecting pan or sample pan for flow
7	Housing with three insertion chambers for collecting pan or sample pan for flow
8	Housing with four insertion chambers for up to 8 collecting pans or sample pans for flow



Item numbers for supplements and accessories can be found in **chapter 11**.



## 6.2 Functional sequence

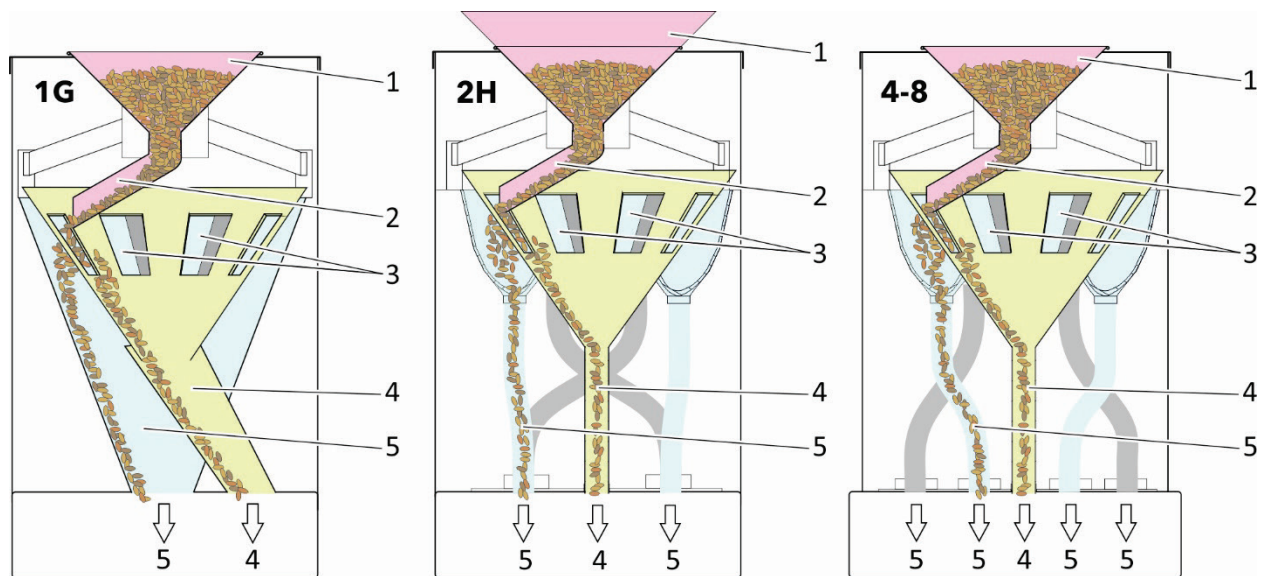

Figure 4: Functional sequence Vario Sample Divider 1G, 2H and 4-8

Pos.	Designation
1	Fill in the sample
2	Rotating distributor arm
3	Adjustable sample chambers
4	Surplus sample material
5	Sample outlet: <b>1G</b> = 1 sample <b>2H</b> = 2 samples <b>4-8</b> = 4 or 8 samples (depending on the used collecting pan)

The **Vario** Sample Dividers **1G**, **2H**, **4-8** are used for evenly dividing all grain-like crops.

Set the division ratio on the adjustment lever and fill the sample into the filling funnel.

The machine starts up when you set the operating switch to **ON**. The rotating distributor arm turns and passes the eight variably adjustable sample chambers. The partial samples reach the collecting pans alternately via a system of pipes (In the **Vario 1G** through a funnel).

The surplus sample material flows through the middle and can be collected in a large collecting pan.

**7 Operation**



Sample Divider is allowed to be operated by qualified and trained persons only.

**7.1 Control elements**



Pos.	Designation
1	ON/OFF operating switch
2	Adjustment lever division ratio

Figure 5: Control elements – Vario Sample Divider Model 2H

**7.1.1 ON/OFF operating switch**

The **ON/OFF** operating switch starts and ends the dividing process.

**7.1.2 Adjustment lever division ratio**

With this lever, the division ratio is adjusted based on the yellow scale.

**7.2 Settings**

The **Vario** Sample Dividers have 8 outlets and one surplus outlet. 8, 4 or 2 outlets are grouped together for the sample depending on the model:

<b>Model 1G8</b>	<b>Model 2H</b>	<b>Model 4-8</b>
8 outlets for a sample	4 outlets per sample	2 or 1 outlet(s) per sample

**7.2.1 Dividing time**

The distributor arm of the Sample Divider turns at a speed of 40 rpm (revolutions per minute) in the dividing process. This means one rotation takes about 1.5 seconds (s). In each rotation, the eight outlets are passed over/loaded once.

In order to obtain a representative partial sample, it should consist of at least 40 individual samples. This means the following minimum dividing time must be observed for the various models:

<b>Model 1G8</b>	40 individual samples =	8x5 rotations → 5x1,5 s = <b>7.5 s</b>
<b>Model 2H</b>	40 individual samples =	4x10 rotations → 10x1,5 s = <b>15 s</b>
<b>Model 4-8</b>	40 individual samples =	2x2 rotations (4 samples) → <b>30 s</b> 1x4 rotations (8 samples) → <b>60 s</b>



The Pfeuffer GmbH recommends a dividing time of at least 20 seconds.

The time taken for each product to pass through can be influenced by the funnel outlet. The following accessories are available for this:

	Pass-through time depending on the product
Standard funnel $\varnothing$ 48 mm	approx. 12 kg/min
Funnel $\varnothing$ 30 mm:	approx. 8 kg/min
Insert for funnel passage $\varnothing$ 25 mm	approx. 4 kg/min
Insert for funnel passage $\varnothing$ 20 mm	approx. 2 kg/min



For the item numbers of the inserts to reduce the outlets on the funnel with  $\varnothing$  30 mm, refer to **chapter 11**.

### 7.2.2 Circumferential velocity

The distributor arm turns at a speed of 40 rpm in the dividing process. There is no provision for adjusting the speed.

### 7.2.3 Scale

The division ratio can be set using the adjustment lever and the scale on the front of the device. The specified number stands for the division ratio. Number 4 means a division ratio of 1:4. If you fill a 4 kg sample (in the **Vario 2H**) you will get two samples of 1 kg each and 2 kg surplus amount. The left side of the square profile on the adjustment lever must be against the line on the scale.

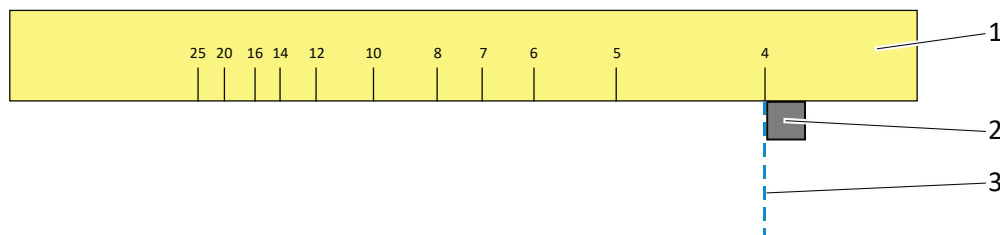

Figure 6: Scale

Pos.	Designation
1	Yellow scale
2	Adjustment lever
3	Setting 1:4



In addition, and in particular for the **Vario 1G** and **Vario 2H** Sample Dividers, stainless steel cover plates can be supplied by means of which the division ratio can be further reduced. Separate installation instructions are supplied, for the item number refer to **chapter 11**.

**7.3 Division ratio Vario Sample Divider 1G**

Sample number	1			
Sample Divider	1G8	1G4	1G2	1G1
Sample chambers	8	8 / 4 covered	8 / 6 covered	8 / 7 covered
Product	Division ratio	Division ratio	Division ratio	Division ratio
Rape	1:2 to 1:15	1:4 to 1:30	1:8 to 1:60	1:16 to 1:120
Grain	1:2 to 1:11	1:4 to 1:22	1:8 to 1:44	1:16 to 1:88
Peas	1:2 to 1:6	1:4 to 1:12	1:8 to 1:24	1:16 to 1:48

On the **Vario 1G**, if the maximum division ratio is 1:11 (1G8), this can be increased by covering four sample chambers, to give 1:22 (1G8), this can be increased by covering six sample chambers, to give 1:44 (1G8), this can be increased by covering seven sample chambers, to give 1:88 (1G1).

**Setting the division ration on Sample Divider 1G:**

1G/8	Divide the display scale with 2
1G/4	Display of the scale
1G/2	Multiply the display scale with 2
1G/1	Multiply the display scale with 4

Example:

- ⇒ Set the scale to 8 (division ratio when using a 1G/8 = 1:4).
- ⇒ Fill a sample with a total weight of 6 kg into the Sample Divider.
- ⇒ After the division into the collecting pan, you obtain a 1.5 kg sample.
- ⇒ The surplus sample material amounts to 4.5 kg.

Further examples see schemes in **chapter 7.6.1** and **7.6.2**.

**7.4 Division ratio Vario Sample Divider 2H**

Sample number	2
Product	Division ratio
Rape	1:4 to 1:30
Grain	1:4 to 1:22
Peas	1:4 to 1:12

On the **Vario Sample Divider 2H**, if the maximum division ratio is 1:22 this can be increased by covering four outlets, to give 1:44, or can be increased by covering six outlets, to give 1:88.

Example:

- ⇒ Set the scale to 8 (division ratio 1:8).
- ⇒ Fill a sample with a total weight of 6 kg into the Sample Divider.
- ⇒ After the division into each collecting pan (2x), you obtain a 750 g sample.
- ⇒ The surplus sample material amounts to 4.5 kg.

Further examples see schemes in **chapter 7.6.3** and **7.6.4**.

**7.5 Division ratio Vario Sample Divider 4-8**

Sample numbers	4 or 8
Product	Division ratio
Rape	1:8 to 1:120
Grain	1:8 to 1:88
Peas	1:8 to 1:48

**Setting the division ration on Sample Divider 4-8:**

4 collecting pans = 4 samples	Multiply the display scale with 2
8 collecting pans = 8 samples	Multiply the display scale with 4

Example:

- ⇒ If using 8 collecting pans, set the scale to 4 (division ratio 1:16).
- ⇒ Fill a sample with a total weight of 8 kg into the Sample Divider.
- ⇒ After the division into each collecting pan, you obtain a 500 g sample.
- ⇒ The surplus sample material amounts to 4 kg.

Further examples see schemes in **chapter 7.6.5** and **7.6.6**.

**7.6 Division of samples**

- ⇒ Place one collecting pan under each of the outlets at the intended points.
- ⇒ Set the division ratio using the adjustment lever and the scale.
- ⇒ Switch on the Sample Divider using the ON operating switch.
- ⇒ Pour the sample into the infeed funnel in one movement.
- ⇒ Once the entire sample has run through, set the operating switch to OFF.
- ⇒ Empty the collecting pans.
- ⇒ Repeat the process with a new sample.



When dividing maize, it will be necessary to use an agitator. You can obtain this from Pfeuffer GmbH, see **chapter 11**.

**NOTICE**

Make sure that no objects drop into the infeed funnel!  
These could damage the Sample Divider when the dividing process starts.

7.6.1 Scheme Vario Sample Divider 1G/8 (minimal) – scale 4

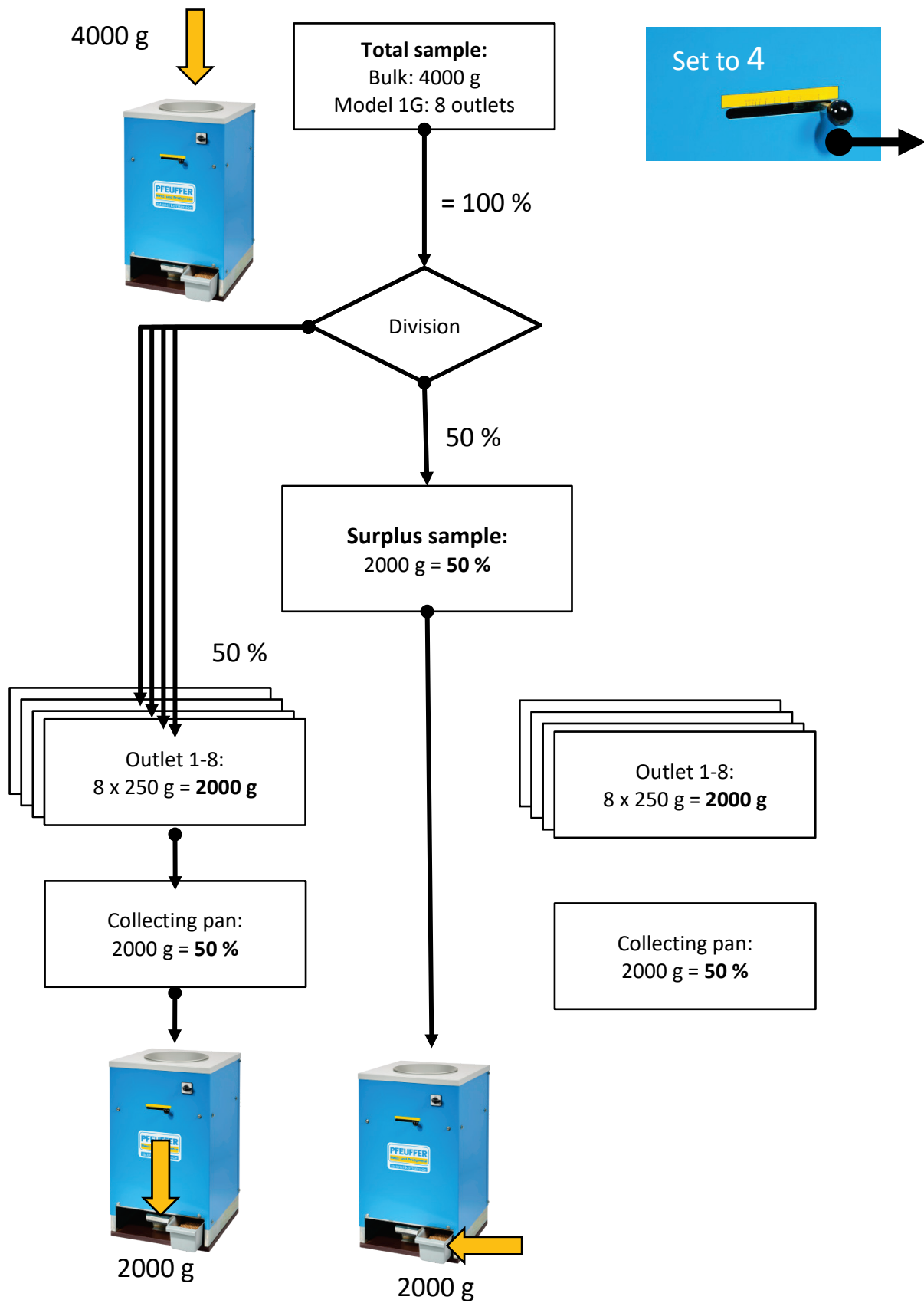

**7.6.2 Scheme Vario Sample Divider 1G/8 – scale 22**

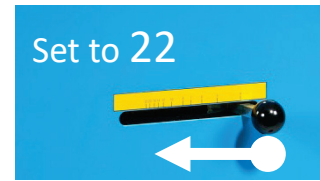
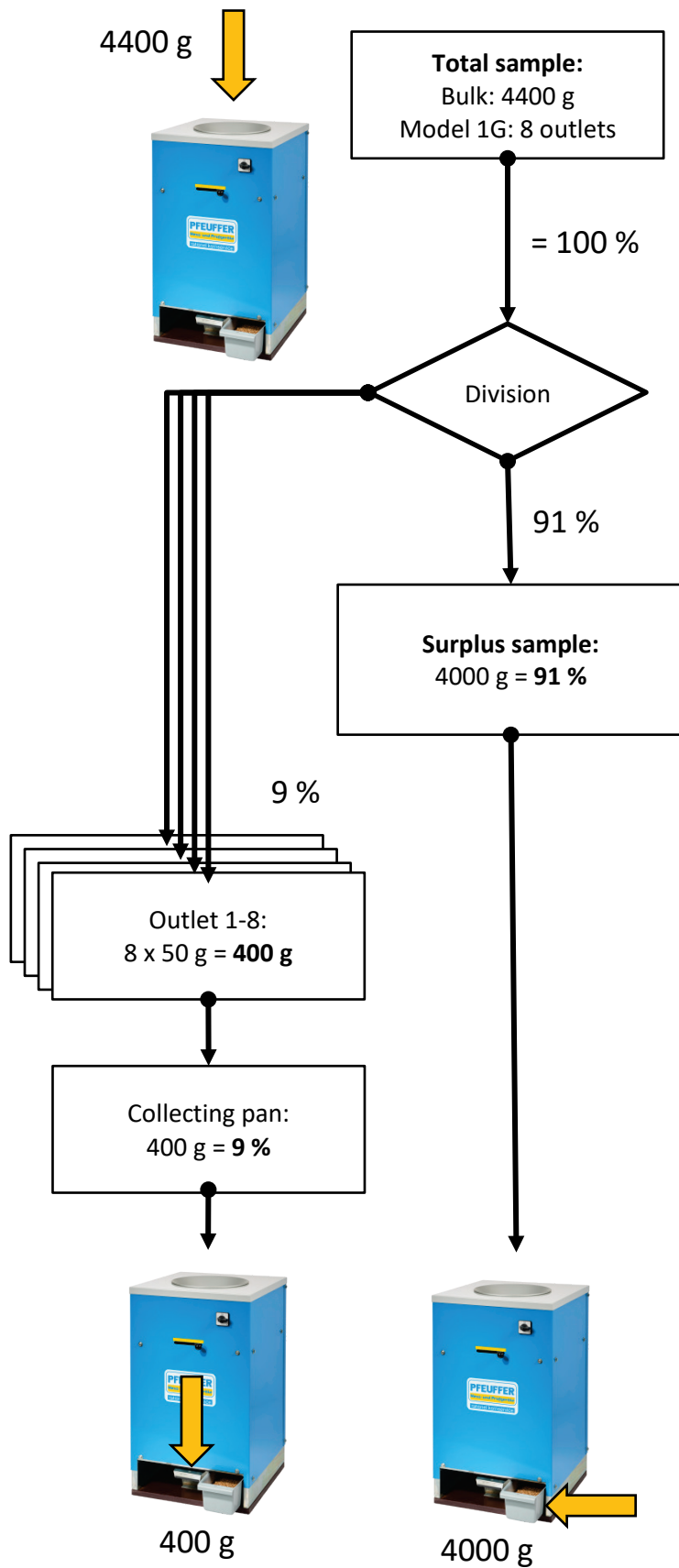

7.6.3 Scheme Vario Sample Divider 2H (minimal) – scale 4

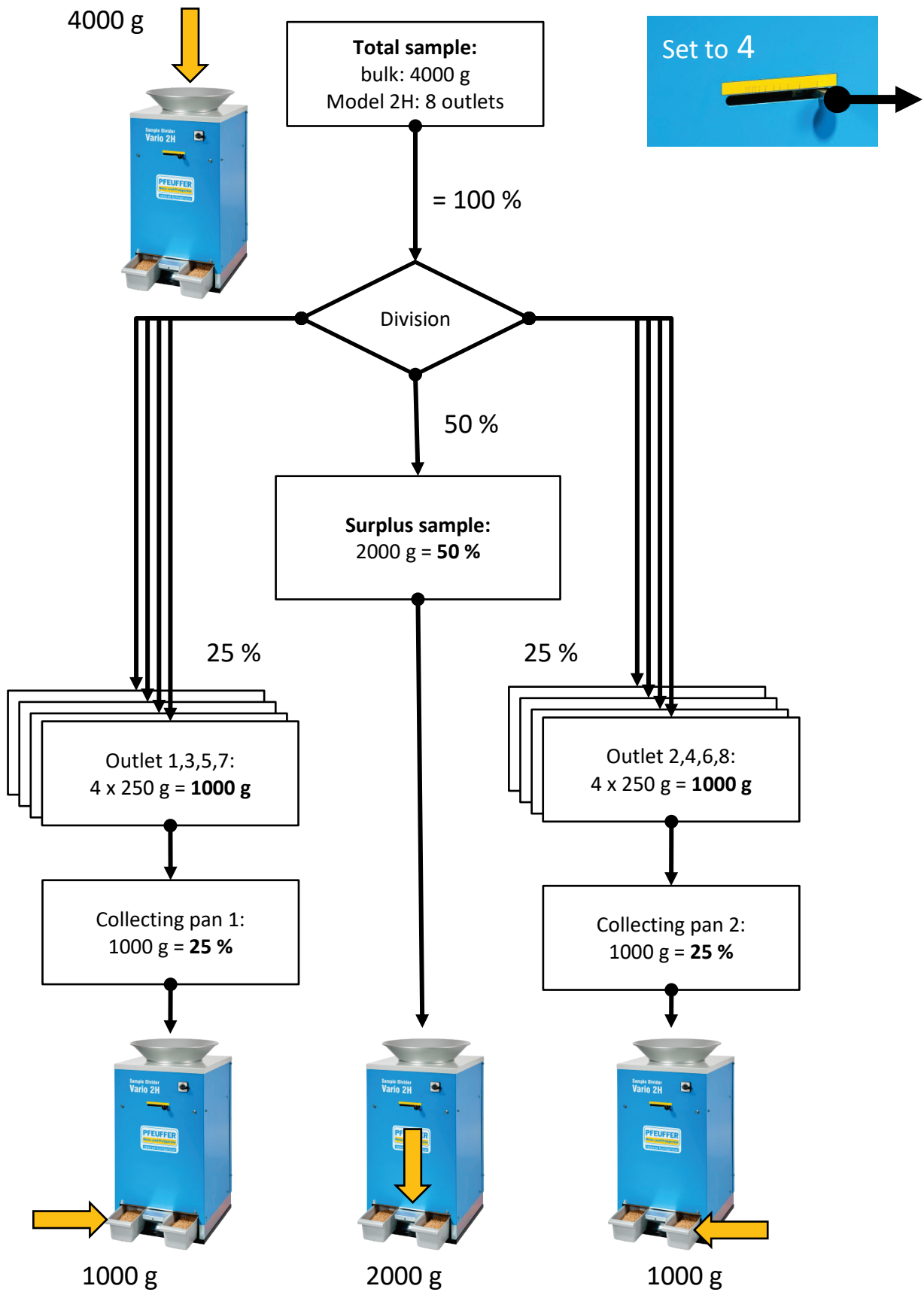



**7.6.4 Scheme Vario Sample Divider 2H – scale 22**

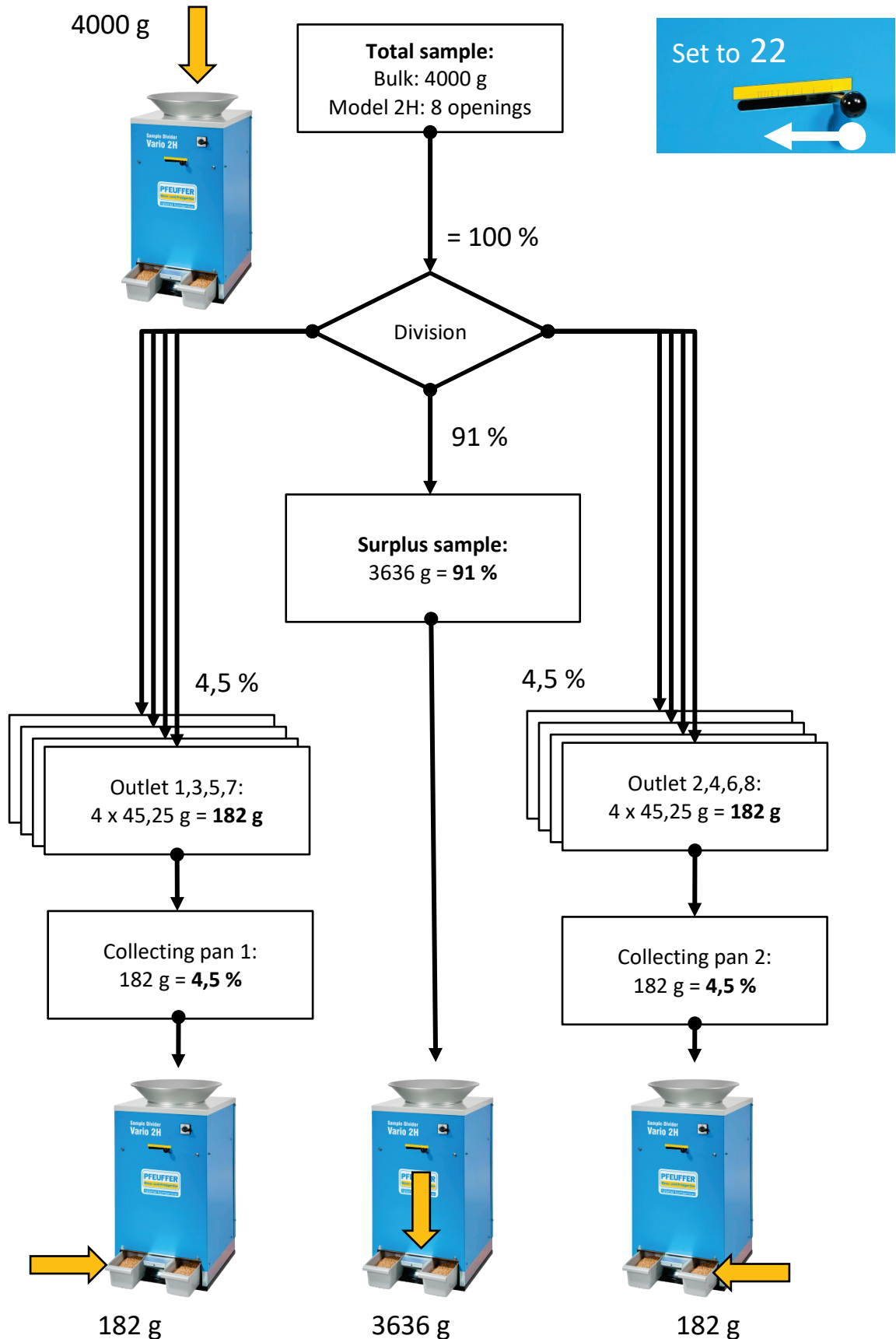

7.6.5 Scheme Vario Sample Divider 4-8 (4 collecting pans) – scale 4

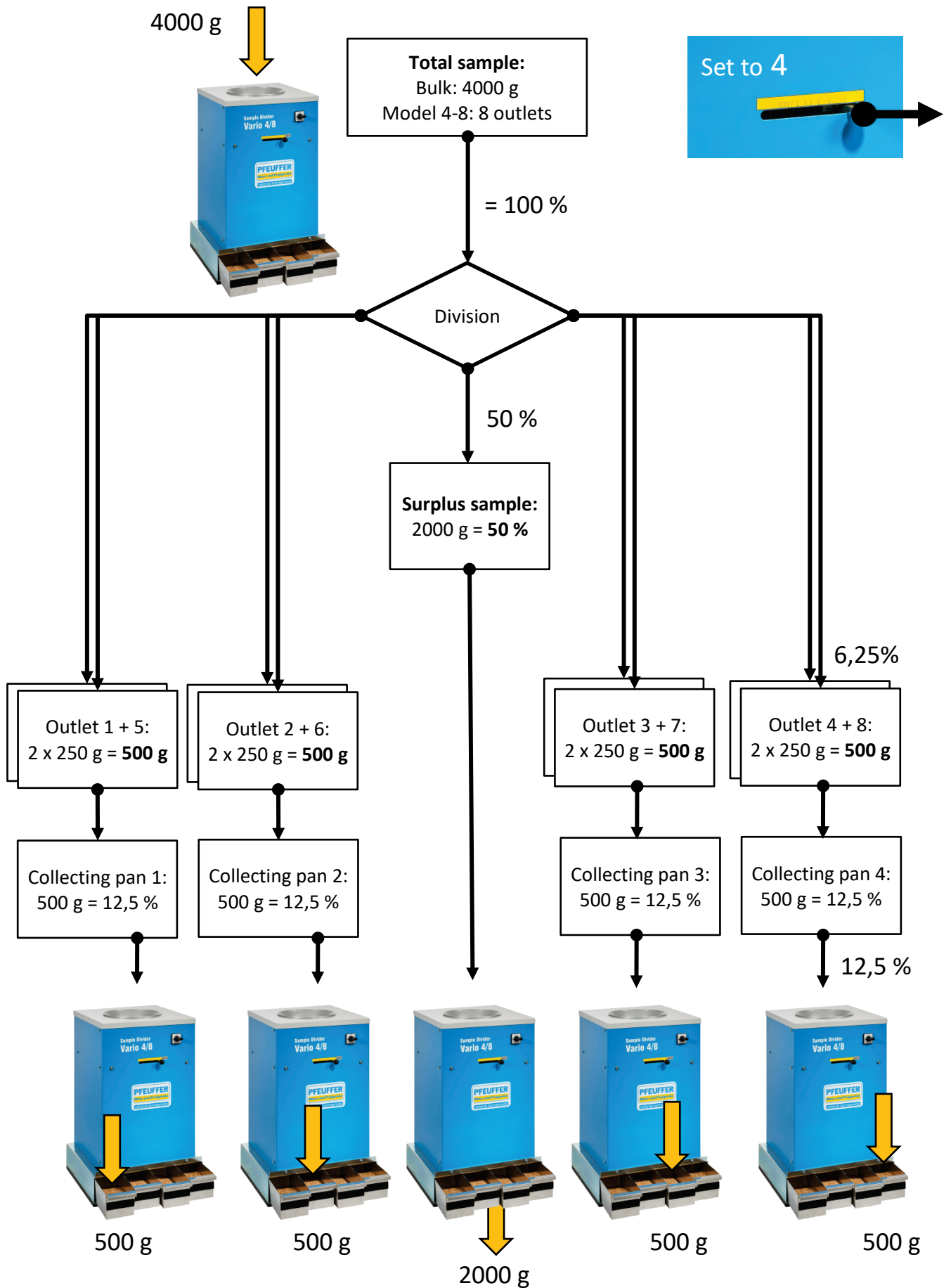

**7.6.6 Scheme Vario Sample Divider 4-8 (4 collecting pans) – scale 11**

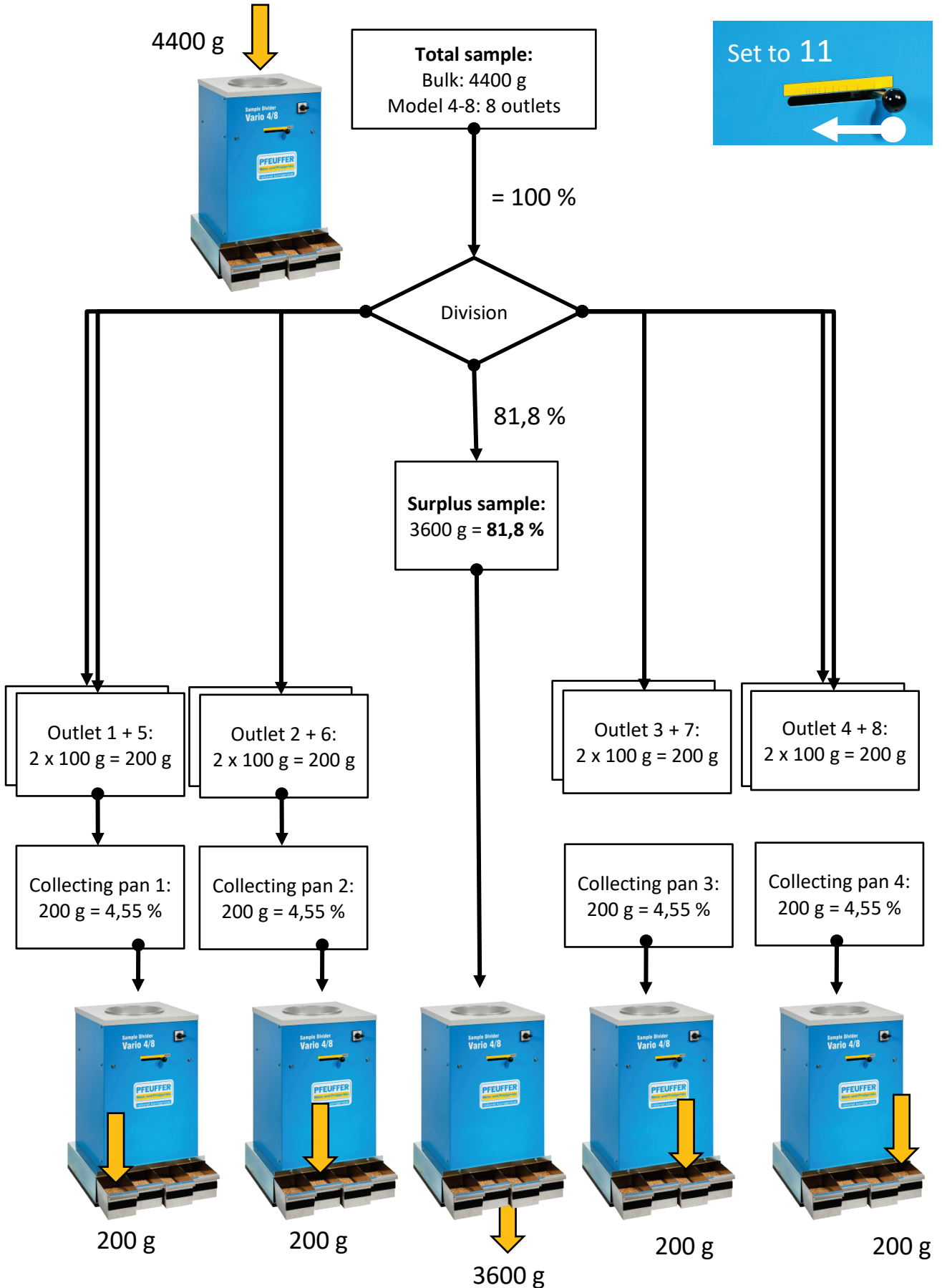

**8 Maintenance and cleaning**



The chapter maintenance and cleaning is intended for **skilled personnel** only.

**NOTICE** Opening the housing and inappropriate operation will invalidate the warranty.

In order to guarantee a failure-free operation of the Sample Divider, it is absolutely necessary that the machine is regularly cleaned and maintained.

**! DANGER**



**Touching live parts can be fatal!**

It is essential to comply with the switch-off procedure prior to cleaning, maintenance or repair work! (see **chapter 2.8**)

- ⇒ During all work that is required, wear personal protective equipment according to the company health and safety regulations.
- ⇒ Pay attention to local statutory accident prevention regulations!



The times for carrying out cleaning and maintenance work are based on one-shift working (8 hour/day, 22 days/month, 12 months/year).

- |                         |   |
|-------------------------|---|
| <b>d</b> = daily        | $\frac{1}{3}$ <b>y</b> = every three months |
| <b>w</b> = weekly       | $\frac{1}{2}$ <b>y</b> = every six months   |
| <b>m</b> = monthly      | <b>y</b> = yearly                           |
| <b>ar</b> = as required |   |

**NOTICE** The operating company must provide hazard and disposal information.

**NOTICE** Following cleaning, maintenance or exchanging wearing parts, check that all safety devices are functioning correctly.

**8.1 Cleaning**

**NOTICE** Do not use any sharp objects or tools for cleaning. Only use objects that are expressly intended for this purpose.  
During cleaning, make sure that no water, steam or dust can penetrate the electronics area.

**Motor**

Excessive dust deposit on the motor can lead to overheating and failure.

- ⇒ Clean the motor with a dry cloth and / or compressed air.

**8.2 Lubrication**

Maintenance-free bearings are used in the Sample Divider. Lubrication is not required.

### 8.3 Inspection interval and function test

Sub-assembly	Interval in one-shift working				
	w	m	¼ y	½ y	y
Normal function tests:					
Main switch I/O		X			
Mains isolator (plug/socket combination)					X
Mains cable and connection					X
Markings and warnings present and legible (via visual inspection)					X
Check the correctness and firm fit of the entire machine			X		
Check if wires are tight					X
Check all cables for damage and aging				X	
Check protective covers for defects, as well as for correct and tight fit		X			
Check whether all the plug, screw and clamped connections are tight and if necessary, re-tighten them			X		
Check the belt tension and inspect for damages					X
Functional test of the drive motors				X	
Electrical test as per VDE <sup>5</sup>	see DGUV regulation 3				

**DANGER**

**Damaged cables increase the risk of getting an electric shock!**



- ⇒ Never touch a damaged cable (e.g. cable that has been cut into, insulation damaged etc.)
- ⇒ Disconnect the cable from the electrical power supply immediately.
- ⇒ Replace the cable with a new one.

### 8.4 General maintenance instructions

Maintenance is a part of servicing and refers to the scheduled cleaning, checking and replacement of wearing parts. The aim of maintenance is to maintain the full functionality of the device over its lifetime.

The **Vario** Sample Divider should therefore be checked for wear and tear at regular intervals. The inspection intervals depend on the significance of the frequency of use and the ambient conditions to which the **Vario** Sample Divider is exposed. Only through regular checks (visual inspection) can damage to the device caused during use be detected early and reliably. We therefore recommend that this check will be carried out at least once a year, preferably after the harvest period.

<sup>5</sup> VDE = Association for Electrical, Electronic & Information Technologies (Germany)

Check	Interval
Correct and secure position of the gear motor and the torque transfer elements	½ y
Wear and tear of the gear motor and the torque transfer elements	½ y
Correct and secure position of protective cladding	m

**8.5 Check**

After the work has finished, check:

- ⇒ The completeness of the work carried out.
- ⇒ That there are no tools in the machine.
- ⇒ The wiring in the switch box for breaks, chafe marks or burns.
- ⇒ The covers or insulations for damages.
- ⇒ Close the cover of the switch box.
- ⇒ A function of all assemblies in setting or manual mode.
- ⇒ The safety equipment for proper functioning.
- ⇒ If all the functions are error-free, the machine is handed over to the operator.

**9 Malfunctions – causes and rectification**



The information provided in this chapter about possible malfunctions is structured to be understood by specialists in electrical, electronic or mechanical maintenance. Appropriate tools and test instruments must be provided to these personnel. If the specified measures do not prove successful, contact Pfeuffer GmbH. It is important for all questions to specify the correct type designation, serial number and year of manufacture. Only in this way will rapid processing be possible. The information can be found on the type plate.

**! DANGER**



**Touching live parts can be fatal!**

It is essential to comply with the switch-off procedure prior to cleaning, maintenance or repair work! (see **chapter 2.8**)

Problem	Cause	Rectification
Machine does not show any function.	System voltage not available.	Get the system voltage checked and activated by an <b>electrically skilled person</b> .
	Operating switch ON/OFF remains at OFF.	Switch the operating switch ON.
	Internal fuse defective.	Checking and replacement by an <b>electrically skilled person</b> .

## 10 Spare and wearing parts

**NOTICE**

We wish to point out expressly that replacement and accessory parts not supplied by us will not have been tested and approved by us either. Installing and/or using such products can thus result in the design properties of the **Vario** Sample Divider being negatively impaired. Pfeuffer GmbH cannot be held liable for damage attributable to the use of non-genuine parts and non-genuine accessories.

Standard parts can be obtained from the dealer.

Spare part	Item number
Gear motor	3251 1760
Capacitor gear motor	3222 4670
Timing	3122 1750

**NOTICE**

Replacement works on the motor, V-belt gear and switch box should be carried out by a skilled person only; refer to **chapter 2.3**.

In case of questions, please contact Pfeuffer GmbH.

## 11 Supplements and accessories

Product	Item number
Standard funnel Ø 48 mm	3331 0500
Extension funnel capacity up to 8 kg	3331 0510
Funnel Ø 30 mm (9 kg/min)	3331 0520
Insert for funnel passage Ø 25 mm	3332 0503
Insert for funnel passage Ø 20 mm	3332 0506
Insert for funnel passage Ø 16 mm	3332 0509
Insert for funnel passage Ø 12 mm	3332 0512
Hook-in plates (stainless steel) amending the division ratio	3331 0530
Collecting pan (PVC) 2 liter	Dimensions with handle: 275x133x108 mm 3110 0050
Collecting pan (stainless steel) 2 liter	Dimensions with handle: 275x133x108 mm 3351 0500
Collecting pan (stainless steel) 3,5 liter	Dimensions with handle: 385x133x108 mm 3331 9015
Sample pan for flow (stainless steel)	Dimensions with handle: 345x137x108 mm 1740 0081
Side funnel for model Vario 2H	3321 4020
Agitator for non-free-flowing products	1745 0065
<b>Only for Sample Divider 4-8:</b>	
Collecting pan (stainless steel) 2 liter	Dimensions with handle: 211x133x108 mm 3331 9010

The agitator for non-free-flowing products (e.g. moist maize) consists of an electric motor, a shaft for power transmission and a wire that rotates within the funnel. Rotation allows the agitator to effectively prevent the filling funnel from blocking. (Item no. 1745 0065)

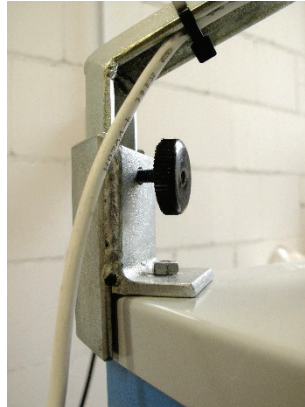

Figure 7: Agitator and fixing the holder to the cover

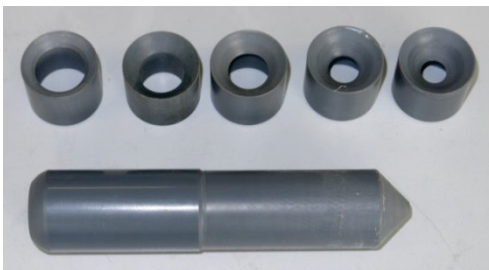

Figure 8: Inserts and installation of the inserts



Collecting pan (stainless steel) 3.5 liter  
(Item no. 3331 9015)

Collecting pan (stainless steel) 2.0 liter, only for  
**Vario 4-8** (Item no. 3331 9010)

Figure 9: Collecting pan (stainless steel)

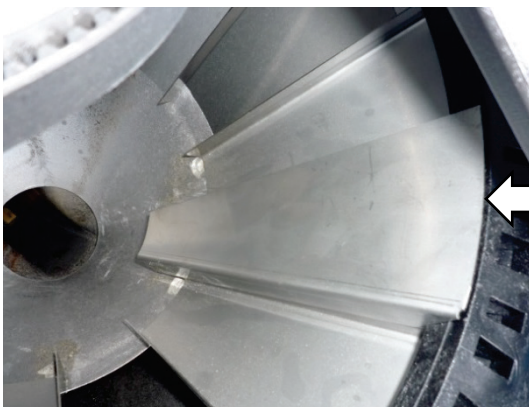

Figure 11: Hook-in plates amending the division ratio  
(Item no. 3331 0530)

Figure 10: Hook-in plates, attached



## 12 Emergency



⇒ In case of an emergency, disconnect the Sample Divider from the electrical power supply.

## 13 Dismantling and disposal



Dismantling and disposal is only allowed to be performed by **skilled personnel**.



### DANGER



#### Touching live parts can be fatal!

It is essential to comply with the switch-off procedure prior to cleaning, maintenance or repair work! (see **chapter 2.8**)



#### Special waste

Oil, cleaning agents, contaminated cleaning tools (brush, rags, etc.) must be disposed of according to the local regulations and in accordance with the notes in the manufacturers' safety data sheets.



Disposal with the household garbage is forbidden! The **Vario** Sample Divider must be disposed of in accordance with the applicable local environmental regulations (Directive for electrical and electronic equipment waste WEEE 2012/19/EU).

