

Gas Chromatograph Mass Spectrometer

# GCMS-TQ8050

*UFMS*  
ULTRA FAST MASS SPECTROMETRY



# GCMS-TQ8050 *with Smart Abilities*





POWER 

READY 

FAILURE 

 SHIMADZU

**GCMS-TQ8050**  
GAS CHROMATOGRAPH MASS SPECTROMETER

# Enhanced Sensitivity Leads to New GC-MS/MS Possibilities

The GCMS-TQ8050 features a new highly efficient detector and three noise-reduction technologies that enable femtogram-level quantitative analysis.

Also, the increased instrument robustness and safety provide dramatically improved reliability for ultra-trace analysis.

## Enhanced Sensitivity

A new detector with better amplification performance maximizes the benefits of the OFF-AXIS Ion Optics, which offers both high ion transmission performance and outstanding noise elimination performance. These state-of-the-art technologies enable the system to reliably detect ultra-trace quantities of ions, down to the femtogram level, achieving the world's highest\* sensitivity levels.

\* As of August 2016, according to a Shimadzu survey.

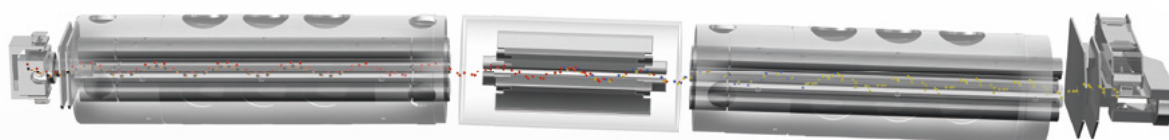

## Durable Hardware

In addition to high sensitivity, the system offers highly robust performance. The contamination-resistant ion source and the new detector with over five times longer service life ensure reliable, long-term analysis. An oil-free pump that can be operated for three years without maintenance is also available.

## Superior Performance

A new turbomolecular pump with higher evacuation performance achieves a superior vacuum state in the MS unit. This results in higher sensitivity and stability and helps improve analysis accuracy for ultra-trace concentration levels.

Using the ultra-fast analysis technology (UFsweeper) offered in existing models, the system can simultaneously analyze samples using multiple modes, such as high-speed scanning and scan/MRM modes.

## Reliable Operation

The Smart MRM technology that optimizes sensitivity helps accurately create methods for ultra-trace analysis and ensures high sensitivity for MRM measurements. In addition, the enhanced accuracy control function provided by LabSolutions Insight software improves the reliability of analyzing data acquired from simultaneous multicomponent analysis of ultra-trace components.

# Enhanced Sensitivity

The new GCMS-TQ8050 triple quadrupole mass spectrometer has been created based on continuously advancing Smart technologies that go beyond what was previously possible. The resulting exceptional analytical sensitivity and robustness increase the value of solutions and open the door to new applications.

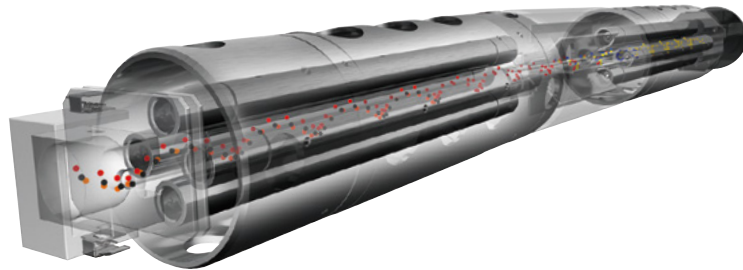

The newly designed high-sensitivity detector offers excellent reliability even for samples with femtogram-level concentrations of trace components, achieving sub-femtogram IDL\* levels.

\*IDL: Instrument Detection Limit

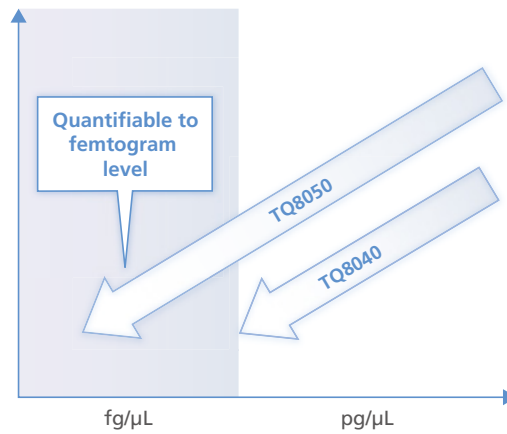
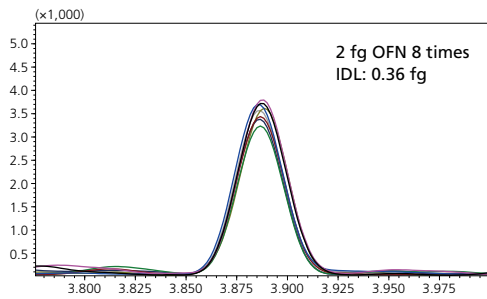

The superior data stability with the GCMS-TQ8050 provides sensitivity that rivals high-resolution GCMS analysis. This powerful new analytical instrument reliably identifies peaks even for trace quantities of dioxins and other substances previously considered difficult to analyze using a quadrupole GCMS system.

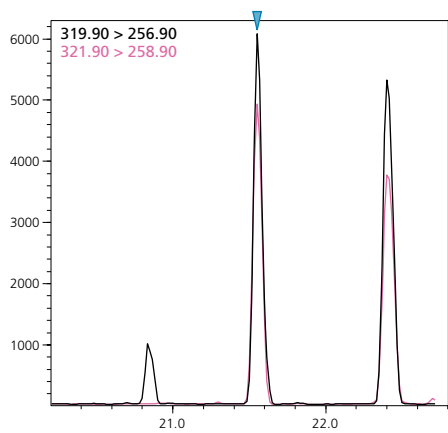

Mass chromatogram of 2,3,7,8-TeCDD (50 fg/μL)

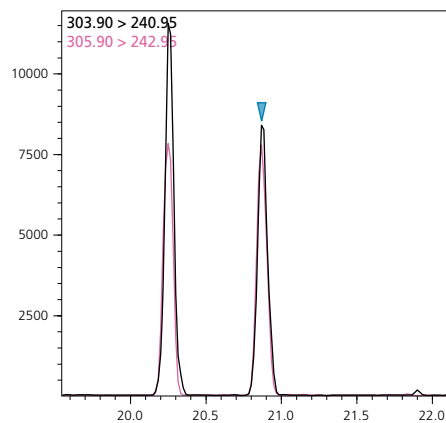

Mass chromatogram of 2,3,7,8-TeCDF (50 fg/μL)

# UF-Transmission

## High-Sensitivity Detector

The GCMS-TQ8050 detects peaks more reliably than previous models, even for substances with fewer ions reaching the detector. That means it can reliably analyze femtogram-level concentrations with fewer ions.

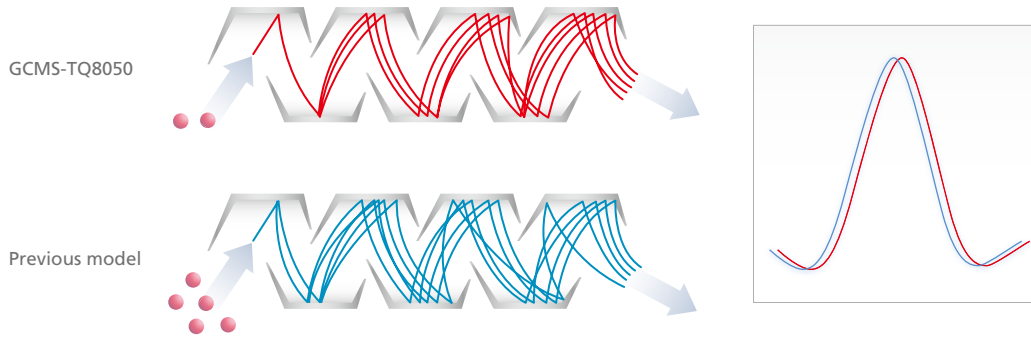

## OFF-AXIS Ion Optics

The OFF-AXIS Ion Optics eliminate noises such as metastable He ions without compromising sensitivity.

## Shielded Detector

Noise from outside the detector was reduced by installing a shield in the secondary electron multiplier.

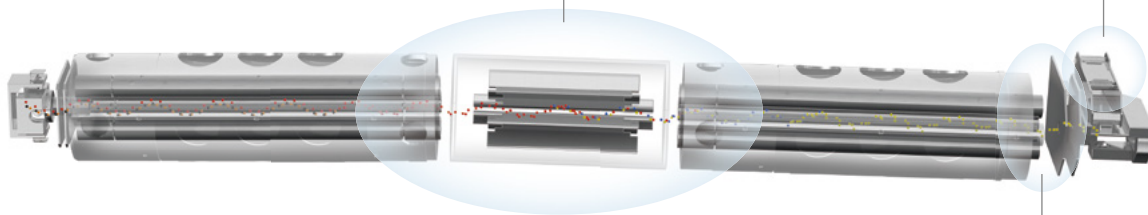

## Overdrive Lens

Installing two lenses (overdrive lenses) in front of the electron multiplier reduces random noise from helium or argon and improves S/N. Applying voltage to the lenses improves S/N levels by reducing noise near the lenses and helping to focus the ions that pass through the mass filter (Patent No. US6737644).

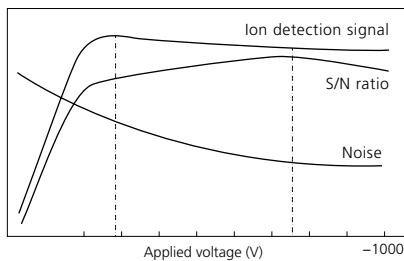

Relationship between voltage applied to overdrive lenses and S/N

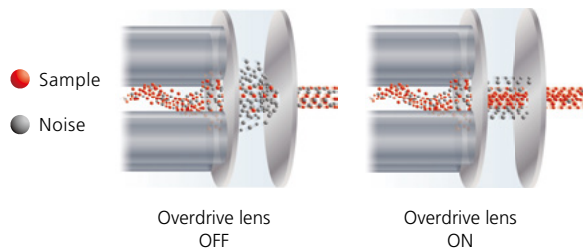

Noise reduction due to overdrive lenses

# Durable Hardware

Reduces maintenance frequency and costs for long-term use.

## Highly Sensitive and Stable Ion Source

The effect of the filament's electric potential on the ion source is reduced by placing more distance between the filament and ion source box. In addition, a shield blocks out radiant heat generated from the filament to ensure the ion source box temperature remains uniform. Since this prevents any active spots within the ion source, it provides higher sensitivity for analysis. (Patent: US7939810)

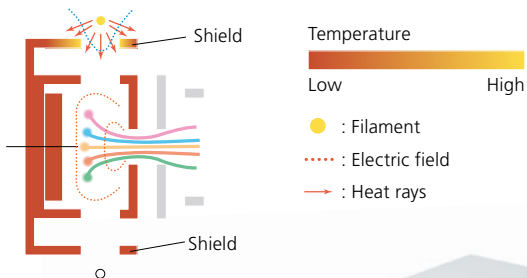

## Long-Life Detector

Exhaustive efforts to reduce detector loads during analysis significantly increase the detector's service life. Consequently, the instrument needs to be maintained much less frequently, which also means less downtime.

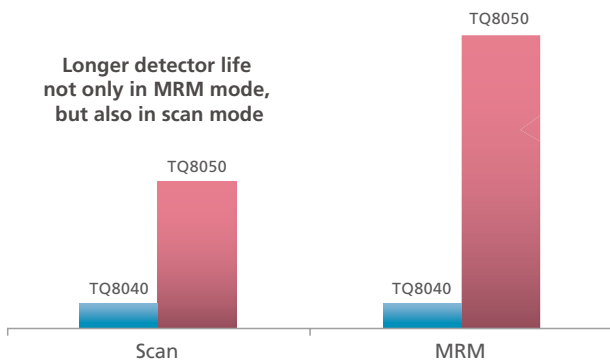

## Oil-Free Pump (Optional)

The rotary pump can be replaced with an oil-free pump, which requires no maintenance for three years. This auxiliary vacuum pump not only maintains an oil-free environment inside the vacuum lines, it also eliminates the tedious and time-consuming tasks of replacing and disposing of the oil.

Clean exhaust due to dry method using no oil in the pump chambers

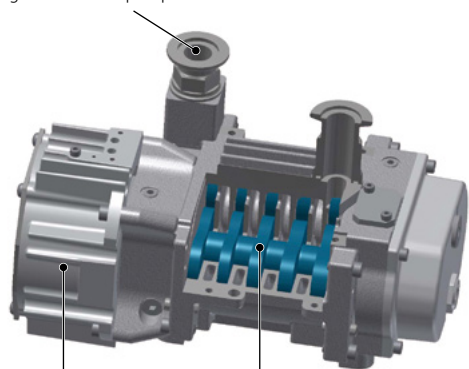

Air cooling method using no cooling water

Long life with no performance deterioration

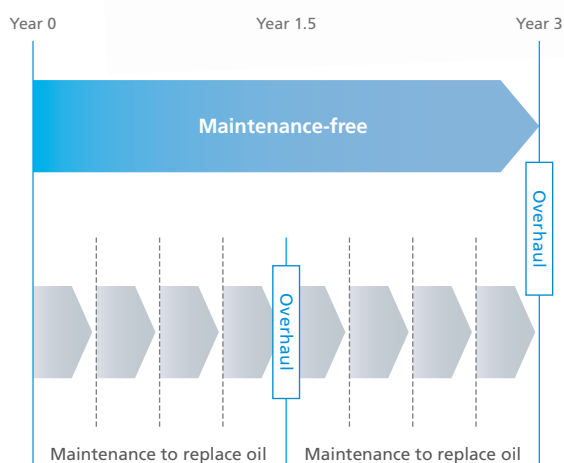



# Superior Performance

The new turbomolecular pump and high-efficiency collision cell enable a variety of high-sensitivity analyses.

## ■ New Large-Capacity Differential Vacuum System

A more stable vacuum system was achieved by using a new turbomolecular pump that offers higher evacuation efficiency. Consequently, it is able to maintain a high vacuum level even during MRM analysis with a collision gas introduced, which enables highly accurate trace analysis.

## ■ High-Efficiency Collision Cell UFsweeper

Shimadzu's proprietary UFsweeper technology achieves high-speed MRM analysis at speeds up to 800 transitions per second. It sweeps residual ions from the collision cell to provide high-efficiency CID and fast ion transport. Rapid ion removal minimizes cross-talk and enables trace analysis (patent pending).

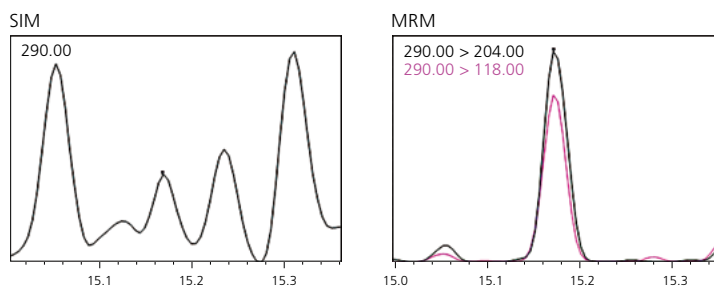

Analysis of residual pesticides (Isoprothiolane 1 pg/μL)

## ■ Sensitivity and Repeatability in Single GC/MS Mode

The high-efficiency ion source provides the foundation of an ion generation and transmission system, which creates and then delivers ions to the detector, resulting in a GC/MS with the maximum possible sensitivity and repeatability. These features are not realized just for MRM measurements by GC-MS/MS, but also for scan and SIM measurements in single quadrupole modes, even with the most reactive compounds.

Q1 with post-rod achieves outstanding ion transfer efficiency

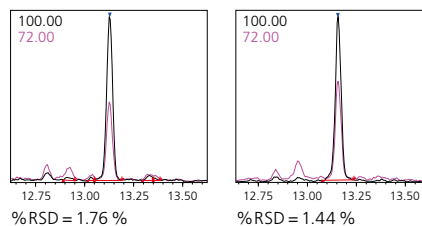
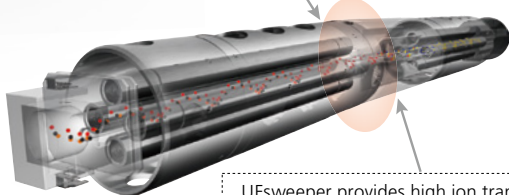

Thiobencarb 5 pg/μL  
Left: GCMS-QP2020, Right: GCMS-TQ8050  
(for RSD determination, n = 5)

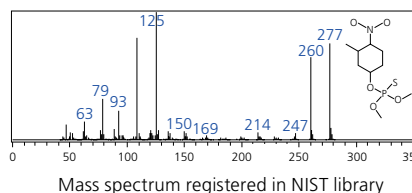
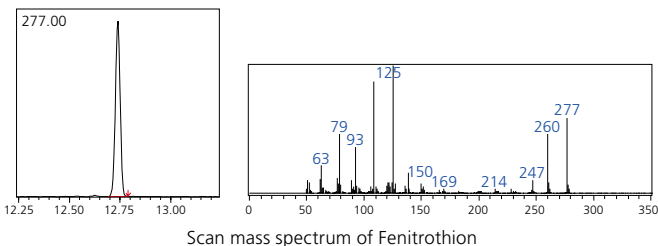

# Reliable Operation

High Accuracy from Method Creation to Data Analysis

## Smart MRM

The Smart MRM function automatically creates methods with measurement times optimized for each component. When creating methods for simultaneous multicomponent analysis, the complicated process of configuring measurement parameters made it difficult to prepare appropriate methods. By using the Smart MRM function, however, it is possible to automatically create methods with which data is acquired only during the elution time of the target components. In addition to MRM methods, SIM methods can also be created.

Method	Type	Acq. Mode	Method No.	Transition Name (C)	Scan Value 1	Scan	Type	MS1	MS2	Type	MS1	MS2	Type	MS1	MS2
1	Target	MRM	1	Aldicarb mg	887	0 - 100 - 0	T	118.1x100.1	8	100.00	Ref.1	118.1x68.0	8	100.00	
2	Target	MRM	1	DOP	1052	100 - 80 - 1	F	151.1x100.0	0	100.00	Ref.1	151.1x77.0	8	100.00	
3	Target	MRM	1	Atrazine mg	1153	0 - 100 - 0	T	80.0x40.0	0	100.00	Ref.1	80.0x40.0	0	100.00	
4	Target	MRM	1	Chlorpyrifos mg	1164	0 - 100 - 0	T	107.0x100.0	14	100.00	Ref.1	107.0x70.0	8	100.00	
5	Target	MRM	1	Imidacloprid	1201	100.04 - 66 - 1	T	88.0x71.0	8	100.00	Ref.1	88.0x54.0	8	100.00	
6	Target	MRM	1	Methomathion	1240	100.00 - 87 - 8	T	141.0x60.0	8	100.00	Ref.1	141.0x100.0	4	100.00	
7	Target	MRM	1	Dichlorvos	1340	80 - 77 - 1	F	188.0x60.0	14	100.00	Ref.1	188.0x100.0	14	100.00	
8	Target	MRM	1	Hexachloro	1380	0 - 100 - 0	T	148.1x71.1	8	100.00	Ref.1	148.1x100.1	8	100.00	
9	Target	MRM	1	Azinphos	1390	80 - 77 - 0	T	128.1x68.0	8	100.00	Ref.1	128.1x71.1	8	100.00	
10	Target	MRM	1	Disulfoton	1548	1104 - 68 - 8	T	170.0x100.0	24	100.00	Ref.1	170.0x100.0	14	100.00	
11	Target	MRM	1	SPIC	1550	1104 - 68 - 4	T	188.1x100.1	41	100.00	Ref.1	188.1x60.0	12	100.00	
12	Target	MRM	1	Baygon	1555	80 - 60 - 4	T	154.1x100.1	40	100.00	Ref.1	154.1x71.1	44	100.00	

## Smart MRM



## Smart Database

Information about optimal transitions is preregistered in the Smart Database. That means Smart MRM can be used to create optimized methods without having to evaluate analytical conditions. The Smart Database provides powerful support for performing highly reliable analysis.

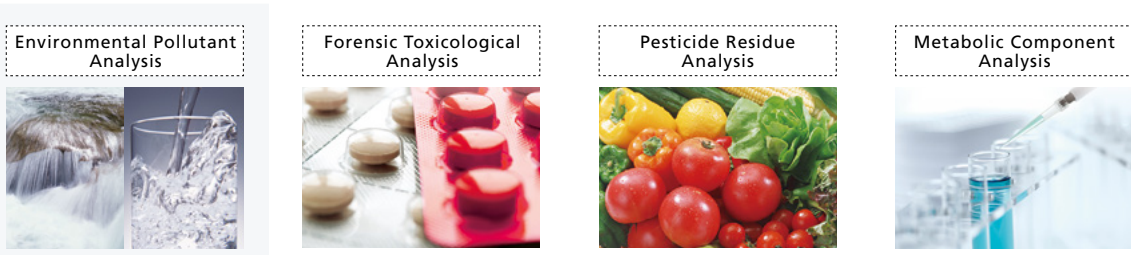

In particular, the "Smart Environmental Database" is extremely useful for analysis of environmental pollutants, which require trace analysis. Not only are MRM information and stable isotope labeled compounds (IS) for target analysis components registered in the Smart Environmental Database, but also the optimal columns for separating each compound are set, so trace analysis can be smoothly performed without having to set the conditions for each compound.

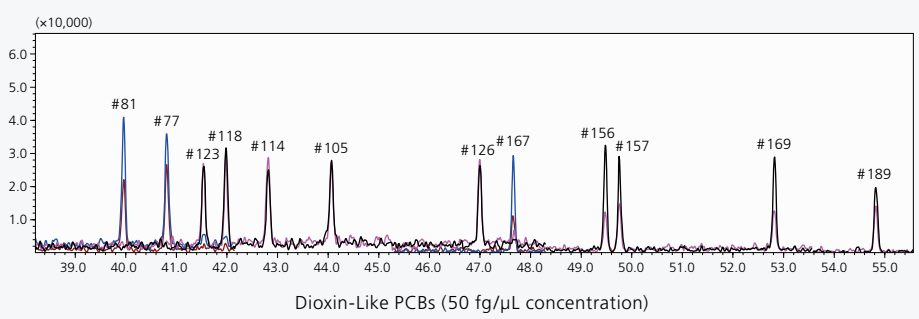

# Solutions for Analyzing Ultra-Trace Hazardous Substances in Foods and the Environment

Dioxins and other persistent organic pollutants (POPs) in foods and the environment are normally detected at femtogram-level concentrations, which requires high sensitivity and high quantitative accuracy. Because the new detector used in the GCMS-TQ8050 can detect much lower quantities of ions than previous models, it is able to analyze femtogram-level concentrations of hazardous substances with high sensitivity. Also, the detector's improved sensitivity

provides high accuracy for quantitative analysis of femtogram-level concentrations of hazardous substances. Furthermore, sensitivity and quantitative accuracy were enhanced by making improvements to the input of ions into the detector. Therefore, the GCMS-TQ8050 can be used to analyze ultra-trace concentrations of hazardous substances, which were difficult to analyze using previous GC-MS/MS systems.

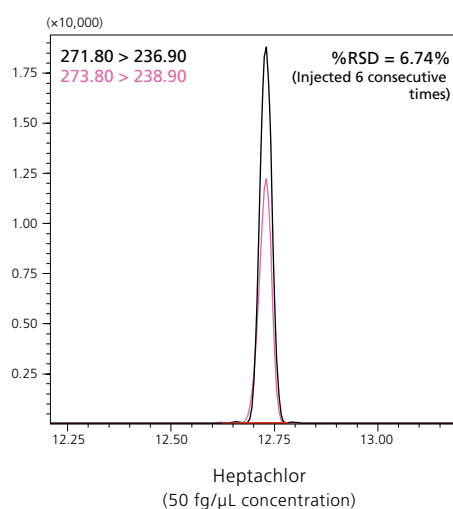
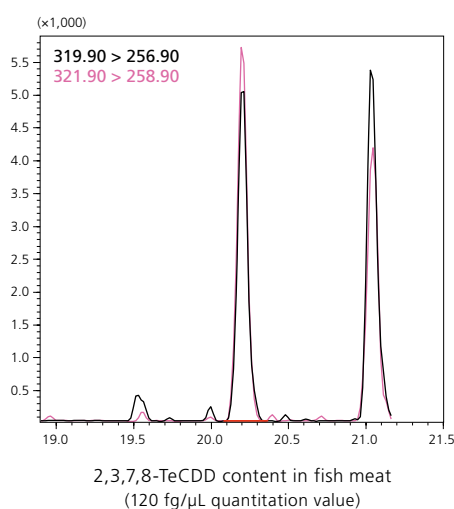

A type of female hormone, estrogen persists in the environment at low concentrations as an endocrine disruptor, which requires high sensitivity for analysis. To analyze estrogen, it is first derivatized and then a GC/NCI-MS system is used to selectively analyze compounds with high electron affinity. The GCMS-TQ8050 proves its worth in ultra-trace

analysis using not only EI, but CI and NCI ionization methods as well. In particular, the GCMS-TQ8050 can analyze femtogram-level concentrations of estradiol, which is one type of estrogen, with high sensitivity and accuracy using NCI. Therefore, it eliminates the previously required step of first concentrating samples.

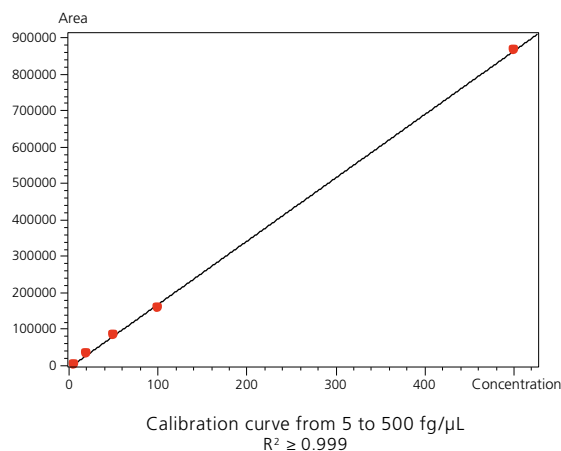
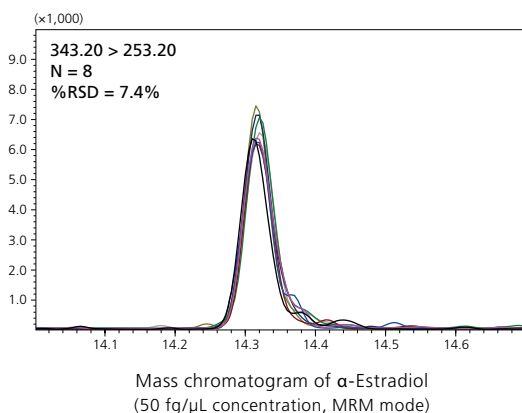

# LabSolutions Insight

Smart Processing of Hundreds of Data Files

## Multi-analyte Data Review

With LabSolutions Insight software, quantitative results for a complete series of data files can be displayed side-by-side for comparison and QC review. All of the chromatograms for a selected target compound can be displayed simultaneously, making it easy to review the detected peaks and confirm the quantitative results. Color-coded QA/QC flags quickly identify any outliers that require further examination.

## Color-coded Quantitative Flags

In LabSolutions Insight, quantitative results can be compared to established criteria, and any outliers are color-coded for easy identification and further review. Five color-coded criteria levels can be defined, making it easy to determine which data points are outliers, and which specific QC criteria were not met. Any changes made to calibration curves or manual peak integration are immediately reflected in the color-coded flags.

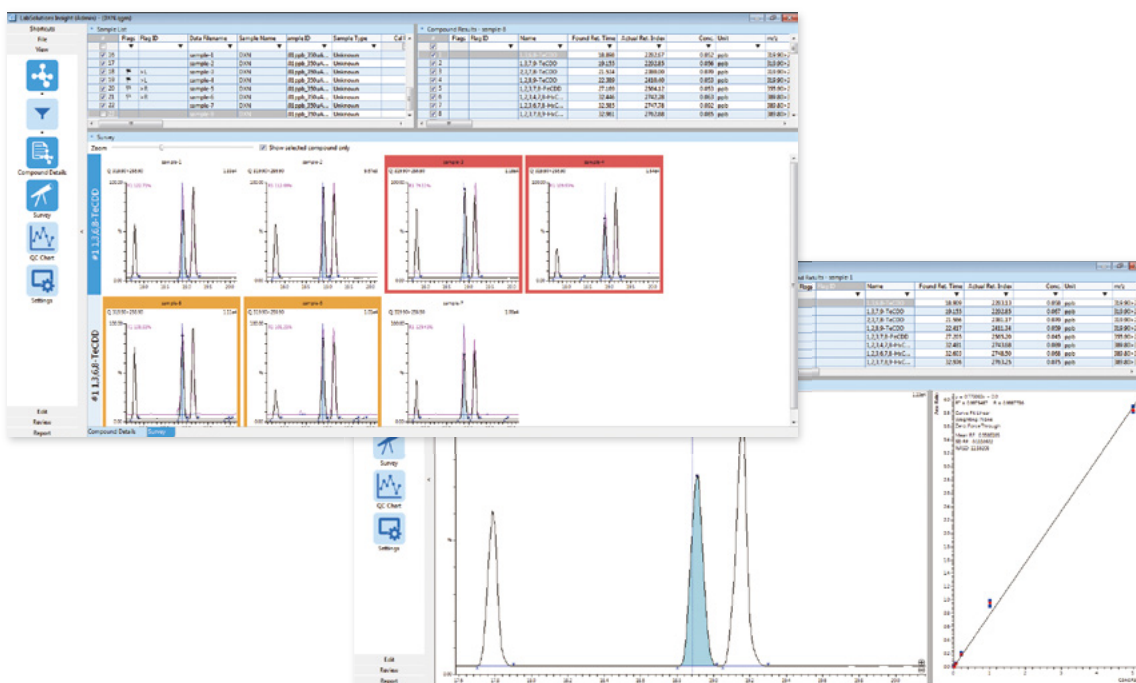

## Status Review Function

This function can be used to specify the status of all compounds and samples for their management. By specifying a status, the progress of data analysis work can be accurately recorded and reported.

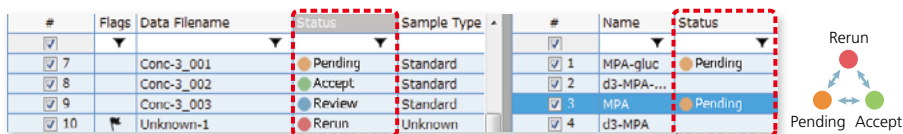

## ■ Enhanced Accuracy Controls

Accuracy control results, such as retention time differences, calibration curve linearity and peak shapes (tailing), can be assessed visually.

In addition, the QC chart function in LabSolutions Insight allows visual confirmation of variations in target compounds across multiple data sets. This is useful when evaluating variations in internal standard substances between samples, for example.

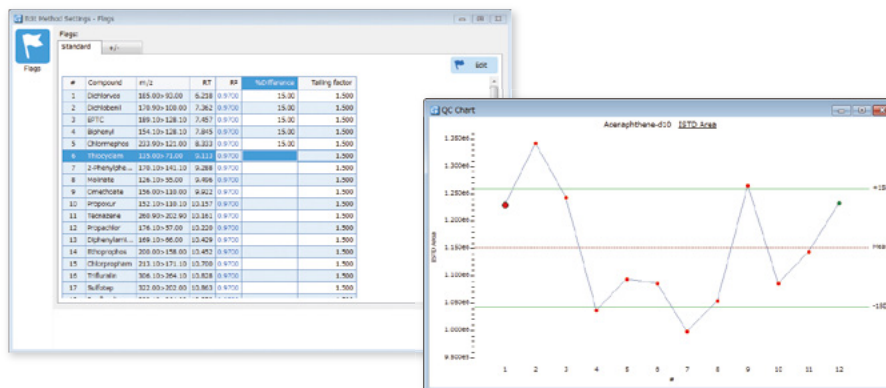

## ■ System Configurations Using Multiple Client Computers

Data acquired from multiple systems can be reviewed or confirmed using client computers connected via a LAN or other network. If multiple systems are used, data obtained from each system can be reviewed from any client computer. Even in the case of multiple analysts using the same system, the ability to separate analytical work from measurement work improves work efficiency.

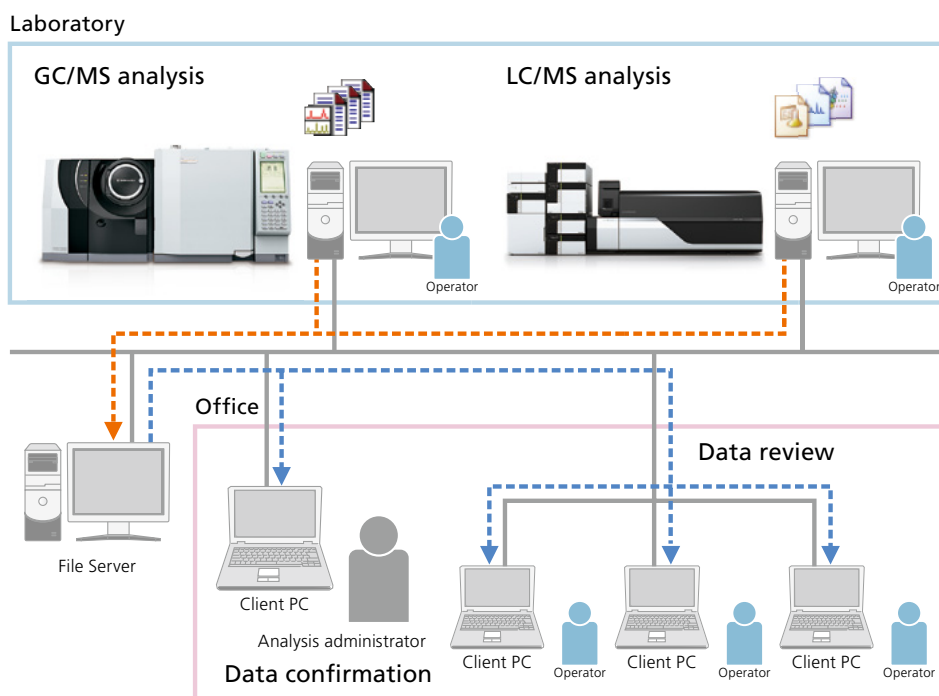

File management on a file server is recommended for systems with more than five users.

# Wide Variety of Optional Products for Supporting Trace Analysis

## ■ Chemical Ionization and Negative Chemical Ionization

In addition to commonly-used electron ionization (EI), both chemical ionization (CI) and negative chemical ionization (NCI) are available for the GCMS-TQ8050. The CI mode is a "soft ionization" technique, used to detect many compounds not possible by EI, and is suited for confirmation of molecular weight. The NCI mode can be used to detect functional groups having a high electron affinity such as halogens. Any of three types of reagent gases (methane, isobutane, or ammonia) can be used.

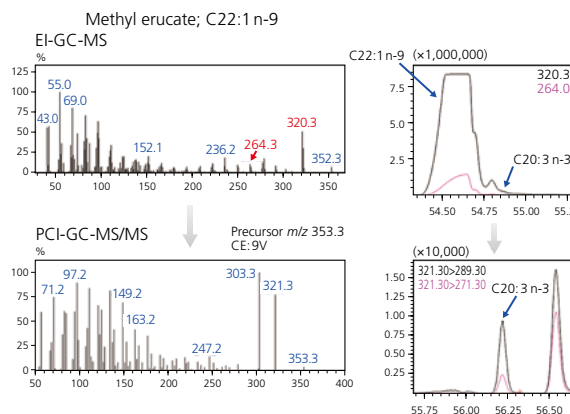

## ■ HS-20 Headspace Sampler

In combination with the HS-20 headspace sampler, the GCMS-TQ8050 can perform quantitative analysis for impurities in pharmaceuticals. In particular for highly toxic compounds for which trace determination is required, accurate quantitative analysis can be carried out down to low concentrations with MRM analysis using the GCMS-TQ8050.



## ■ AOC-6000 Multifunctional Autosampler

For target substances that require femtogram-level trace analysis, it is difficult to perform sample preparation, such as dilution and adding internal standards, due to the high toxicity. The AOC-6000 features a robotic tool changer (RTC) function that performs all steps from adding the internal standard to diluting samples automatically. Using this autosampler allows the user to perform everything from sample preparation to analysis as a continuous process, which can dramatically increase analytical throughput.



Internal standard

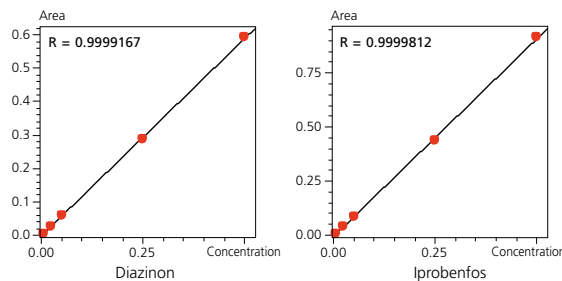
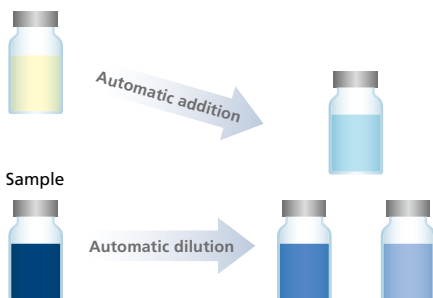

Calibration curve prepared from 1 to 100 pg/μL using automatic dilution function

# High-Quality Consumables Comprising the GC/MS Flow Path

The sensitivity and stability of measurements with GC/MS depend on how much adsorption and other losses can be suppressed in the flow line from sample injection to the detector. The flow lines in the GCMS-QP series and the TQ series consist of high-quality, highly reliable consumable parts, so even trace-quantity concentrations can be detected with high sensitivity and favorable repeatability.

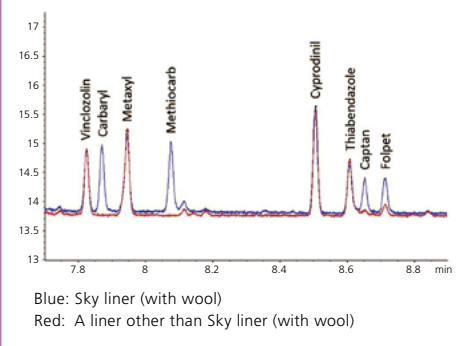
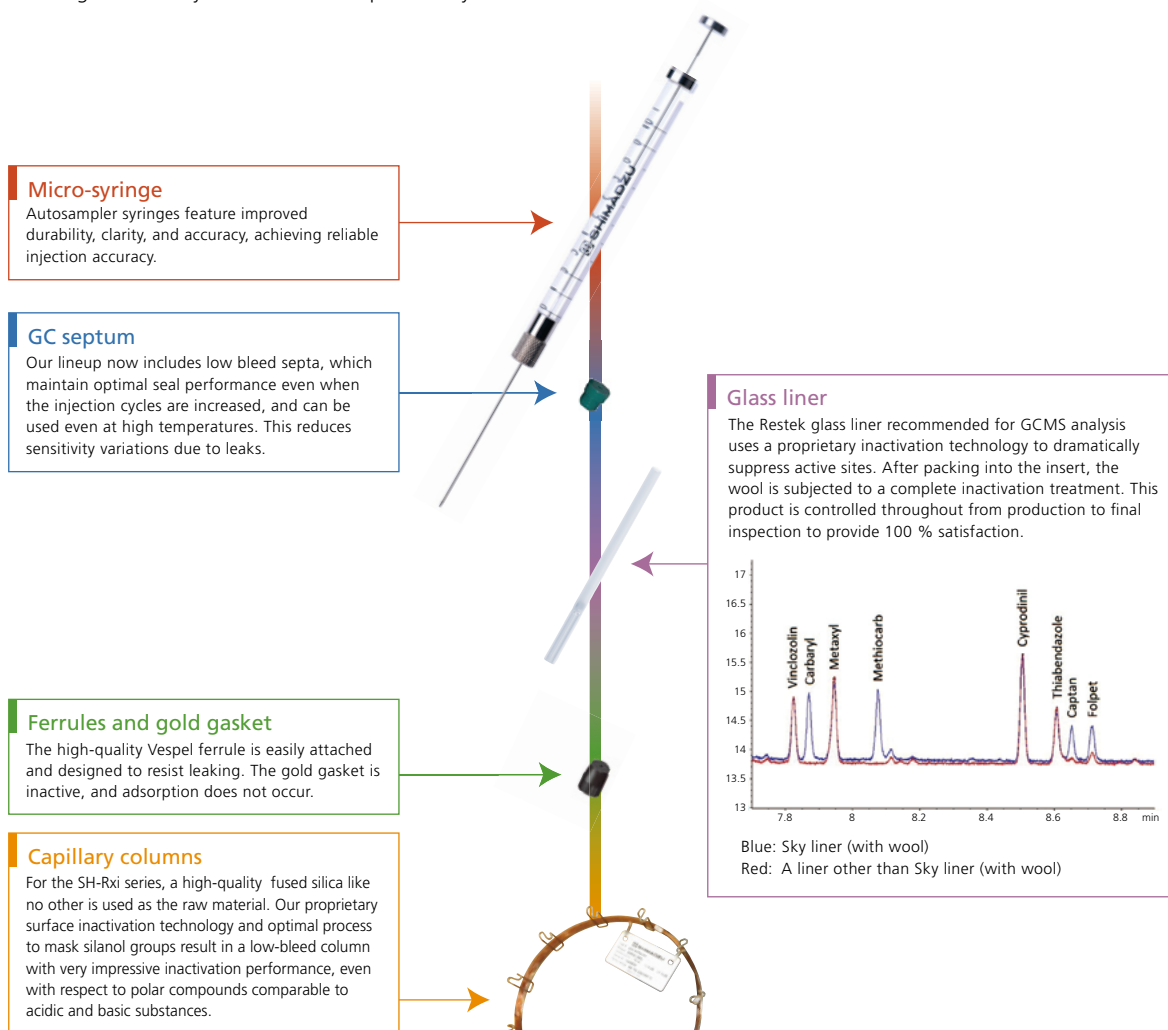

An ultra-low-bleed SH-Rxi column, compared to columns of other manufacturers, can improve sensitivity and accuracy for low-concentration samples.

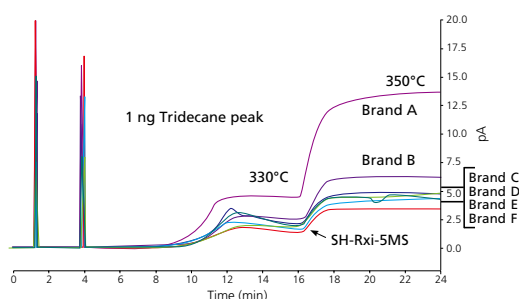



Shimadzu Corporation

[www.shimadzu.com/an/](http://www.shimadzu.com/an/)

**For Research Use Only. Not for use in diagnostic procedures.**

This publication may contain references to products that are not available in your country. Please contact us to check the availability of these products in your country.

Company names, product/service names and logos used in this publication are trademarks and trade names of Shimadzu Corporation or its affiliates, whether or not they are used with trademark symbol "TM" or "®". Third-party trademarks and trade names may be used in this publication to refer to either the entities or their products/services. Shimadzu disclaims any proprietary interest in trademarks and trade names other than its own.

The contents of this publication are provided to you "as is" without warranty of any kind, and are subject to change without notice. Shimadzu does not assume any responsibility or liability for any damage, whether direct or indirect, relating to the use of this publication.