

**OLYMPUS**<sup>®</sup>

Your Vision, Our Future

Culture Microscope

**CKX53**

CKX3 Series

The Cell Culture Laboratory Solution

**NEW**





# Improved Imaging and Usability Facilitates Cell Cultivation

With improved image quality and easy handling, the Olympus CKX53 delivers stable performance and a more efficient cell culture process for a variety of cell culture needs including live cell observation, cell sampling and handling, image capture, and fluorescence observation.

## Live Cell Observation

Acquire clear, reproducible, and high contrast images with a wide visual field, made possible by the CKX53's long-life LED and iPC system. Additionally, the newly developed inversion contrast (IVC) technique provides clear three-dimensional views.

## Cell Sampling and Handling

CKX53 offers easier and more efficient cell sampling and handling in a clean bench environment, because of its small size and lightweight design. The user-oriented design and simple operation of the holder and manual stage maximize performance and usability.

## Image Capture

Equipped with a standardized camera port, the CKX53 can be optionally paired with an Olympus camera, allowing users to quickly obtain clear images in brightfield illumination, phase contrast, newly developed inversion contrast, and fluorescence imaging modes.

## Fluorescence Observation

During fluorescence observation with the CKX53, a wide range of fluorescence dyes can be used by changing the mirror unit. With the increased filtering ability of the fluorescence mirror units, high contrast fluorescence images with a high S/N ratio can be reliably obtained even when fluorescence is relatively weak. Additionally, with the aid of the CKX53's 100W mercury lamp, clear and bright fluorescence observation is enabled.





# Live Cell Observations

## Fast and Efficient Cell Observation with the integrated Phase Contrast (iPC) System

The high contrast achieved by the CKX53 iPC system quickly provides a clear view without needing to change the ring slit from the 4X to 40X objective. Performing simplified and efficient cell observation, for faster cell culture operations is made possible.

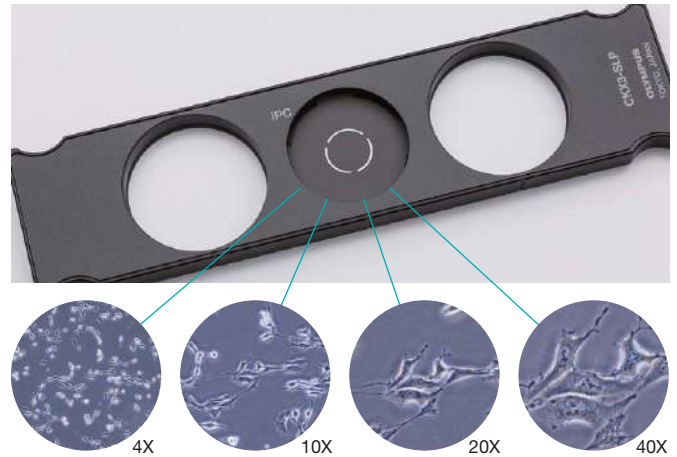

## Clear View Empowered by Long-Life LED Light Illumination

Lasting longer than halogen bulbs, the energy-saving LED light source of the CKX53 delivers reliable color reproducibility as well as a uniform and clear image over the whole visual field with a field number (FN) of 22. The energy-saving performance of CKX53 guarantees a clear and stable view.

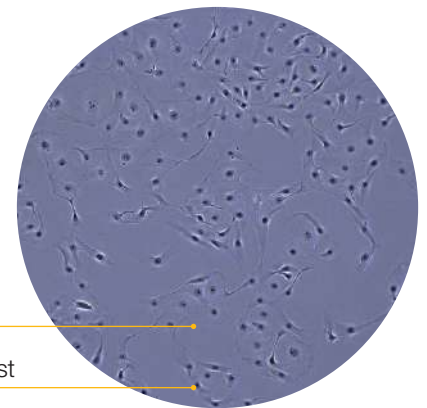

Clear view over the whole visual field

Phase contrast observation with high contrast



## Wide and Clear View with the 2X Objective

The ring slit for the PLN2X objective, CKX-SLPAS, has a 22 mm field of view of 11 mm diameter. As a result, observation using the objective is perfect for efficient screening of the desired cells, allowing a faster cell culture process. Additionally, the 2X objective provides noticeably higher contrast, allowing even transparent objects in the sample to be clearly identified.

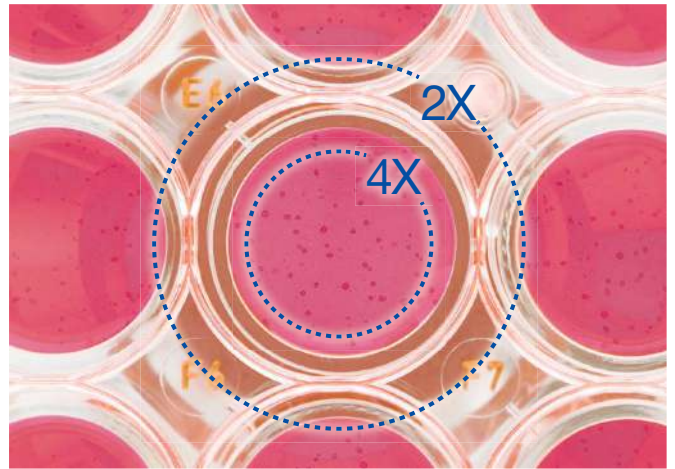

When viewing a 96-well plate, the wide visual field allows all the cells in a well to be observed without moving the stage.

## Experience 3D Views Driven by the “Inversion Contrast” (IVC) Technique

With the use of this newly-developed IVC technique in CKX53, where the depth of field is narrower than that of the phase contrast, clear three-dimensional images can be obtained for objects of any shape, even transparent ones. In addition, IVC observation provides clear views without halos or directional shadows, preserving the integrity of object details during observation.

\*10X objectives (PLCN10X, CACHN10XIPC) are lined up for this new IVC observation.

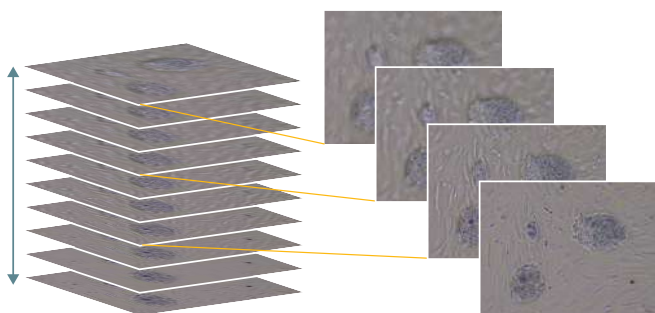
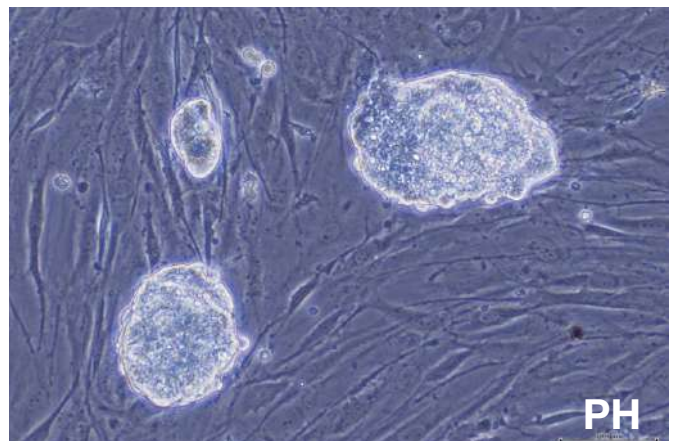
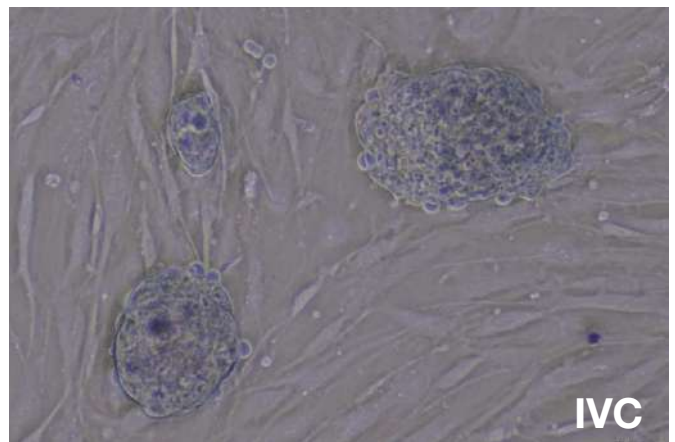

Reference: Y. Suzuki et al., Method for observing phase objects without halos or directional shadows. Opt Lett. 2015; 40(5): 812-5



# User-Oriented Design for Efficient Cell Sampling and Handling

## Smooth Cell Observations in Sterile Conditions

With the hood kept down, CKX53 fits perfectly in a clean bench environment, allowing cell handling under completely sterile conditions. With its UV-resistant coating, CKX53 can also be left in the clean bench during the UV light sterilization process. Compared with previous CKX models, CKX53 weighs approximately 7kg and has a smaller base footprint. It can easily be moved with just one hand, using the neck of the observation tube for lifting as well as the sliding pad at the base of the microscope.



## Easy Cell Sampling in a Clean Bench Environment

The shorter distance between the view point and the optical axis/focus knob on CKX53 offers natural hand positioning and makes focusing and cell sampling easier. Additionally, with full LED lighting available from the moment CKX53 is turned on, operation is less of a burden to the user, and cell sampling and handling can be finished in a shorter period of time.



## Ergonomic Advantages for Easy and Smooth Operation

Whether observing in a standing or seated position, the 45-degree optical access and the placement of the butterfly-shaped observation tube against the stage allows for ergonomic cell observation. Sterile work can be quickly started and finished, allowing cells to be returned to the incubator in a shorter time.

Additionally, the power switch is placed directly under the observation tube located along the stage. The operating components such as the power switch and the knob for switching the light path are placed close together to enhance the operability of the CKX53.



## Easy Handling of Any Type of Cell Culture Containers

Using the universal holder with the CKX53, it is possible to easily view cells that were cultured in a variety of containers, such as dishes, microplates, and flasks. Also, when the optional holder is attached, a maximum of three 35 mm dishes can be accommodated on the stage.

Microplates can be handled without a holder, and the well “address” of the microplate can be identified quickly using the grid for each well position on the CKX3-MVR manual stage. When viewing a 96-well plate, each 90-degree rotation of the stage knob moves the well position one at a time, allowing intuitive handling of the microplate during observation.



## More Comprehensive Observation for a Multi-Layer Tissue Flask

Due to the width of CKX53, when the condenser is detached it is possible to view containers such as multi-layer tissue flasks up to 190 mm in height. In addition the objectives can be lifted up to 19 mm, allowing cell observation of the bottom two layers of a multi-layer tissue flask in combination with the UPLFLN4XIPC objective.



## Flexibility of Using Different Containers

The arm of the holders can easily be lifted up for manual positioning of the culture containers. Additionally, the stage can be expanded up to 70 mm to the left and right for greater handling flexibility.

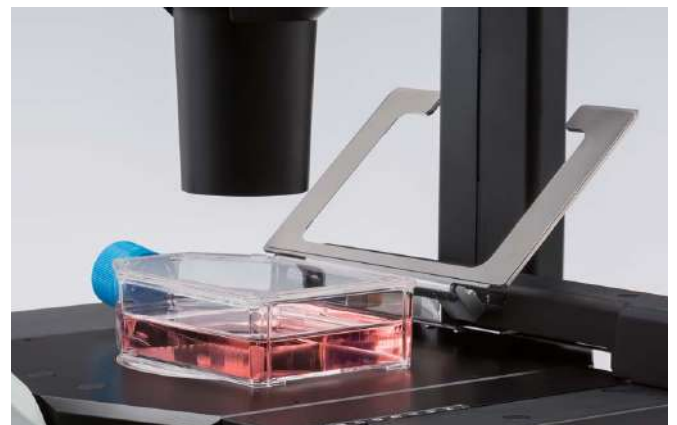

# Fluorescence Observation

## Clear Views with a Wide Range of Fluorescence Dyes

With the CKX53 standard fluorescence set, even weak fluorescence signal can be viewed clearly with the aid of the integrated 100W mercury lamp (U-LH100HG). The same type of mirror unit as those of IX3 and BX3 can be set at three slots of the mirror unit slider. Also, the same quality of performance in fluorescence observation as top of the line inverted microscopes can be obtained for wide range of fluorescence dyes according to the user's needs. Compared to previous CKX models, the increased filtering ability of the fluorescence mirror units produces images at higher contrast.

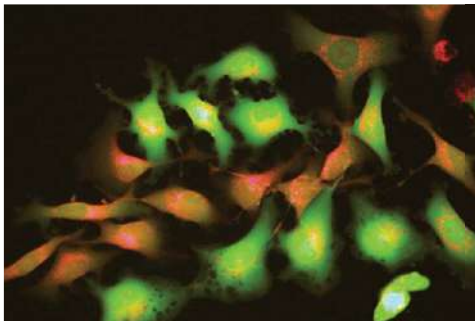

## High Contrast under Bright Conditions

The "Umbra Shield" is designed specifically for CKX53 fluorescence observation. It efficiently blocks out room light, enhances the contrast of fluorescence, and enables clear fluorescence observation even under bright conditions. When using phase contrast, the Umbra Shield can be lifted up to pass light through to the sample.

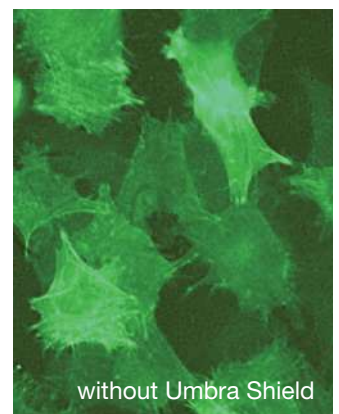
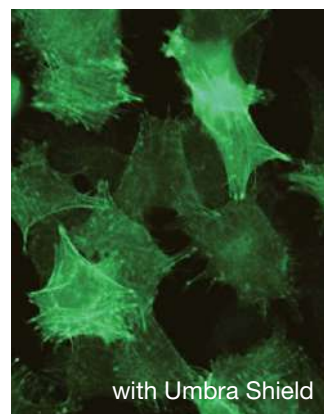



# Optional Products on Cell Culture Process

## Instantly Ready for Clear Image Capturing

The CKX53 comes standard with a camera port. When used with the DP22, its software has a function called "Cell Culture mode" that can capture the appropriate color for cell culture samples, so the CKX53 instantly captures clear high quality images. For further versatility, other cameras with C-type lens mounts can also be used with the CKX53.



## Efficient Cell Culture Flow Possible with Cell Counter model R1

To accelerate the cell culture process, the cell counter offers easy and smooth operation when concomitantly used with CKX53 for quick live imaging and accurate cell count of cultured cells. Efficient flow of cell observation and counting can be accomplished with this Olympus lineup for cell culture.

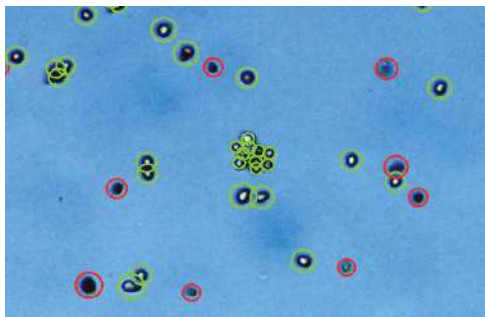

○:Live cells ○:Dead cells



DP22 and Cell Counter model R1 are for research use only.

# CKX53 Configuration

## Four Upgradeable Base Configurations

### Brightfield

This package features brightfield objectives (4X and 10X) and is suitable for observing stained samples e.g. protoplasts, other plant, plankton or similar specimen.



### Phase Contrast Entry

This package features phase contrast objectives (4X, 10X, and 20X) and is suitable for observing the condition and activity of transparent live cells.



### Phase Contrast Standard

This package features phase contrast objectives (4X, 10X, 20X, and 40X) and the manual stage (CKX3-MVR). It is suitable not only for observing the condition and activity of transparent live cells, but also for observing detailed structures within the cells.



### Fluorescence

This package is suitable for checking fluorescence. It features a mercury lamp housing (U-LH100HG) and fluorescent illuminator, as well as phase contrast objectives (4X, 10X, 20X, and 40X) and the manual stage (CKX3-MVR).



# CKX53 System Diagram

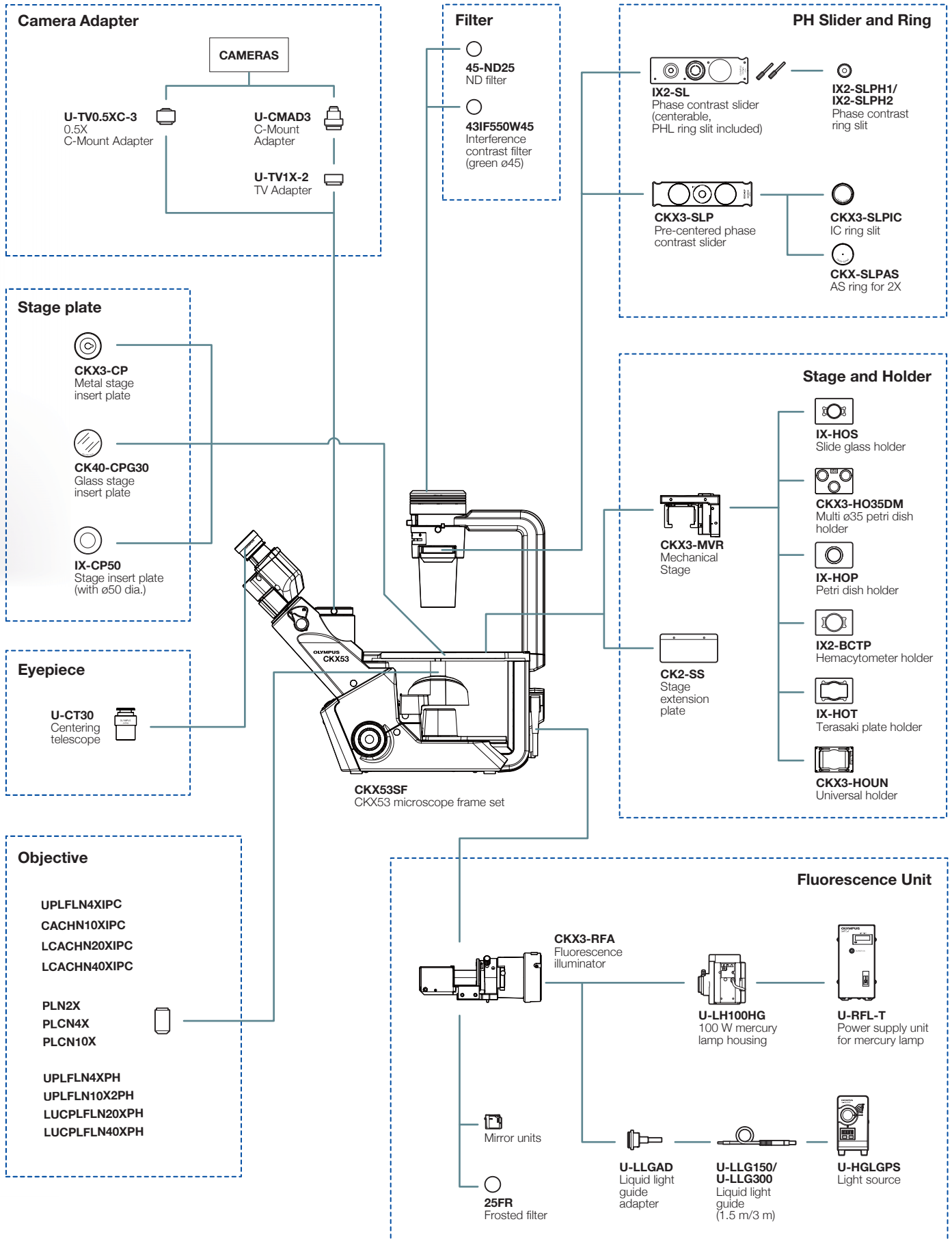



## SPECIFICATIONS

Item		CKX53		
Set model	Brightfield	Phase Contrast Entry	Phase Contrast Standard	Fluorescence
Optical system	UIS2 (Universal Infinity-corrected) optical system			
Focus	Revolving nosepiece vertical movement system using the coarse and fine focusing knobs. Stroke: 20mm (Focal point: up to 18.5 mm from the plain stage top surface) Stroke per rotation : 36.8mm (Coarse), 0.2mm (Fine)			
Stage	Plain stage	200 mm (L) X 252 mm (W) Exchangeable transparent insert plate is incorporated		
	Mechanical stage	Options	XY coaxial knob placed on right side of the plain stage Microplate holder equipped with the escape function stage stroke: X = 110 mm, Y = 74 mm	
	Substage	70 mm (L) X 180 mm (W)		
Illumination system	Light source	4000K color temperature LED light source		
	Filter holder	Insert up to 6mm thick with ø45mm filter, detachable		
	Aperture diaphragm	Diaphragm blade, manual open/close system		
	Slider insertion	Options	With phase slider pocket and built-in slider position click stop mechanism pre-centered iPC aperture in 4X, 10X, 20X and 40X insertion direction can be adjusted by the range of ±30 degrees to right or left sides	
iPC slider	Options	Pre-centered phase contrast aperture for 4X, 10X, 20X and 40X and 2 ø45mm empty apertures		
Condenser	Maximum numerical aperture: 0.3 Working distance: 72mm Applicable objective magnification 2X, 4X, 10X, 20X and 40X up to 190mm height tissue flask can be loaded on the stage without detachable condenser			
Observation tube	Fixed Trinocular tube, inclined 45 degrees Interpupillary distance 48-75mm Light path: eyepiece/camera port = 100/0 ⇔ 0/100			
Camera port	Olympus camera adapter interface			
Eye-piece	Magnification: 10X FN 22			
Fluorescence illuminator	FL light source	Options	Detachable illuminator 3CH Switchable slide	
	FL light shutter		100W Hg	
	FL field stop		Available	
	FL mirror units		Available	
	Umbra shield		2 mirror units (B & G) and UIS2 mirror unit (option)  Umbra shield is available to prevent from room light	
Rated Voltage/ Electric Current	AC 100-240V 50/60 Hz 0.4A			
Power Consumption	Less than 4W			

## UIS2 OBJECTIVES

Objective	NA	W.D.	Remarks
PLN2X	0.06	5.8	
PLCN4X	0.1	18.5	
PLCN10X	0.25	10.6	
UPLFLN4XIPC	0.13	16.4	For use with CKX3-SLP
CACHN10XIPC	0.25	8.8	For use with CKX3-SLP
LCACHN20XIPC	0.4	3.2	For use with CKX3-SLP
LCACHN40XIPC	0.55	2.2	For use with CKX3-SLP
UPLFLN4XPH	0.13	16.4	PHL (For use with IX2-SL)
UPLFLN10X2PH	0.3	10	PH1 (For use with IX2-SL)
LUCPLFLN20XPH	0.45	6.6-7.8	PH1 (For use with IX2-SL)
LUCPLFLN40XPH	0.6	3-4.2	PH2 (For use with IX2-SL)

## DIMENSIONS

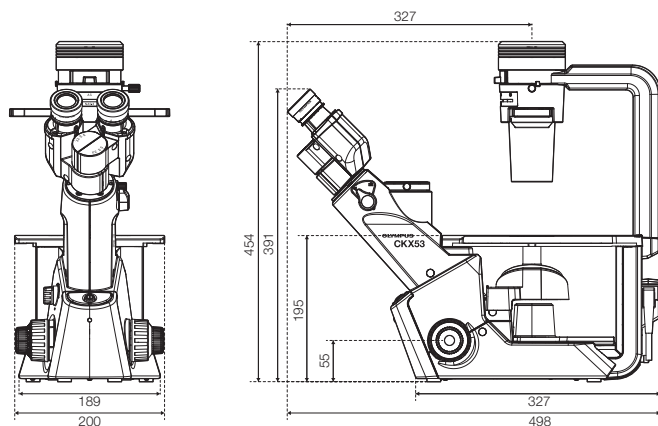

(Unit: mm)

[www.olympus-lifescience.com](http://www.olympus-lifescience.com)

- OLYMPUS CORPORATION is ISO14001 certified.
- OLYMPUS CORPORATION is ISO9001 certified.
- OLYMPUS CORPORATION is ISO13485 certified.
- Illumination devices for microscope have suggested lifetimes. Periodic inspections are required. Please visit our website for details.

- All company and product names are registered trademarks and/or trademarks of their respective owners.
- Images on the PC monitors are simulated.
- Specifications and appearances are subject to change without any notice or obligation on the part of the manufacturer.

**OLYMPUS**<sup>®</sup>

For enquiries - contact

[www.olympus-lifescience.com/contact-us](http://www.olympus-lifescience.com/contact-us)

### OLYMPUS CORPORATION

Shinjuku Monolith, 2-3-1 Nishi-Shinjuku, Shinjuku-ku, Tokyo 163-0914, Japan

### OLYMPUS EUROPA SE & CO. KG

Wendenstrasse 14-18, 20097 Hamburg, Germany

### OLYMPUS SCIENTIFIC SOLUTIONS AMERICAS CORP.

48 Woerd Avenue, Waltham, MA 02453, U.S.A.

### OLYMPUS SINGAPORE PTE LTD.

491B River Valley Road, #12-01/04 Valley Point Office Tower, Singapore 248373

### OLYMPUS MEDICAL SYSTEMS INDIA PRIVATE LIMITED.

102-B, First Floor, Time Tower, M.G. Road, Gurgaon 122001, Haryana, INDIA

### OLYMPUS LATIN AMERICA, INC.

5301 Blue Lagoon Drive, Suite 290 Miami, FL 33126, U.S.A.

### OLYMPUS (CHINA) CO., LTD.

A8F, Ping An International Financial Center, No. 1-3, Xinyuan South Road, Chaoyang District, Beijing, 100027 P.R.C.

### OLYMPUS KOREA CO., LTD.

8F Olympus Tower, 446 Bongseunsa-ro, Gangnam-gu, Seoul, 135-509 Korea

### OLYMPUS AUSTRALIA PTY. LTD.

3 Acacia Place, Notting Hill VIC 3168, Australia