

# Oxi 3310



## Dissolved oxygen (D.O.) meter

**Accuracy when  
going to press**

The use of advanced technology and the high quality standard of our instruments are the result of a continuous development. This may result in differences between this operating manual and your meter. Also, we cannot guarantee that there are absolutely no errors in this manual. Therefore, we are sure you will understand that we cannot accept any legal claims resulting from the data, figures or descriptions.

**Copyright**

© Weilheim 2009, WTW GmbH  
Reproduction in whole - or even in part - is prohibited without the express written permission of WTW GmbH, Weilheim.  
Printed in Germany.

## Oxi 3310 - Contents

<b>1</b>	<b>Overview</b>	<b>5</b>
1.1	Keypad	6
1.2	Display	7
1.3	Socket field	8
<b>2</b>	<b>Safety</b>	<b>9</b>
2.1	Authorized use	10
2.2	General safety instructions	10
<b>3</b>	<b>Commissioning</b>	<b>13</b>
3.1	Scope of delivery	13
3.2	Initial commissioning	13
3.2.1	Inserting the batteries	13
3.2.2	Switching on the meter	14
3.2.3	Setting the date and time	14
<b>4</b>	<b>Operation</b>	<b>15</b>
4.1	Switching on the meter	15
4.2	General operating principles	16
4.2.1	Operating modes	16
4.2.2	Navigation	17
4.2.3	Example 1 on navigation: Setting the language	19
4.2.4	Example 2 on navigation: Setting the date and time	21
4.3	Sensor-independent settings	23
4.3.1	<i>System</i>	23
4.3.2	<i>Data storage</i>	24
4.3.3	<i>Automatic Stability control</i>	24
4.4	Dissolved oxygen	25
4.4.1	General information	25
4.4.2	Measuring	26
4.4.3	Settings for D.O. sensors (menu or measurement and calibration settings)	28
4.4.4	D.O. calibration	30
4.4.5	Displaying calibration records	33
4.5	Data storage	35
4.5.1	Manual storage	36
4.5.2	Automatic storage at intervals	37
4.5.3	Displaying and editing the measurement data storage	39
4.5.4	Erasing the measurement data storage	41
4.6	Transmitting data (USB interface)	42

- 4.6.1 Options for data transmission . . . . . 42
- 4.6.2 Connecting a PC . . . . . 43
- 4.6.3 Operation with MultiLab pilot . . . . . 43
- 4.7 Reset . . . . . 44
  - 4.7.1 Resetting the measurement settings . . . . . 44
  - 4.7.2 Resetting the system settings . . . . . 45
- 5 Maintenance, cleaning, disposal . . . . . 47**
  - 5.1 Maintenance . . . . . 47
    - 5.1.1 Replacing the batteries . . . . . 47
  - 5.2 Cleaning . . . . . 48
  - 5.3 Packing . . . . . 48
  - 5.4 Disposal . . . . . 48
- 6 What to do if... . . . . . 49**
- 7 Technical data . . . . . 51**
  - 7.1 General data . . . . . 51
  - 7.2 Measuring ranges, resolution, accuracy . . . . . 52
- 8 Lists . . . . . 55**
- Appendix: Firmware update . . . . . 59**

# 1 Overview

The Oxi 3310 compact precision dissolved oxygen (D.O.) meter enables you to perform D.O. measurements quickly and reliably.

The Oxi 3310 provides the maximum degree of operating comfort, reliability and measuring certainty for all applications. The proven OxiCal calibration procedure supports you in your work with the D.O. meter.

The USB interface can be used for data transmission to a PC and for software updates of the meter.

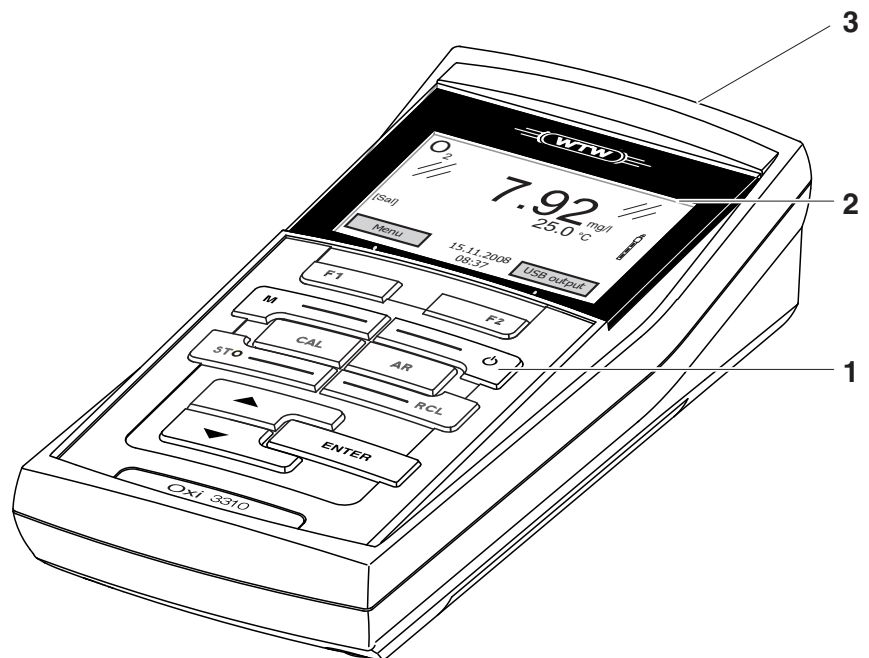

1	Keypad
2	Display
3	Socket field

### 1.1 Keypad

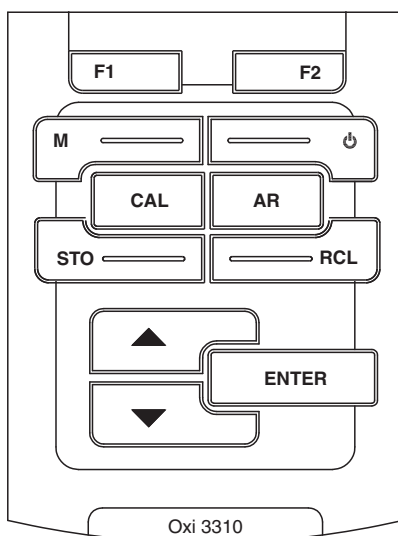

In this operating manual, keys are indicated by brackets <...> .  
 The key symbol (e.g. <ENTER>) generally indicates a short keystroke (under 2 sec) in this operating manual. A long keystroke (approx. 2 sec) is indicated by the underscore behind the key symbol (e.g. <ENTER\_\_>).

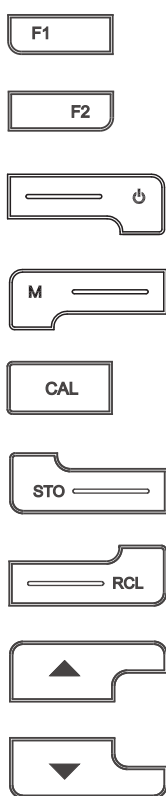

<F1>: <F1__>: <F2>: <F2__>:	Softkeys providing situation dependent functions, e.g.: <F1>/[Menü]: Opens the menu for measurement settings <F1__>/[Menü]: Opens the menu for system settings
<On/Off>:	Switches the meter on or off
<M>:	Selects the measured parameter
<CAL>: <CAL__>:	Calls up the calibration procedure Displays the calibration data
<STO>: <STO__>:	Saves a measured value manually Opens the menu for the automatic save function
<RCL>: <RCL__>:	Displays the manually stored measured values Displays the automatically stored measured values
<▲>:	Increments values, scrolls
<▼>:	Decrements values, scrolls

ENTER	<b>&lt;ENTER&gt;</b> :	Opens the menu for measurement settings / confirms entries
	<b>&lt;ENTER_&gt;</b> :	Opens the menu for system settings
AR	<b>&lt;AR&gt;</b>	Freezes the measured value (HOLD function) Switches the AutoRead measurement on or off

## 1.2 Display

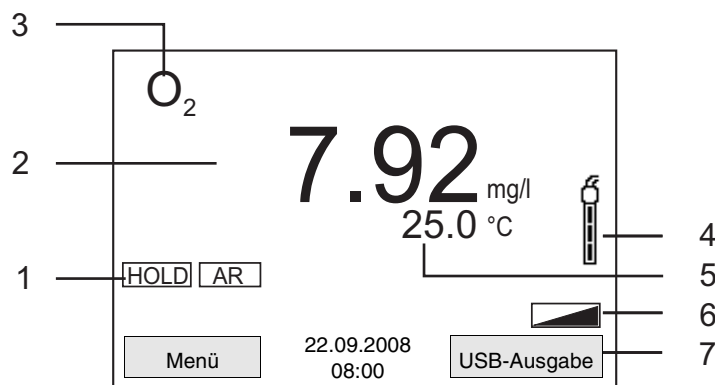

1	Status information
2	Measured value (with unit)
3	Measured parameter
4	Sensor symbol (calibration evaluation, calibration interval)
5	Measured temperature (with unit)
6	Status line
7	Softkeys and date + time

### Function display indicators

Error	An error occurred during calibration
AR	Stability control (AutoRead) is active
HOLD	Measured value is frozen (<AR> key)

### 1.3 Socket field

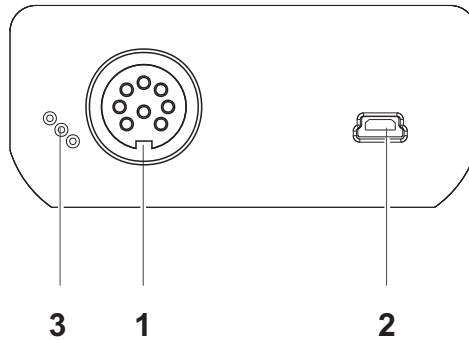

Connectors:

1	D.O. sensor
2	USB B (device) interface
3	Service interface



#### Caution

Only connect D.O. sensors to the meter that cannot return any voltages or currents that are not allowed (> SELV and > current circuit with current limiting).  
Almost all customary D.O. sensors fulfill these conditions.



## 2 Safety

This operating manual contains basic instructions that you must follow during the commissioning, operation and maintenance of the meter. Consequently, all responsible personnel must read this operating manual before working with the meter.

The operating manual must always be available within the vicinity of the meter.

### Target group

The meter was developed for work in the field and in the laboratory. Thus, we assume that, as a result of their professional training and experience, the operators will know the necessary safety precautions to take when handling chemicals.

### Safety instructions

Safety instructions in this operating manual are indicated by the warning symbol (triangle) in the left column. The signal word (e.g. "Caution") indicates the level of danger:



#### Warning

**indicates instructions that must be followed precisely in order to avoid possibly great dangers to personnel.**



#### Caution

**indicates instructions that must be followed precisely in order to avoid the possibility of slight injuries or damage to the meter or the environment.**

### Further notes



#### Note

indicates notes that draw your attention to special features.



#### Note

indicates cross-references to other documents, e.g. operating manuals.

## 2.1 Authorized use

The authorized use of the meter consists exclusively of the measurement of dissolved oxygen and temperature of liquid media in a field and laboratory environment.

The technical specifications as given in chapter 7 TECHNICAL DATA must be observed. Only the operation and running of the meter according to the instructions given in this operating manual is authorized.

Any other use is considered **unauthorized**.

## 2.2 General safety instructions

This meter is constructed and tested in compliance with the IEC 1010 safety regulations for electronic measuring instruments.

It left the factory in a safe and secure technical condition.

### Function and operational safety

The smooth functioning and operational safety of the meter can only be guaranteed if the generally applicable safety measures and the specific safety instructions in this operating manual are followed during operation.

The smooth functioning and operational safety of the meter can only be guaranteed under the environmental conditions that are specified in chapter 7 TECHNICAL DATA.

If the meter was transported from a cold environment to a warm environment, the formation of condensate can lead to the faulty functioning of the meter. In this event, wait until the temperature of the meter reaches room temperature before putting the meter back into operation.

### Caution

**The meter is only allowed to be opened by authorized personnel.**



**Safe operation**

If safe operation is no longer possible, the meter must be taken out of service and secured against inadvertent operation!

Safe operation is no longer possible if the meter:

- has been damaged in transport
- has been stored under adverse conditions for a lengthy period of time
- is visibly damaged
- no longer operates as described in this manual.

If you are in any doubt, please contact the supplier of the meter.

**Obligations of the purchaser**

The purchaser of this meter must ensure that the following laws and guidelines are observed when using dangerous substances:

- EEC directives for protective labor legislation
- National protective labor legislation
- Safety regulations
- Safety datasheets of the chemical manufacturers.

**Caution**

**In addition to the safety instructions mentioned here, also follow the safety instructions of the sensors used.**

**The operating manuals of the sensors are available on the supplied CD and on the Internet under [www.WTW.com](http://www.WTW.com).**



## 3 Commissioning

### 3.1 Scope of delivery

- D.O. meter Oxi 3310
- 4 batteries 1.5 V Mignon type AA
- USB cable
- Short instructions
- CD-ROM with detailed operating manual

### 3.2 Initial commissioning

Perform the following activities:

- Insert the supplied batteries
- Switch on the meter
- Set the date and time

#### 3.2.1 Inserting the batteries

1	Unscrew the two screws (1) on the underside of the meter.
2	Open the battery compartment (2) on the underside of the meter.

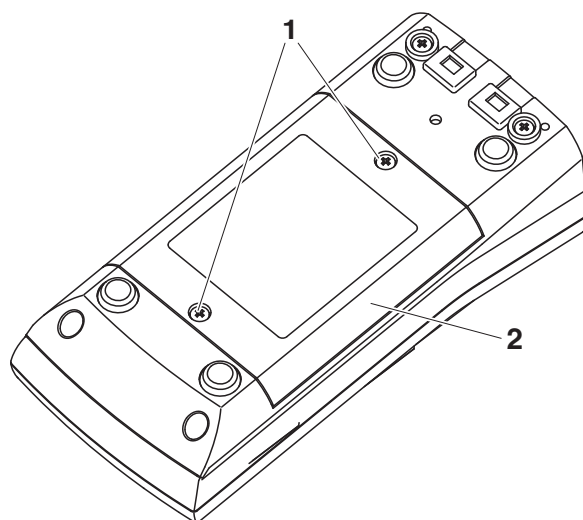

- 3 Place four batteries (type Mignon AA) in the battery compartment.

**Note**

Alternatively, you can also use Ni-MH rechargeable batteries (type Mignon AA). In order to charge the batteries, an external charging device is required.

**Caution**

**Make sure that the poles of the batteries are positioned correctly. The  $\pm$  signs on the batteries must correspond to the  $\pm$  signs in the battery compartment.**

- 4 Close the battery compartment (2) and tighten the screws (1).

### 3.2.2 Switching on the meter

- 1 Press the **<On/Off>** key.  
The meter performs a self-test.  
The display shows the manufacturer's logo while the self-test is being performed.  
Subsequently, the meter switches to the measuring mode (measured value display).

**Note**

The meter has an energy saving feature to avoid unnecessary battery depletion.

The energy saving feature switches off the measuring instrument if no key is pressed during the adjusted interval. (How to set the switch-off interval, see section 4.3.1).

### 3.2.3 Setting the date and time

- 1 See section 4.2.4

## 4 Operation

### 4.1 Switching on the meter

#### Switching on

Press the <On/Off> key.

The meter performs a self-test.

The display shows the manufacturer's logo while the self-test is being performed.

The measured value display appears.

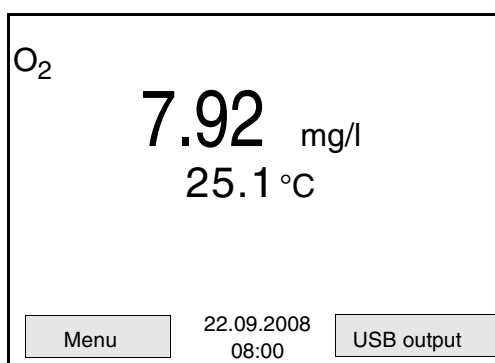

#### Switching off

Press the <On/Off> key.

#### Automatic switch-off function

The instrument has an automatic switch-off function in order to save the batteries (see section 4.3.1). The automatic switch-off function switches off the measuring instrument if no key is pressed for an adjustable period.

The automatic switch-off function is not active

- if the meter is supplied with power via a connected USB cable
- if the *Automatic data storage* function is active, or with automatic data transmission

#### Display illumination

The meter automatically switches off the display illumination if no key is pressed for 30 seconds. The illumination is switched on with the next keystroke again.

You can also generally switch the display illumination on or off (see section 4.3.1).

## 4.2 General operating principles

This section contains basic information on the operation of the Oxi 3310.

### Operating elements, display

An overview of the operating elements and the display is given in section 1.1 and section 1.2.

### Operating modes, navigation

An overview of the operating modes and navigation of the Oxi 3310 is given in section 4.2.1 and section 4.2.2.

### 4.2.1 Operating modes

The meter has the following operating modes:

- Measuring  
The measurement data of the connected sensor is shown in the measured value display
- Calibration  
The course of a calibration with calibration information, functions and settings is displayed
- Data storage  
The meter stores measurement data manually or automatically
- Transmitting data  
The measuring instrument transmits measurement data and calibration records to the USB interface automatically or manually.
- Setting  
The system menu or a sensor menu with submenus, settings and functions is displayed



## 4.2.2 Navigation

### Measured value display

In the measured value display, you can

- Open the menu for calibration and measurement settings with **<F1>** (short keystroke)
- Open the *Storage & config* menu with the sensor-independent settings with **<F1 \_\_>** (long keystroke (approx. 2 s).
- Change the display in the measurement window by pressing **<M>** (e.g. D.O. concentration → D.O. saturation index → D.O. partial pressure →).

### Menus and dialogs

The menus for settings and dialogs in procedures contain further submenus. The selection is made with the **<▲><▼>** keys. The current selection is displayed with a frame.

- Submenus

The name of the submenu is displayed at the upper edge of the frame. Submenus are opened by confirming with **<ENTER>**.

Example:

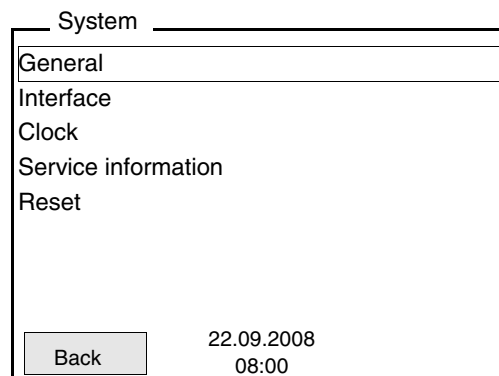

- Settings

Settings are indicated by a colon. The current setting is displayed on the right-hand side. The setting mode is opened with **<ENTER>**.

Subsequently, the setting can be changed with **<▲><▼>** and **<ENTER>**. Example:

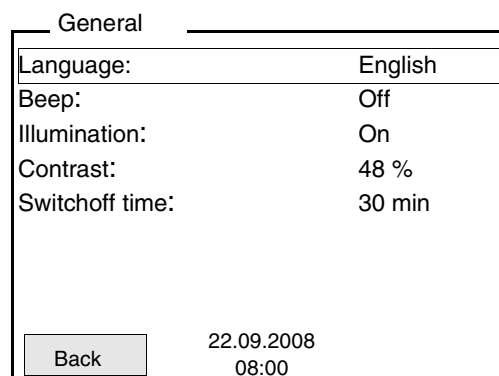

- **Functions**

Functions are designated by the name of the function. They are immediately carried out by confirming with **<ENTER>**.

Example: Display the *Calibration record* function.

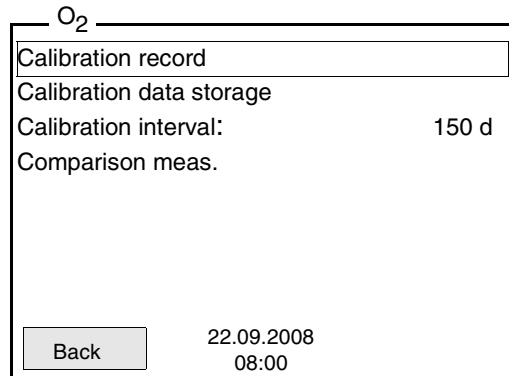

**Messages**

Information is marked by the **i** symbol. It cannot be selected. Example:

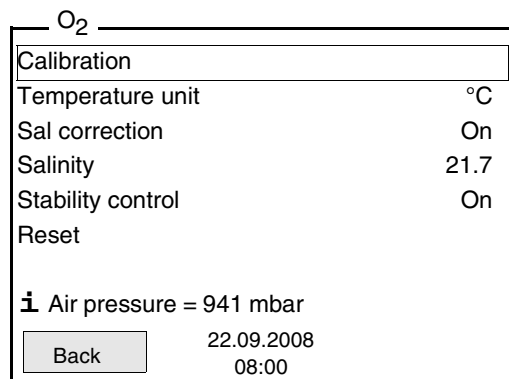

**Note**

The principles of navigation are explained in the two following sections by reference of examples:

- Setting the language (section 4.2.3)
- Setting the date and time (see section 4.2.4).

### 4.2.3 Example 1 on navigation: Setting the language

- 1 Press the **<On/Off>** key.  
The measured value display appears.  
The instrument is in the measuring mode.

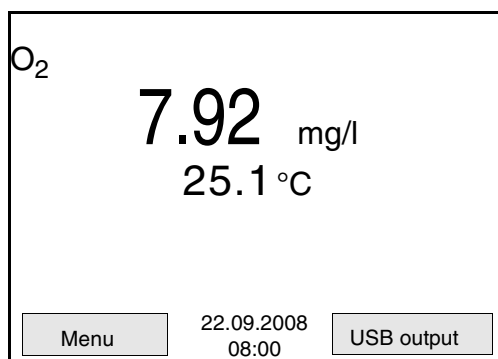

- 2 Using **<F1\_\_>/[Menu]** open the *Storage & config* menu.  
The instrument is in the setting mode.

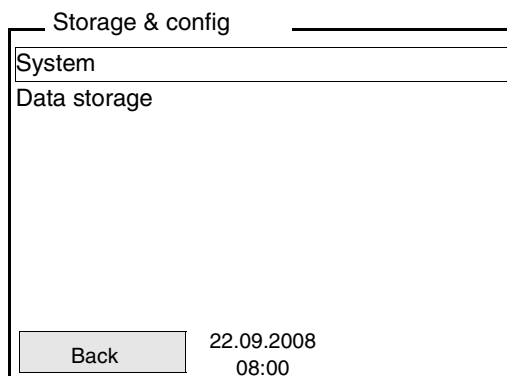

- 3 Select the *System* submenu with **<▲><▼>**.  
The current selection is displayed with a frame.
- 4 Open the *System* submenu with **<ENTER>**.

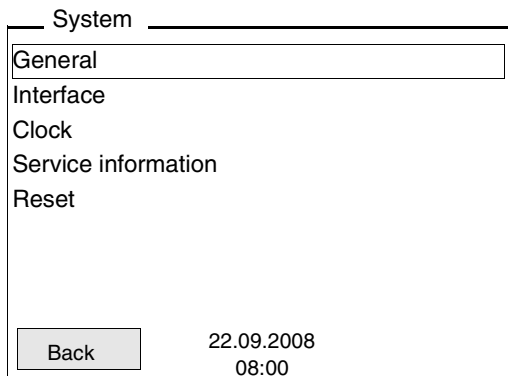

5 | Select the *General* submenu with <▲><▼>. The current selection is displayed with a frame.

6 | Open the *General* submenu with <ENTER>.

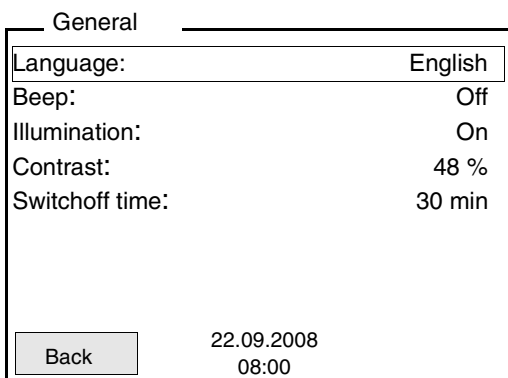

7 | Open the setting mode for the *Language* with <ENTER>.

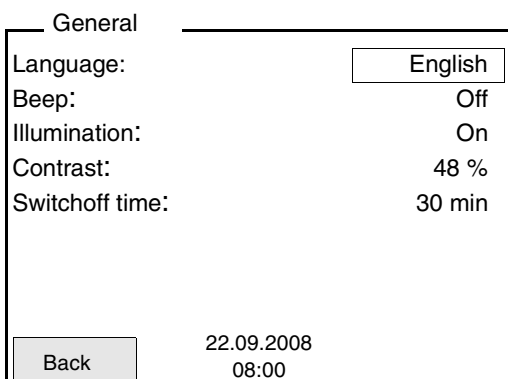

8 | Select the required language with <▲><▼>.

- 9 | Confirm the setting with **<ENTER>**.  
The meter switches to the measuring mode.  
The selected language is active.

#### 4.2.4 Example 2 on navigation: Setting the date and time

The measuring instrument has a clock with a date function. The date and time are indicated in the status line of the measured value display. When storing measured values and calibrating, the current date and time are automatically stored as well.

The correct setting of the date and time and date format is important for the following functions and displays:

- Current date and time
- Calibration date
- Identification of stored measured values.

Therefore, check the time at regular intervals.



#### Note

After a fall of the supply voltage (empty batteries), the date and time are reset to 01.01.2008, 00:00 hours.

#### Setting the date, time and date format

The date format can be switched from the display of day, month, year (*dd.mm.yyyy*) to the display of month, day, year (*mm/dd/yyyy* or *mm.dd.yyyy*).

1	In the measured value display: Using <b>&lt;F1__&gt;</b> / <i>[Menu]</i> , open the <i>Storage &amp; config</i> menu. The instrument is in the setting mode.
2	Select and confirm the <i>System / Clock</i> menu with <b>&lt;▲&gt;&lt;▼&gt;</b> and <b>&lt;ENTER&gt;</b> . The setting menu for the date and time opens up.
3	Select and confirm the <i>Time</i> menu with <b>&lt;▲&gt;&lt;▼&gt;</b> and <b>&lt;ENTER&gt;</b> . The hours are highlighted.

Clock	
Date format:	dd.mm.yyyy
Date:	30.10.2008
Time:	14:53:40
<input type="button" value="Back"/> <span style="margin-left: 100px;">22.09.2008</span> <span style="margin-left: 100px;">08:00</span>	

- |   |  |
|---|--|
| 4 | Change and confirm the setting with <▲><▼> and <ENTER>. The minutes are highlighted.   |
| 5 | Change and confirm the setting with <▲><▼> and <ENTER>. The seconds are highlighted.   |
| 6 | Change and confirm the setting with <▲><▼> and <ENTER>. The time is set.   |
| 7 | If necessary, set the <i>Date</i> and <i>Date format</i> . The setting is made similarly to that of the time.  |
| 8 | To make further settings, switch to the next higher menu level with [Back]<F1>. or Switch to the measured value display with <M>. The instrument is in the measuring mode. |

### 4.3 Sensor-independent settings

The *Storage & config* menu comprises the following settings:

- *System* (see section 4.3.1).
- *Data storage* (see section 4.3.2)

#### 4.3.1 System

##### Overview

The following sensor-independent meter characteristics can be adjusted in the *Storage & config/System* menu:

- Menu language
- Beep on keystroke
- Illumination
- Display contrast
- Interval of the automatic switch-off function
- Data interface
- Clock and date function
- Reset of all sensor-independent system settings to the default condition

##### Settings

To open the *Storage & config* menu, press the <F1\_\_>[Menu] key in the measured value display. After completing the settings, switch to the measured value display with <M>.

Menu item	Setting	Description
<i>System / General / Language</i>	<i>Deutsch</i> <i>English</i> (further)	Select the menu language
<i>System / General / Beep</i>	<i>On</i> <i>Off</i>	Switch on/off the beep on keystroke
<i>System / General / Illumination</i>	<i>Auto</i> <i>On</i> <i>Off</i>	Switching the display illumination on/off
<i>System / General / Contrast</i>	0 ... 100 %	Changing the display contrast
<i>System / General / Switchoff time</i>	10 min ... 24 h	Adjust the switch-off time
<i>System / Interface / Baud rate</i>	1200, 2400, 4800, 9600, 19200	Baud rate of the data interface

Menu item	Setting	Description
<i>System / Interface / Output format</i>	<i>ASCII</i> <i>CSV</i>	Output format for data transmission For details, see section 4.6
<i>System / Interface / Decimal separator</i>	<i>Dot (xx.x)</i> <i>Comma (xx,x)</i>	Decimal separator
<i>System / Interface / Output header</i>		Output of a header for <i>Output format: CSV</i>
<i>System / Clock</i>	<i>Time</i> <i>Date</i> <i>Date format</i>	Settings of time and date. For details, see section 4.2.4
<i>System / Service information</i>		Hardware version and software version of the meter are displayed.
<i>System / Reset</i>	-	Resets the system settings to the default values. For details, see section 4.7.2

### 4.3.2 Data storage

This menu contains all functions to display, edit and erase stored measured values and calibration records.



#### Note

Detailed information on the storage functions of the Oxi 3310 is given in section 4.5.

### 4.3.3 Automatic Stability control

The function, automatic *Stability control* (AutoRead) continually checks the stability of the measurement signal. The stability has a considerable impact on the reproducibility of measured values.

You can activate or switch off the automatic *Stability control* function (see section 4.4.3).

The measured parameter flashes on the display

- as soon as the measured value is outside the stability range
- if you switch over between the measured parameters with **<M>**.
- if the automatic *Stability control* is switched off.



## 4.4 Dissolved oxygen

### 4.4.1 General information

You can measure the following parameters:

- D.O. concentration
- D.O. saturation index ("D.O. saturation")
- D.O. partial pressure

D.O. measurements with the Oxi 3310 can be carried out with the CelloX 325 or DurOx 325 D.O. sensor. The measuring instrument automatically recognizes the type of the connected D.O. sensor.



**Temperature  
measurement**

#### Preparatory activities

#### Warning

**When connecting an earthed PC, measurements cannot be performed in earthed media as incorrect values would result. The USB interface is not galvanically isolated.**

The CelloX 325 and DurOx 325 D.O. sensors have an integrated temperature sensor.

Perform the following preparatory activities when you want to measure:

1	Connect the D.O. sensor to the meter. The D.O. measuring window is displayed.
2	Calibrate or check the meter with the sensor.



#### Note

Incorrect calibration of D.O. sensors will result in incorrect measured values. Calibrate at regular intervals.

#### 4.4.2 Measuring

You can carry out D.O. measurements as follows:

1	Perform the preparatory activities according to section 4.4.1.
2	Immerse the D.O. sensor in the test sample.

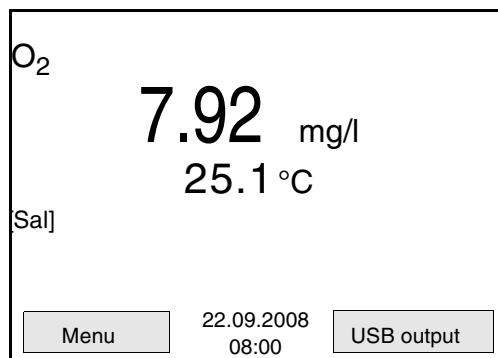

#### Selecting the displayed measured parameter

You can switch between the following displays with **<M>**:

- D.O. concentration [mg/l]
- D.O. saturation [%]
- D.O. partial pressure [mbar].

#### Salinity correction

When measuring the concentration of solutions with a salt content of more than 1 g/l, a salinity correction is required. For this, you have to measure and input the salinity of the measured medium first. When the salinity correction is switched on, the *[Sal]* indicator is displayed in the measuring window.



#### Note

You can switch the salinity correction on or off and enter the salinity in the menu for calibration and measurement settings (see section 4.4.3).

#### Freezing the measured value (HOLD function)

With the HOLD function, you can freeze the current measured value. The displayed measured value stops changing until you switch the HOLD function off.

1	Freeze the measured value with <b>&lt;AR&gt;</b> . The [HOLD] status indicator is displayed.
---	---



#### Note

If the HOLD function is active, you can, e.g. start a manual measurement with stability control.

- |   |   |
|---|---|
| 2 | Release the frozen measured value again with <b>&lt;AR&gt;</b> .<br>The HOLD function is switched off.<br>The [HOLD] status display disappears. |
|---|---|

### Stability control (AutoRead)

The stability control function (AutoRead) continually checks the stability of the measurement signal. The stability has a considerable impact on the reproducibility of measured values.

The measured parameter flashes on the display

- as soon as the measured value is outside the stability range
- when the automatic *Stability control* is switched off.

You can start the *Stability control* function manually at any time, irrespective of the setting for automatic *Stability control* (see page 24) in the *Measurement* menu.

- |   |  |
|---|--|
| 1 | Freeze the measured value with <b>&lt;AR&gt;</b> .<br>The [HOLD] status indicator is displayed.<br>The HOLD function is active.  |
| 2 | Using <b>&lt;ENTER&gt;</b> , activate the <i>Stability control</i> function manually.<br>The [AR] status indicator appears while the measured value is assessed as not stable. A progress bar is displayed and the display of the measured parameter flashes.<br>The [HOLD][AR] status indicator appears as soon as a stable measured value is recognized. The current measurement data is output to the interface.<br>Measurement data meeting the stability control criterion is marked by AR. |



#### Note

You can prematurely terminate the *Stability control* function manually with **<ENTER>** at any time. If the *Stability control* function is prematurely terminated, the current measurement data are output to the interface without the AutoRead info.

- |   |  |
|---|--|
| 3 | Using <b>&lt;ENTER&gt;</b> , start a further measurement with <i>Stability control</i> .<br>or<br>Release the frozen measured value again with <b>&lt;AR&gt;</b> .<br>The display switches to the measured value display.<br>The [AR][HOLD] status display disappears. |
|---|--|

### Criteria for a stable measured value

The *Stability control* function checks whether the measured values are stable within the monitored time interval.

Measured parameter	Time interval	Stability in the time interval
D.O. concentration	20 seconds	$\Delta$ : better than 0.05 mg/l
D.O. saturation	20 seconds	$\Delta$ : better than 0.6 %
D.O. partial pressure	20 seconds	$\Delta$ : Better than 1.2 mbar
Temperature	15 seconds	$\Delta T$ (° C): Better than 0.02

The minimum duration until a measured value is assessed as stable is the monitored time interval. The actual duration is mostly longer.

#### 4.4.3 Settings for D.O. sensors (menu or measurement and calibration settings)

##### Overview

The following settings are possible for D.O. sensors:

- Salinity correction
- Salinity (salinity equivalent)
- Calibration interval
- Comparison meas.
- Automatic *Stability control*

##### Settings

The settings are available in the menu for measurement and calibration settings. To open the settings, display the required parameter in the measured value display and press the <F1>/[menu] or <ENTER> key. After completing the settings, switch to the measured value display with <M>.

Menu item	Possible setting	Description
<i>Calibration / Calibration record</i>	-	Displays the calibration record of the last calibration.
<i>Calibration / Calibration interval</i>	1 ... 999 d	<i>Calibration interval</i> for the D.O. sensor (in days). The meter reminds you to calibrate regularly by the flashing sensor symbol in the measuring window.

<b>Menu item</b>	<b>Possible setting</b>	<b>Description</b>
<i>Calibration / Comparison meas.</i>	<i>On</i> <i>Off</i>	Enables to adjust the measured value with the aid of a comparison measurement, e.g. Winkler titration. For details, see section 4.4.4.
<i>Sal correction</i>	<i>On</i> <i>Off</i>	Manual salt content correction for concentration measurements.
<i>Salinity</i>	0.0 ... 70.0	Salinity or salinity equivalent for the salt content correction. This function is only available for concentration measurements if the manual salt content correction is switched on.
<i>Stability control</i>	<i>On</i> <i>Off</i>	Switches on or off the automatic stability control during measurement (see section 4.3.3)
<i>Temperature unit</i>	°C °F	Temperature unit, degrees Celsius or degrees Fahrenheit. All temperatures are displayed with the selected unit.
<i>Reset</i>	-	Resets all sensor settings to the delivery condition (see section 4.7.1).

#### 4.4.4 D.O. calibration

##### Why calibrate?

D.O. sensors age. This changes the slope of the D.O. sensor. Calibration determines the current slope of the sensor and stores this value in the instrument.

##### When to calibrate?

- After connecting another D.O. sensor
- When the sensor symbol flashes (after the calibration interval has expired).

##### Calibration datasets

The Oxi 3310 administrates two sets of calibration data:

- Set 1 for the type, "CellOx": – CellOx 325
- Set 2 for the type, "DurOx": – DurOx 325

Sensors of different types can be calibrated separately from each other. When one sensor type is calibrated, the calibration data of the other type remains stored. The Oxi 3310 recognizes the type of the connected sensor and automatically uses the correct calibration data.

##### Calibration procedures

With the Oxi 3310, 2 calibration procedures are available:

- Calibration in water vapor-saturated air.  
Use an OxiCal<sup>®</sup> air calibration vessel for calibration.
- Calibration via a comparison measurement (e.g. Winkler titration according to DIN EN 25813 or ISO 5813). At the same time, the relative slope is adapted to the comparison measurement by a correction factor. When the correction factor is active, the *[Factor]* indicator appears in the measuring window.

##### Stability control (AutoRead)

In calibration, the Stability control function (AutoRead) is automatically activated.

##### Display calibration data and output to interface

You can have the data of the last calibration displayed (see section 4.4.5). Subsequently, you can transmit the displayed calibration data to the interface, e. g. to a PC, with the **<F2>***[USB output]* key.



##### Note

The calibration record is automatically transmitted to the interface after calibrating.

**Sample record:**

```



31.10.2008 16:55:12
Oxi 3310
Ser. no. 08502113

CALIBRATION O2
31.10.2008 16:13:33

S = 0.88 25.0 °C
Sensor +++
    
```

**Calibration evaluation**

After the calibration, the measuring instrument automatically evaluates the current status of the calibration. The evaluation appears on the display and in the calibration record.

Display	Calibration record	Relative slope
	+++	S = 0.8 ... 1.25
	++	S = 0.7 ... 0.8
	+	S = 0.6 ... 0.7
<i>Error</i>	<i>Error</i>	S < 0.6 or S > 1.25

Eliminate the error according to chapter 6 WHAT TO DO IF...

**Calibration in water vapor saturated air (air calibration vessel)**

For this calibration procedure, the *Comparison meas.* setting must be set to *Off* in the *Calibration* menu.

Proceed as follows to calibrate the instrument:

- 1 | Connect the D.O. sensor to the meter.
- 2 | Put the D.O. sensor into the air calibration vessel.



**Note**

The sponge in the air calibration vessel must be moist (not wet). Leave the sensor in the air calibration vessel for a time long enough to adjust.

- |   |   |
|---|---|
| 3 | Start the calibration with <b>&lt;CAL&gt;</b> .<br>The last calibration data (relative slope) is displayed. |
|---|---|

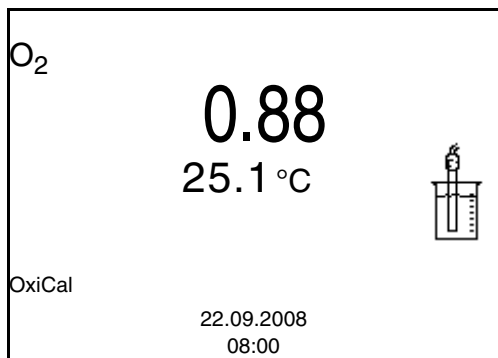

- |   |  |
|---|--|
| 4 | Start the measurement with <b>&lt;ENTER&gt;</b> .<br>The measured value is checked for stability (stability control).<br>The [AR] status indicator is displayed. The measured parameter flashes. |
| 5 | Wait for the end of the AutoRead measurement or accept the calibration value with <b>&lt;ENTER&gt;</b> .<br>The calibration record is displayed and output to the interface.                     |
| 6 | Using <b>&lt;F1&gt;</b> / <i>[Continue]</i> or <b>&lt;ENTER&gt;</b> , switch to the measured value display.  |

### Calibration by means of a *Comparison meas.*

For this calibration procedure, the *Comparison meas.* setting must be set to *On* in the *Calibration* menu.



#### Note

Before calibrating via a comparison measurement, the sensor should be calibrated in the air calibration vessel.

Proceed as follows to calibrate the instrument:

- |   |  |
|---|--|
| 1 | Connect the D.O. sensor to the measuring instrument. |
| 2 | Immerse the D.O. sensor in the reference solution.   |
| 3 | Start the calibration with <b>&lt;CAL&gt;</b> .      |



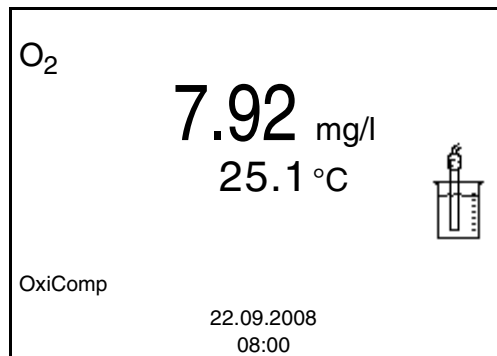

- |   |  |
|---|--|
| 4 | Start the measurement with <b>&lt;ENTER&gt;</b> .<br>The measured value is checked for stability (stability control).<br>The [AR] status indicator is displayed. The measured parameter flashes. |
| 5 | Wait for the end of the AutoRead measurement or accept the calibration value with <b>&lt;ENTER&gt;</b> .<br>The factor that was set last is displayed.   |

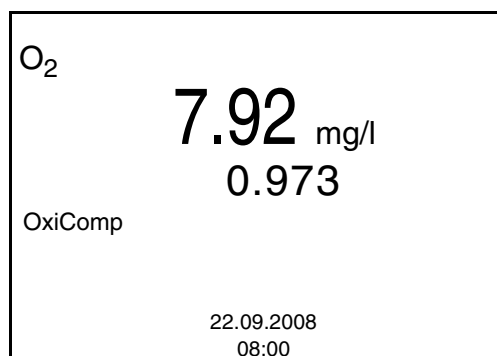

- |   |   |
|---|---|
| 6 | Using <b>&lt;▲&gt;</b> <b>&lt;▼&gt;</b> , set the correction factor to adjust the displayed concentration value to the nominal value (value of the comparison measurement). Subsequently, accept the correction factor with <b>&lt;ENTER&gt;</b> .<br>The measuring instrument switches to the measured value display.<br>The status display [ <i>Factor</i> ] is active. |
|---|---|

#### 4.4.5 Displaying calibration records

The calibration data can be displayed and then output to the interface.

The calibration record of the last calibration is to be found under the menu item, *Calibration / Calibration record*. To open it in the measured value display, press the **<CAL\_\_>** key.

#### Displaying the calibration record

The calibration records of the last calibrations (up to 10) are available in the menu, **<F1>/[Menu] / Calibration / Calibration data storage** and in the menu, **<F1\_\_>/[Menu] / Storage & config/Data storage / Calibration data storage**.

Menu item	Setting/ function	Description
<i>Calibration / Calibration data storage /Display</i>  or  <i>Data storage / Calibration data storage /Display</i>	-	Displays the calibration record.  Further options: <ul style="list-style-type: none"> <li>● Scroll through the calibration records with <b>&lt;▲&gt;&lt;▼&gt;</b>.</li> <li>● Output the displayed calibration record to the interface with <b>&lt;F2&gt;/[USB output]</b>.</li> <li>● Quit the display with <b>&lt;F1&gt;/[Back]</b> or <b>&lt;ENTER&gt;</b>.</li> <li>● Switch directly to the measured value display with <b>&lt;M&gt;</b>.</li> </ul>
<i>Calibration / Calibration data storage / Output to USB</i>  or  <i>Data storage / Calibration data storage /Output to USB</i>	-	Outputs the calibration records to the interface.

### Sample

```

31.10.2008 16:55:12
Oxi 3310
Ser. no. 08502113

CALIBRATION O2
31.10.2008 16:13:33

S = 0.88   25.0 °C
Sensor +++

etc...
```

## 4.5 Data storage

You can transmit measured values (datasets) to the data storage:

- Manual storage (see section 4.5.1)
- Automatic storage at intervals (see section 4.5.2)

Each storage process transmits the current dataset to the interface at the same time.

### Measurement dataset

A complete dataset consists of:

- ID number
- Date/time
- Measured value of the connected sensor
- Measured temperature value of the connected sensor
- AutoRead info: *AR* appears with the measured value if the AutoRead criterion was met while storing (stable measured value). Otherwise, the *AR* display is missing.
- Calibration evaluation: +++, ++, +, -, or no evaluation

### Storage locations

The Oxi 3310 meter has two measurement data memories. The measured values recorded either manually or automatic are stored separately in individual measurement data memories.

Storage	Maximum number of datasets
<i>Manual data storage</i>	200
<i>Automatic data storage</i>	5000

### 4.5.1 Manual storage

You can transmit a measurement dataset to the data storage as follows.

The dataset is at the same time output to the interface:

- 1 Press the **<STO>** key shortly.  
The menu for manual storage appears.

Manual data storage 4 From 200

30.10.2008 11:24:16  
pH 7.000 24.8 °C AR +++

ID number: 1

Continue

Back 22.11.2010  
08:00

- 2 If necessary, change and confirm the ID number (1 ... 10000) with **<▲>****<▼>** and **<ENTER>**.  
The dataset is stored. The meter switches to the measured value display.

#### If the storage is full

The following window appears if all 200 storage locations are occupied:

Warning

Data storage full. Erase?

Yes

No

Back 22.09.2008  
08:00

You have the following options:

- To erase the entire storage, confirm **Yes**.
- To cancel the storage process and switch to the measured value display, confirm **No**. Then you can e.g. transmit the stored data to a PC (see section 4.5.3) and subsequently erase the storage (see section 4.5.4).

### 4.5.2 Automatic storage at intervals

The storage interval (*Interval*) determines the time interval between automatic storage processes. Each storage process transmits the current dataset to the interface at the same time.

#### Configuring the automatic storage function

- 1 Press the <STO\_> key.  
The menu for automatic storage appears.

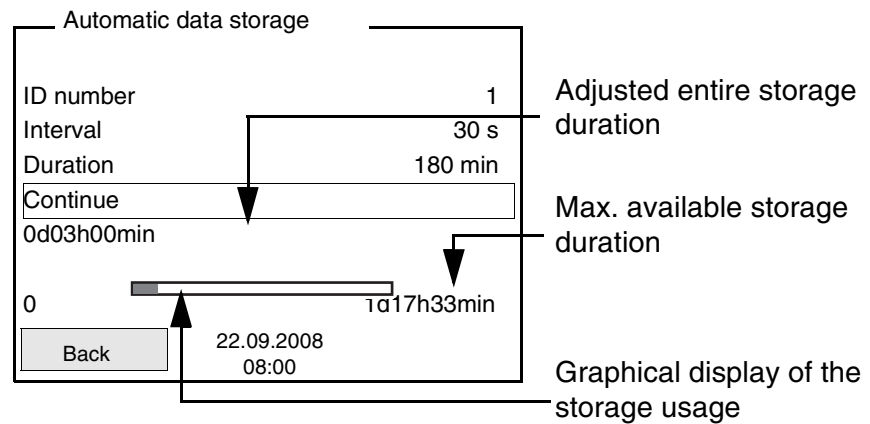

#### Settings

You can configure the automatic storage function with the following settings:

Menu item	Possible setting	Description
ID number	1 ... 10000	ID number for the dataset series.
<i>Interval</i>	1 s, 5 s, 10 s, 30 s, 1 min, 5 min, 10 min, 15 min, 30 min, 60 min	Storage interval.  The lower limit of the storage interval can be restricted by the number of free storage locations. The upper limit is restricted by the storage duration.

Menu item	Possible setting	Description
<i>Duration</i>	1 min ... x min	Storage duration. Specifies after which time the automatic storage should be terminated.  The lower limit of the storage duration is restricted by the storage interval. The upper limit is restricted by the number of free storage locations.

**Starting the automatic storage function**

To start the automatic storage function, select *Continue* with <▲><▼> and confirm with <ENTER>. The measuring instrument switches to the measured value display.

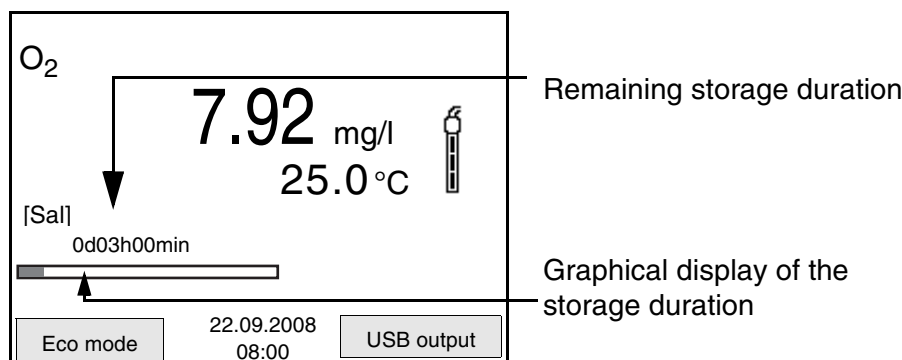

The active automatic storage function can be recognized by the progress bar in the status line. The progress bar indicates the remaining storage duration.



**Note**

If the automatic storage function is activated, only the following keys are active: Softkeys, <M>, <STO\_> and <On/Off>. The other keys and the automatic switch-off function are deactivated.

**Energy saving mode ([Eco mode])**

If the automatic storing function is active, the meter provides an energy saving mode ([Eco mode]) to avoid unnecessary energy consumption. The energy saving mode switches off functions of the meter that are not required for the automatic storage of measurement data (such as the display). By pressing any key the energy saving mode is switched off again.

### Terminating the automatic storage function prematurely

Proceed as follows to switch off the automatic storage function before the adjusted storage duration has expired:

- 1 Press the **<STO\_>** key.  
The following window appears.

Warning	
Stop automatic storage?	
<input type="radio"/> Yes <input type="radio"/> No	
Back	22.09.2008 08:00

- 2 Using **<▲><▼>**, select Yes and confirm with **<ENTER>**.  
The measuring instrument switches to the measured value display.  
The automatic storage function is terminated.

#### 4.5.3 Displaying and editing the measurement data storage

The contents of the manual or automatic measurement data storage can be shown on the display.

Each of the measurement data memories has a function to erase the entire contents.

The contents of the manual or automatic measurement data storage can be shown on the display and output to the interface.

#### Editing the data storage

The storage is edited in the menu, *Storage & config/ Data storage*. To open the *Storage & config* menu, press the **<F1 \_\_>**[Menu] key in the measured value display. Open the manual or automatic storage directly with the **<RCL>** or **<RCL\_>** key.



#### Note

The settings are explained here using the manual storage as an example. The same settings and functions are available for the automatic storage.

Settings	Menu item	Setting/ function	Description
	<i>Data storage / Manual data storage / Display</i>	-	Displays all measurement datasets page by page.  Further options: <ul style="list-style-type: none"> <li>● Scroll through the datasets with &lt;▲&gt;&lt;▼&gt;.</li> <li>● Output the displayed dataset to the interface with &lt;F2&gt;/[USB output].</li> <li>● Quit the display with &lt;F1&gt;/[Back].</li> </ul>
	<i>Data storage / Manual data storage / Erase</i>	-	Erases the entire manual measurement data storage.  <b>Note:</b> All calibration data remains stored when this action is performed.
	<i>Data storage / Manual data storage / Output to USB</i>	-	Outputs all stored measurement data to the interface.

**Display presentation of a dataset**

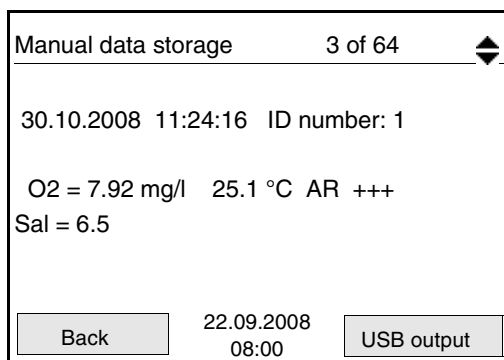



**Sample**

```
31.10.2008 09:27:20
Oxi 3310
Ser. No. 12345678

ID number 1
O2 = 7.92 mg/l      25.0 °C  AR  +++
Sal = 6.5

-----

31.10.2008 09:56:24
Oxi 3310
Ser. No. 12345678

ID number 1
O2 8.14 mg/l      25.0 °C  AR  +++
```

**Quitting the display**

To quit the display of stored measurement datasets, you have the following options:

- Switch directly to the measured value display with **<M>**.
- Quit the display and move to the next higher menu level with **<F1>/[Back]**.

**4.5.4 Erasing the measurement data storage**

How to erase the measurement data storage is described in section 4.5.3 DISPLAYING AND EDITING THE MEASUREMENT DATA STORAGE.

## 4.6 Transmitting data (USB interface)

### 4.6.1 Options for data transmission

Via the USB interface you can transmit data to a PC. The following table shows which data are transmitted to the interface in which way:

Data	Control	Operation / description
Current measured values of all connected D.O. sensors	Manual	<ul style="list-style-type: none"> <li>● With &lt;F2&gt;/[USB output].</li> <li>● Simultaneously with every manual storage process (see section 4.5.1).</li> </ul>
	Automatic, at intervals	<ul style="list-style-type: none"> <li>● With &lt;F2 __&gt;/[USB output]. Then you can set the transmission interval.</li> </ul> <p><b>Note:</b> For operation with MultiLab pilot: set the <i>Send ID</i> option to <i>No</i> (see section 4.6.3).</p> <ul style="list-style-type: none"> <li>● Simultaneously with every automatic storage process (see section 4.5.2).</li> </ul>
Stored measured values	Manual	<ul style="list-style-type: none"> <li>● Displayed dataset with &lt;F2 __&gt;/[USB output] after calling up from the storage.</li> <li>● All datasets with the <i>Output to USB</i> function.</li> </ul> <p>For details, see section 4.5.3.</p>
Calibration records	Manual	<ul style="list-style-type: none"> <li>● Calibration record with &lt;F2 __&gt;/[USB output].</li> </ul> <p>For details, see section 4.6.</p>
	Automatic	<ul style="list-style-type: none"> <li>● At the end of a calibration procedure.</li> </ul>



#### Note

The following rule applies: With the exception of the menus, shortly pressing the <F2>/[USB output] key generally outputs the display contents to the interface (displayed measured values, measurement datasets, calibration records).

#### 4.6.2 Connecting a PC

Connect the Oxi 3310 to the PC via the USB interface.



##### Warning

**The USB interface is not galvanically isolated.**

**When a grounded PC is connected, measurements cannot be performed in grounded media as incorrect values would result.**

#### Installation of the USB driver on the PC

System requirements of the PC for installation of the USB driver:

- PC with Pentium processor or higher with at least one free USB connection and CD-ROM drive
- Windows 2000, XP, Vista.

1	Insert the supplied installation CD in the CD drive of your PC.
2	Install the driver from the CD. Follow the Windows installation instructions as necessary.
3	Connect the Oxi 3310 to the PC via the USB interface. The meter is listed as a virtual COM interface among the connections in the Windows instrument manager.

#### 4.6.3 Operation with MultiLab pilot

With the aid of the MultiLab pilot software, you can record and evaluate measuring data with a PC. The data transmission takes place after the meter is connected to the USB interface of the PC.



##### Note

More detailed information can be found in the MultiLab pilot operating manual.



##### Note

To display the measurement data of the Oxi 3310 correctly on the PC, the Oxi 3310 has to be set up for communication with the MultiLab pilot. To do so, set the *Send ID* option to *No* in the menu for automatic storage (<F2\_\_>/[USB output]).

## 4.7 Reset

You can reset (initialize) all sensor settings and sensor-independent settings separately from each other.

### 4.7.1 Resetting the measurement settings



#### Note

The calibration data are reset to the default settings together with the measuring parameters. Recalibrate after performing a reset.

The following settings for D.O. measurements are reset to the default settings with the *Reset* function:

Setting	Default settings
Cal. interval	14 d
Comparison meas.	Off
Measured parameter	D.O. concentration
Relative slope ( $S_{Rel}$ )	1.00
Salinity (value)	0.0
Salinity (function)	Off
Stability control	On
Temperature unit	°C

The sensor settings are reset under the *Reset* menu item in the menu for calibration and measurement settings. To open the settings, display the required parameter in the measured value display and press the <F1>/[menu] or <ENTER> key.

#### 4.7.2 Resetting the system settings

The following system settings can be reset to the delivery status:

Setting	Default settings
Language	English
Beep	On
Baud rate	4800 Baud
Output format	ASCII
Contrast	50 %
Illumination	Auto
Switchoff time	1 h

The system settings are reset in the menu, *Storage & config / System / Reset*. To open the *Storage & config* menu, press the <F1 \_\_>[Menu] key in the measured value display.



## 5 Maintenance, cleaning, disposal

### 5.1 Maintenance

The only maintenance activity required is replacing the batteries.



#### Note

See the relevant operating manuals of the D.O. sensors for instructions on maintenance.

#### 5.1.1 Replacing the batteries

1	Unscrew the two screws (1) on the underside of the meter.
2	Open the battery compartment (2) on the underside of the meter.

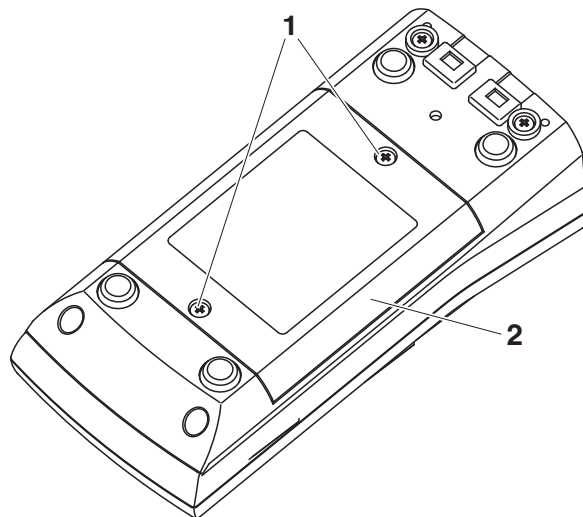

3	Remove the four batteries from the battery compartment.
4	Place four new batteries (type Mignon AA) in the battery compartment.



#### Note

Alternatively, you can also use Ni-MH rechargeable batteries (type Mignon AA). In order to charge the batteries, an external charging device is required.



#### Caution

**Make sure that the poles of the batteries are positioned correctly. The  $\pm$  signs on the batteries must correspond to the  $\pm$  signs in the battery compartment.**

- 5 | Close the battery compartment (2) and tighten the screws (1).

## 5.2 Cleaning

Occasionally wipe the outside of the measuring instrument with a damp, lint-free cloth. Disinfect the housing with isopropanol as required.



### Caution

**The housing is made of synthetic material (ABS). Thus, avoid contact with acetone or similar detergents that contain solvents. Remove any splashes immediately.**

## 5.3 Packing

This meter is sent out in a protective transport packing. We recommend: Keep the packing material. The original packing protects the meter against damage during transport.

## 5.4 Disposal



### Note

This meter contains batteries. Batteries that have been removed must only be disposed of at a recycling facility set up for this purpose or via the retail outlet.

It is illegal to dispose of it in household refuse.



## 6 What to do if...

Error message, <i>OFL</i>	<b>Cause</b> <ul style="list-style-type: none"> <li>– Measured value outside the measuring range</li> </ul>	<b>Remedy</b> <ul style="list-style-type: none"> <li>– Use a suitable D.O. sensor</li> </ul>
Error message, <i>Error</i>	<b>Cause</b> <ul style="list-style-type: none"> <li>– D.O. sensor contaminated</li> </ul>	<b>Remedy</b> <ul style="list-style-type: none"> <li>– Clean D.O. sensor and replace it if necessary</li> </ul>
Sensor symbol flashes	<b>Cause</b> <ul style="list-style-type: none"> <li>– Cleaning interval expired</li> </ul>	<b>Remedy</b> <ul style="list-style-type: none"> <li>– Recalibrate the measuring system</li> </ul>
 Display	<b>Cause</b> <ul style="list-style-type: none"> <li>– Batteries almost empty</li> </ul>	<b>Remedy</b> <ul style="list-style-type: none"> <li>– Replace the batteries (see section 5.1 MAINTENANCE)</li> </ul>
Meter does not react to keystroke	<b>Cause</b> <ul style="list-style-type: none"> <li>– Operating condition undefined or EMC load unallowed</li> </ul>	<b>Remedy</b> <ul style="list-style-type: none"> <li>– Processor reset: Press the <b>&lt;ENTER&gt;</b> and <b>&lt;On/Off&gt;</b> key simultaneously</li> </ul>
You want to know which software version is in the meter	<b>Cause</b> <ul style="list-style-type: none"> <li>– E. g., a question by the service department</li> </ul>	<b>Remedy</b> <ul style="list-style-type: none"> <li>– Switch on the meter. Open the menu, <b>&lt;F1__&gt;</b>/ [Menü] / <i>Speicher &amp; Konfig. / System / Service Information</i>. The instrument data is displayed.</li> </ul>



## 7 Technical data

### 7.1 General data

<b>Dimensions</b>	approx. 180 x 80 x 55 mm	
<b>Weight</b>	approx. 0.4 kg	
<b>Mechanical structure</b>	Type of protection	IP 67
<b>Electrical safety</b>	Protective class	III
<b>Test certificates</b>	CE, cETLus	
<b>Ambient conditions</b>	Storage	- 25 °C ... + 65 °C
	Operation	-10 °C ... + 55 °C
	Allowable relative humidity	Annual mean: < 75 % 30 days/year: 95 % Other days: 85 %
<b>Power supply</b>	Batteries	4 x 1.5 V alkali-manganese batteries, type AA
	Rechargeable batteries	4 x 1,2 V NiMH rechargeable batteries, type AA (no charging function)
	Operational life	up to 800 h without / 100 h with illumination
<b>USB interface</b>	Type	USB 1.1 USB B (device), data output
	Baud rate	adjustable: 1200, 2400, 4800, 9600, 19200 Baud
	Data bits	8
	Stop bits	2
	Parity	None
	Handshake	RTS/CTS
	Cable length	max. 3 m
<b>Guidelines and norms used</b>	EMC	EC directive 2004/108/EC EN 61326-1 EN 61000-3-2 EN 61000-3-3 FCC Class A
	Meter safety	EC directive 2006/95/EC EN 61010-1
	IP protection class	EN 60529

## 7.2 Measuring ranges, resolution, accuracy

### Measuring ranges, resolution

Note: The values quoted in brackets apply especially for the DurOx 325 sensor.

Parameter	Measuring range	Resolution
D.O. concentration [mg/l]	0 ... 20.00 (0 ... 20.0)	0.01 (0.1)
	0 ... 90.0 (0 ... 90)	0.1 (1)
Saturation [%]	0 ... 200.0 (0 ... 200)	0.1 (1)
	0 ... 600	1
D.O. partial pressure [mbar]	0 ... 200.0 (0 ... 200)	0.1 (1)
	0 ... 1250	1
T [°C]	0 ... 50.0	0.1

### Accuracy (± 1 digit)

Parameter	Accuracy
D.O. concentration [mg/l]	± 0.5 % of measured value at ambient temperature + 5 °C ... + 30 °C
Saturation [%]	± 0.5% of measured value when measuring in the range of ± 10 K around the calibration temperature
D.O. partial pressure [mbar]	± 0.5 % of measured value at ambient temperature + 5 °C ... + 30 °C

### T [°C] / temperature sensor

NTC 30	± 0,1
PT 1000	± 0,1

### Correction functions

Temperature compensation	Accuracy better than 2 % at 0 ... + 40 °C
Salinity correction	0 ... 70.0 SAL
Air pressure correction	Automatic through integrated pressure sensor in the range of 500 ... 1100 mbar



### Note

The accuracy values specified here apply exclusively to the meter. The accuracy of the D.O. sensors has also to be taken into account.

**FCC Class A Equipment Statement**

*Note:* This equipment has been tested and found to comply with the limits for a Class A digital device, pursuant to Part 15 of the FCC Rules. These limits are designed to provide reasonable protection against harmful interference when the equipment is operated in a commercial environment. This equipment generates, uses, and can radiate radio frequency energy and, if not installed and used in accordance with the instruction manual, may cause harmful interference to radio communications. Operation of this equipment in a residential area is likely to cause harmful interference in which case the user will be required to correct the interference at his own expense. Changes or modifications not expressly approved by the manufacturer could void the user's authority to operate the equipment.



## 8 Lists

This chapter provides additional information and orientation aids.

**Specialist terms** The glossary briefly explains the meaning of the specialist terms. However, terms that should already be familiar to the target group are not described here.

**Index** The index will help you to find the topics that you are looking for.

### Glossary

<b>Adjusting</b>	To manipulate a measuring system so that the relevant value (e. g. the displayed value) differs as little as possible from the correct value or a value that is regarded as correct, or that the difference remains within the tolerance.
<b>AutoRange</b>	Name of the automatic selection of the measuring range.
<b>Calibration</b>	Comparing the value from a measuring system (e. g. the displayed value) to the correct value or a value that is regarded as correct. Often, this expression is also used when the measuring system is adjusted at the same time (see adjusting).
<b>D.O. partial pressure</b>	Pressure caused by the oxygen in a gas mixture or liquid.
<b>D.O. saturation</b>	Short name for the relative D.O. saturation.
<b>Measured parameter</b>	The measured parameter is the physical dimension determined by measuring, e. g. pH, conductivity or D.O. concentration.
<b>Measured value</b>	The measured value is the special value of a measured parameter to be determined. It is given as a combination of the numerical value and unit (e. g. 3 m; 0.5 s; 5.2 A; 373.15 K).
<b>OxiCal®</b>	WTW name for a procedure to calibrate D.O. measuring systems in water vapor saturated air.
<b>Reset</b>	Restoring the original condition of all settings of a measuring system.
<b>Resolution</b>	Smallest difference between two measured values that can be displayed by a meter.

<b>Salinity</b>	The absolute salinity $S_A$ of seawater corresponds to the relationship of the mass of dissolved salts to the mass of the solution (in g/Kg). In practice, this dimension cannot be measured directly. Therefore, the practical salinity according to IOT is used for oceanographic monitoring. It is determined by measuring the electrical conductivity.
<b>Salt content</b>	General designation for the quantity of salt dissolved in water.
<b>Slope (relative)</b>	Designation used by WTW in the D.O. measuring technique. It expresses the relation of the slope value to the value of a theoretical reference sensor of the same construction type.
<b>Stability control</b>	Function to control the measured value stability.
<b>Test sample</b>	Designation of the test sample ready to be measured. Normally, a test sample is made by processing the original sample. The test sample and original sample are identical if the test sample was not processed.



**Index****A**

Air calibration beaker	30
Authorized use	10
Automatic switch-off	15
AutoRead	27

**B**

Battery compartment	13, 47
---------------------	--------

**C**

Calibration evaluation	31
Calibration records	33
Comparison measurement (D.O.)	30
Connecting a PC	43

**D**

Dataset	35
Date and time	21
Default settings	
Measured parameter	44
System settings	45

**E**

Energy saving feature	14
Energy saving mode	38

**F**

Firmware update	59
-----------------	----

**I**

Initial commissioning	13, 14
Initialize	44

**K**

Keys	6
------	---

**M**

Measured value display	17
Measurement data storage	
Edit	39
Erase	39
Storage locations	35
Measurement dataset	35

Measuring	26
Menu for calibration and measurement settings	28
Menus (navigation)	17
Messages	18

**O**

Operational safety	10
--------------------	----

**P**

Precautions	9
Print	42

**R**

Reset	44
-------	----

**S**

Safety	9
Sample display	7
Saving	35
At intervals	37
Automatic	37
Manual	36
Scope of delivery	13
Setting the date	14
Setting the time	14
Slope relative	30
Socket field	8
Stability control	
Automatic	24
Storage interval	37

**T**

Temperature measurement	25
Transmitting data	42
Transmitting measured values	42



## Appendix: Firmware update

### General information

Available firmware updates are provided on the Internet. With the "Firmware Update " program and a PC you can update the firmware of the Oxi 3310 to the newest version.

For the update you have to connect the meter to a PC.

For the update via the USB interface, the following is required:

- a free USB interface (virtual COM port) on the PC
- the driver for the USB interface (on the enclosed CD-ROM)
- the USB cable (included in the scope of delivery of the Oxi 3310).

### Program installation

1	Install the downloaded firmware update on a PC.  An update folder is created in the Windows start menu. If an update folder already exists for the meter (or meter type), the new data is displayed there.
---	--

### Program start

2	In the windows start menu, open the update folder and start the firmware update program.
---	--

### Firmware update

3	Using the USB interface cable, connect the Oxi 3310 to a USB interface (virtual COM port) of the PC.
4	Switch on the Oxi 3310.
5	In the firmware update program, start the update process with OK.
6	Follow the instructions of the firmware update program. During the programming process, a corresponding message and a progress bar (in %) are displayed. The programming process takes approx. three minutes. A terminatory message is displayed after a successful programming process. The firmware update is completed.
7	Disconnect the Oxi 3310 from the PC. The Oxi 3310 is ready for operation again.

After switching the meter off and on you can check whether the meter has taken over the new software version (see page 49).







## **Wissenschaftlich-Technische Werkstätten GmbH**

Dr.-Karl-Slevogt-Straße 1  
D-82362 Weilheim

Germany

Tel:           +49 (0) 881 183-0  
               +49 (0) 881 183-100  
Fax:           +49 (0) 881 183-420  
E-Mail:        Info@WTW.com  
Internet:      <http://www.WTW.com>