

# GroLine

HI981420

HI981421

GROLINE MONITOR



INSTRUCTION MANUAL

 HANNA<sup>®</sup>  
instruments

Dear  
Customer,

Thank you for choosing a Hanna Instruments product.

Please read this instruction manual carefully before using the instrument.

This manual will provide you with the necessary information for correct use of the instrument, as well as a precise idea of its versatility.

If you need additional technical information, do not hesitate to e-mail us at [tech@hannainst.com](mailto:tech@hannainst.com) or view our worldwide contact list at [www.hannainst.com](http://www.hannainst.com).

*All rights are reserved. Reproduction in whole or in part is prohibited without the written consent of the copyright owner, Hanna Instruments Inc., Woonsocket, Rhode Island, 02895, USA.*

1. PRELIMINARY EXAMINATION .....	4
2. SAFETY MEASURES .....	4
3. SPECIFICATIONS .....	5
4. DESCRIPTION .....	8
4.1. SIGNIFICANCE OF USE .....	8
4.2. GENERAL DESCRIPTION .....	10
4.3. PRODUCT DIAGRAM .....	11
4.4. KEYPAD DESCRIPTION .....	12
5. GENERAL OPERATIONS .....	13
5.1. STARTING UP THE MONITOR .....	13
5.2. CONNECTING THE PROBE .....	14
5.3. INLINE MOUNTING RECOMMENDATIONS.....	16
5.4. TANK MOUNTING RECOMMENDATIONS.....	17
5.5. ELECTRODE CONDITIONING AND MAINTENANCE .....	19
5.6. MONITOR MENU .....	21
5.6.1. MENU OPTIONS .....	21
5.6.2. GENERAL SETUP.....	23
5.6.3. pH SETUP .....	26
5.6.4. EC SETUP .....	28
5.6.5. TEMPERATURE SETUP .....	29
5.6.6. ALARMS .....	31
6. OPERATIONAL GUIDE .....	32
6.1. PROBE CALIBRATION .....	32
6.1.1. QUICK CALIBRATION .....	32
6.1.2. pH CALIBRATION .....	33
6.1.3. EC CALIBRATION .....	35
6.2. GLP INFORMATION .....	38
6.3. MEASUREMENT MODE .....	39
7. DATA STORAGE .....	42
7.1. 24 HR. DATA FROM MEASUREMENT SCREEN .....	42
7.2. HISTORY .....	42
7.3. DATA EXPORT .....	44
8. ACCESSORIES .....	46

## 1. PRELIMINARY EXAMINATION

This product is intended to monitor pH and conductivity levels in nutrient water. Remove the instrument and accessories from the packaging and examine it carefully to make sure that no damage has occurred during shipping. Remove the protective film from the **Monitor**. Notify your nearest Hanna Instruments Customer Service Center if damage is observed.

Each **HI981420** is delivered in a cardboard box and is supplied with:

- **HI981420 Groline Monitor**
- **HI1285-8** pH/EC/TDS probe with built-in temperature sensor, DIN connector and 2 m (6.6') cable
- **HI50036** Quick calibration solution (2 sachets)
- **HI700661** Electrode cleaning solution for agriculture (2 sachets)
- 12VDC adapter
- Instruction manual
- Monitor quality certificate
- Probe quality certificate
- Quick start instruction guide

Each **HI981421** is delivered in a cardboard box and is supplied with:

- **HI981420 Groline Monitor**
- **HI1285-9** Triple junction inline pH/EC/TDS probe with built-in temperature sensor, 3/4" NPT threaded body, DIN connector and 3 m (9.8") cable
- **HI50036** Quick calibration solution (2 sachets)
- **HI700661** Electrode cleaning solution for agriculture (2 sachets)
- 12VDC adapter
- Instruction manual
- Monitor quality certificate
- Probe quality certificate
- Quick start instruction guide

*Note: Save all packing material until you are sure that the instrument works correctly. Any damaged or defective item must be returned in its original packing material with the supplied accessories.*

## 2. SAFETY MEASURES



Before using this product, make sure that it is entirely suitable for your specific application and for the environment in which it is used.



Operation of this instrument may cause interference to other electronic equipment, requiring the operator to take steps to correct interference. Any variation introduced by the user to the supplied equipment may degrade the monitor's EMC performance.



To avoid damage or burns, do not put the instrument in microwave ovens.  
Do not use or store the monitor in hazardous environments.

### 3. SPECIFICATIONS

#### pH specifications

Range	0.00 to 14.00 pH, 0.0 to 14.0 pH*
Resolution	0.01 pH, 0.1 pH
Accuracy (@25 °C/77 °F)	±0.05 pH, ±0.1 pH
Calibration	one or two-point calibration (using pH 4.01, 7.01, 10.01 buffers) using auto buffer recognition one-point calibration using quick calibration solution
Temperature compensation	automatic: 0.0 to 60.0 °C; 32.0 to 140.0 °F

#### EC specifications

Range	0.00 to 10.00 mS/cm
Resolution	0.01 mS/cm
Accuracy (@25 °C/77 °F)	±0.10 mS/cm (0.00 to 5.00 mS/cm) ±0.20 mS/cm (5.00 to 10.00 mS/cm)
Calibration	one-point at 1.41 mS/cm or 5.00 mS/cm using auto standard recognition. one-point calibration using quick calibration solution
Temperature compensation (not user selectable)	automatic, with $\beta = 1.9\%/^{\circ}\text{C}$

#### TDS specifications

Range	0 to 5000 ppm (0.5 TDS Factor)** 0 to 7000 ppm (0.7 TDS Factor)**
Resolution	10 ppm
Accuracy (@25 °C/77 °F)	±2% FS
Calibration	through EC calibration
TDS factor	0.5 (500 ppm) or 0.7 (700 ppm)

\*Note: pH range will be reduced to actual probe specification

\*\* Note: 1000  $\mu\text{S}/\text{cm} = 500 \text{ ppm}$  with 0.5 TDS Factor  
= 700 ppm with 0.7 TDS Factor

## Temperature specifications

Range	0.0 to 60.0 °C / 32.0 to 140.0 °F
Resolution	0.1 °C / 0.1 °F
Accuracy	±0.5 °C / ±1.0 °F

## Additional specifications

Automatic logging	Measurements (pH, EC, TDS, temperature) Min/Max/average/status logged continuously at 15 minutes interval
	Recall graphic modes
	Export on USB-C flash drive or PC
	Log files in CSV format
	30 days stored data at 15 minutes interval
Display	128 x 64 pixel B/W LCD with green backlight
	Automatic backlight dimming using ambient light sensor
GLP	Good Laboratory Practice with last 5 pH and EC calibration history
Monitor protection rating	IP65 (dust and low pressure water jets)
Alarms	High and Low with enable/disable option for all parameters
USB-C (Host/Device)	Export logged data on USB flash drive / PC
Power supply	12VDC adapter (included)
Environment	0 to 50 °C (32 to 122 °F), RH max 95% non-condensing
Monitor dimensions	125 x 185 x 38 mm (4.92 x 7.28 x 1.49")
Monitor weight	333 g (11.7 oz.)
Ordering information	<p>HI981420 is supplied with: HI1285-8 multiparameter probe, HI50036 Quick cal buffer solution (2 sachets), HI700661 pH electrode cleaning solution for agriculture (2 sachets), DC power adapter (1) and instruction manual. HI981420-01 with US plug, HI981420-02 with EU plug</p> <p>HI981421 is supplied with: HI1285-9 inline multiparameter probe, HI50036 Quick cal buffer solution (2 sachets), HI700661 pH electrode cleaning solution for agriculture (2 sachets), DC power adapter (1) and instruction manual. HI981421-01 with US plug, HI981421-02 with EU plug</p>
Warranty	GroLine Monitor is warranted for a period of 2 years

## Probe specifications

Probe	HI1285-8	HI1285-9
Description	Preamplified pH/EC/Temp probe	Preamplified inline pH/EC/Temp probe
Reference	Single junction Ag/AgCl	Triple internal junction Ag/AgCl
Junction	Cloth	PTFE
Electrolyte	Gel	Polymer
Max. pressure (25 °C)	0.2 bar	8.0 bar
pH range	0.00 to 13.00 pH	0.00 to 12.00 pH
pH tip shape	Spherical (dia: 6.0 mm)	Spherical (dia: 5.5 mm)
Amplifier	Yes	
EC range	0.00 to 10.00 mS/cm	
EC electrodes	2 x graphite	
Temp. range	0.0 to 50.0 °C (32.0 to 122.0 °F)	0.0 to 60.0 °C (32.0 to 140.0 °F)
Temp. sensor	Yes	
Body material	Polypropylene	PVC (thread 3/4" NPT)
Cable	8 pole; 2 m cable (6.6")	8 pole; 3 m cable (9.8")
Protection rating	IP68 (continuous immersion up to 2 m)	IP68 (continuous immersion up to 3 m)
Recommended use	hydroponics, aquaponics, greenhouses	
Connection	DIN (to be used with HI981420 <a href="#">GroLine Monitor</a> )	
Probe dimensions	187 x 25 mm (7.36 x 0.98")	190 x 32 mm (7.48 x 1.25")
Probe weight	191 g (7.7 oz.)	265 g (9.3 oz.)
Warranty	Probes are warranted for a period of 6 months	

## 4. DESCRIPTION

### 4.1. SIGNIFICANCE OF USE

#### pH in agriculture

pH affects the ability of plant roots to absorb nutrients. Calcium, phosphorus, potassium and magnesium are likely to be unavailable to plants in acidic soils. Plants have difficulty absorbing copper, zinc, boron, manganese and iron in basic soils. By managing pH, you can create an ideal environment for plants and often discourage plant pests at the same time.

pH is measured on a scale of 0-14. A pH reading below 7 is considered acidic, while a pH reading above 7 is basic. A pH reading of 7 is neutral, and is ideal for many plants and spray materials.

The pH scale is logarithmic, which means that a pH reading of 6 is 10 times more acidic than a reading of 7.

You can measure the pH of your spray tank water, or your irrigation/fertigation water.

If spray tank water is too acidic (low pH) or too basic (high pH), the pesticides mixed in can be deactivated and may even burn the plants.

The pH of water applied to the plants should match the desired soil pH, otherwise it will gradually change the pH of the soil. Acidic fertilizers can be used to lower pH. Limestone is often used to raise pH. The type of limestone applied and your soil type can make a difference in how quickly and how much the pH will change. Most of the nitrogen and phosphorus fertilizers used today are acid forming. For example, about 1.5 pounds of lime is required to neutralize the effect of applying 1 pound of anhydrous ammonia to the soil.

Irrigation water may contain substantial quantities of calcium and magnesium bicarbonates (lime) which help neutralize the acidifying effects. Thus, soils (without free lime) under production become increasingly acidic unless lime is artificially applied or is present in the irrigation water. This means farmers need to frequently check soil pH to determine whether they are maintaining a proper soil acidity level.



## EC in agriculture

EC stands for electrolytic conductivity, or the ability of a solution to conduct an electric current. Current travels efficiently through water with high levels of salt present (high EC), and less so through pure water (low EC). EC indicates how much dissolved salt is in a given sample. That's why EC is also referred to as TDS (total dissolved solids). All nutrients are salts, so EC is a measure of your total nutrients. Knowing your EC levels will help in plant production and monitoring of inputs. Monitoring the EC of aqueous solutions is fairly simple.

Calibrate the probe in a known standard and then submerge the sensor into the liquid.

To use EC to check fertilizer levels, take an EC reading of a precise mixture of your fertilizer and irrigation water in the desired concentration. You can check your fertigation water at any point along the system. Its EC should match your samples. If it doesn't, check the injectors, valves and nozzles for blockage or other problems.

To determine your fertilizer concentration check the EC of your water first and then subtract that number from the EC reading of your solution.

Another way to determine the output of your fertilizer injector is by measuring the electrical conductivity (EC) of the diluted fertilizer solution. By using an EC meter and measuring the EC of the solution you can get a good estimate of the fertilizer concentration.

Be sure to calibrate your monitor before use and be sure to subtract the EC of your clear water from the fertilizer reading. Compare the corrected value for the EC of your fertilizer solution to that listed on the fertilizer bag for the ppm N you intend to apply.

During the crop cycle, especially for short-term crops like bedding plants, you should monitor the EC of your fertilizer solution to check that the injector is working properly. The fertilizer label may have the EC of several concentrations of the diluted fertilizer.

For example, the EC of 100 ppm N, is 0.65 mS/cm.

## 4.2. GENERAL DESCRIPTION

GroLine Monitor is designed to offer you the combination of pH, conductivity (or total dissolved solids) with temperature measurements. All operations and settings, including calibration buffers and temperature scale selection, are included in a easy to use Monitor setup.

The supplied HI1285-8 (with HI981420) or HI1285-9 (with HI981421) multiparameter probe measures pH, EC/TDS and temperature in one convenient, rugged probe. A solid-state preamplifier is integrated into the probe to protect the pH measurement from transient electrical noise. Sources of electrical noise include ballasts used in lighting and pumps to circulate water and nutrient solutions. If pH reading in pH 7.01 buffer is around 4.01, the probe is broken.

Measurements are automatically logged in the GroLine Monitor internal memory every 15 minutes and can be viewed using the plot/record log feature or exported to a Flashdrive, or by connecting to a PC.

The three main operating modes of this Monitor are measurement, setup and logging. Follow this general outline to get you started. The following topics are expanded in the sections of this manual.

Other features include:

- can be integrated into a fertilizer system
- pH/EC/TDS probe with built-in temperature sensor
- as a failsafe feature, if the pH bulb breaks, the pH will be around 4.01
- multiple viewing options for on-screen data
- quick calibration using Quick cal solution for pH and EC simultaneously
- pH and EC calibration timeout reminder (1-30 days)
- visual plot screens for real-time data and log history
- 24 hours summary screens (plot and details)
- alarms feature for all parameters
- automatic continuous logs, 15 minutes intervals, 30 days storage
- logged data can be stored and later exported to a USB C drive or transferred to a PC using USB C connection
- GLP feature calibration data for pH and EC (up to 5 calibrations)
- dedicated help with contextual message
- setup, calibration and operating parameters are stored in nonvolatile memory (important to note that if power is lost all settings are retained)
- probe inline mounting for fast measurement feedback (HI1285-9 only)
- ambient light sensor for ON/OFF backlight

## 4.3. PRODUCT DIAGRAM

## FRONT VIEW

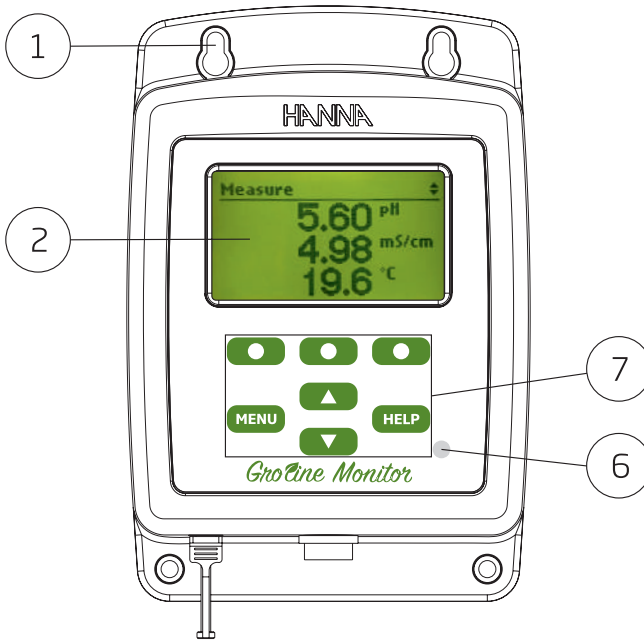

## BOTTOM VIEW

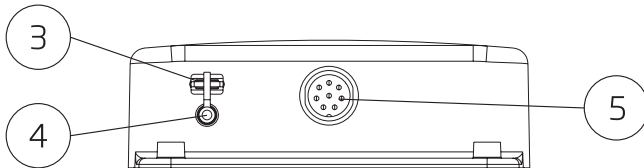

1. Mounting holes
2. Liquid Crystal Display (LCD)
3. USB C port
4. Power cable
5. DIN probe connector
6. Ambient light sensor
7. Keypad area

## BACK VIEW

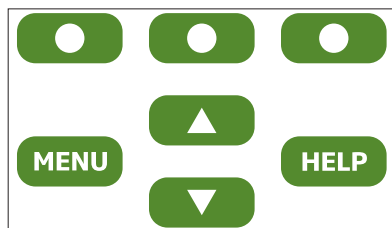

## 4.4. KEYPAD DESCRIPTION

**MENU**

access to Quick calibration, logged history, pH/EC/temperature options and General setup

▲

in menu mode scroll the menu items /adjust the settings

▼

in measurement mode changes the screen: three parameter screen (pH, EC and temperature), single parameter screen and plot display

**HELP**

enter/exit help menu

●

virtual function keys - contextual functionality

## 5. GENERAL OPERATIONS

### 5.1. STARTING UP THE MONITOR

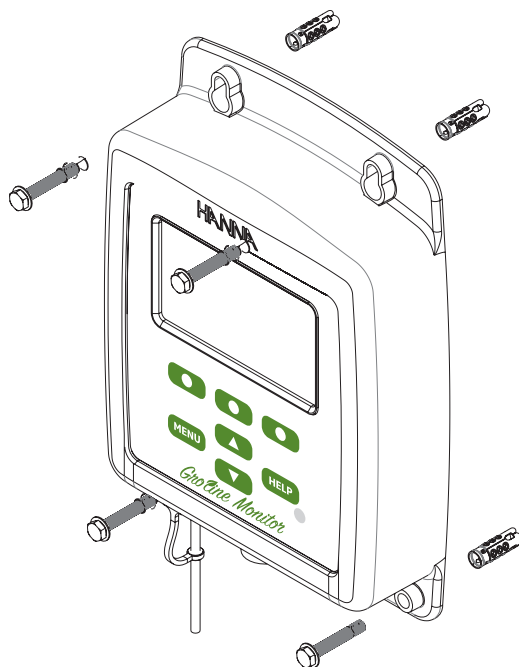

Detailed below is a general outline of the steps required to perform accurate measurements.

1. Mount the **Monitor** on a stable support wall.
2. Connect the **HI1285-8** or **HI1285-9** probe to the **Monitor**.
3. Connect the power adapter to the **Monitor** and switch it on.
4. Set up the **Monitor**. See the "Monitor MENU" section for details.
5. Calibrate the probe.

#### Mounting the Monitor

The **HI981420** is supplied with mounting holes in the enclosure. Utilizing all the mounting holes, it should be wall mounted at eye-level, on a vibration-free surface. When choosing installation location consider power source, tank location (with regard to length of sensor cable) and operating temperature (50 °C/122 °F maximum).

The GroLine Monitor and probe can be used for fertilizer tank monitoring. The system continuously measures the EC and pH of the tank.

The probe (HI1285-8 or HI1285-9) should be placed in a location representing the bulk properties of the tank.

## 5.2. CONNECTING THE PROBE

### HI1285-8

With the monitor turned off, connect the HI1285-8 probe to the DIN socket on the bottom of the monitor by aligning the pins and pushing in the plug. Tighten the nut to ensure a good connection. Remove the protective cap from the probe before taking any measurements.

Do not be alarmed if salt deposits are present!

This is normal with electrodes and they will disappear when rinsed with water.

### PROBE DESCRIPTION

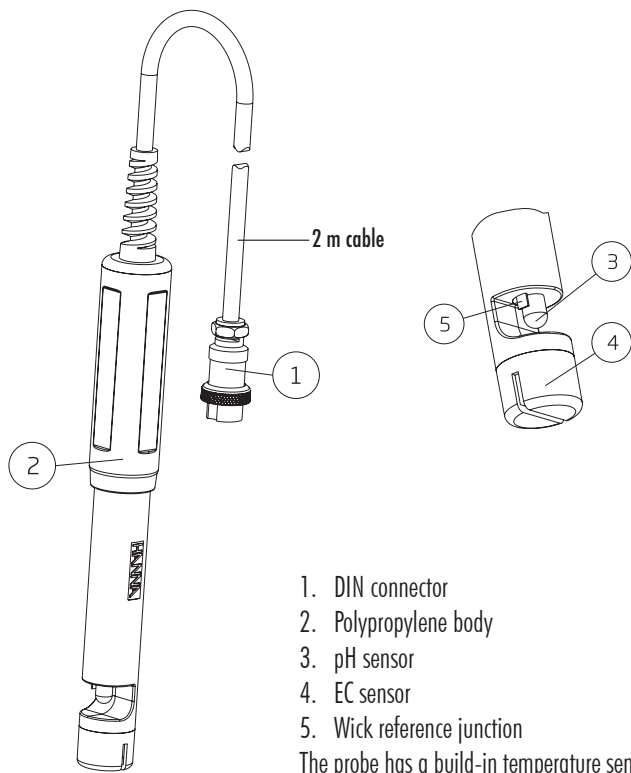

1. DIN connector
2. Polypropylene body
3. pH sensor
4. EC sensor
5. Wick reference junction

The probe has a build-in temperature sensor.

## HI1285-9

With the monitor turned off, connect the HI1285-9 probe to the DIN socket on the bottom of the monitor by aligning the pins and pushing in the plug. Tighten the nut to ensure a good connection. Remove the protective cap from the probe before taking any measurements.

Please note that the probe needs to be calibrated before installing in a pipe line or tank.

Do not be alarmed if salt deposits are present!

This is normal with electrodes and they will disappear when rinsed with water.

## PROBE DESCRIPTION

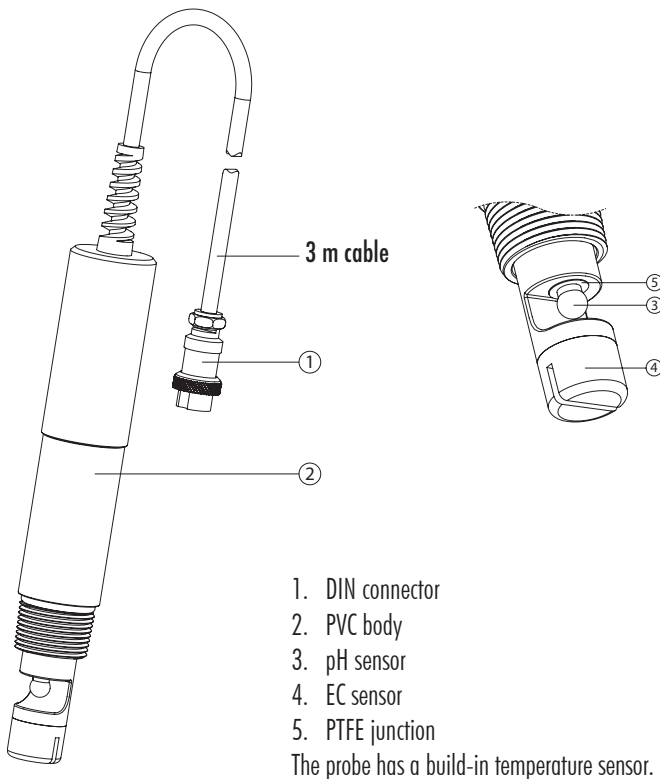

### 5.3. INLINE MOUNTING RECOMMENDATIONS

Verify the maximum pressure of your circuit before mounting the probe. Ensure that the pressure does not exceed 8 bars. Prepare the circuit with 3/4 NPT threaded T-junction so that the probe can be mounted. Recommended pipe size is 2".

Perform a test measurement before inline mounting the probe to verify its functionality. If necessary, also perform probe calibration (see section 6, [OPERATIONAL GUIDE](#)).

After ensuring that the probe measures correctly, power off the [Monitor](#) and disconnect the probe.

Ensure the gasket for sealing the circuit has already been mounted on the probe's body. Mount the probe by tightening in place to ensure a good connection. Recommended tilt angle is between 30 and 45 degrees from vertical position for better liquid flow around the probe pH sensor and to prevent the electrodes being in an air pocket. Connect the probe to the [Monitor](#).

After the probe has been assembled, fill the circuit with liquid fertilizer (or water) and check if there are any leaks. To ensure correct measurement it is recommended that the tip of the probe is submersed approximately 38mm inside the pipe. Both EC and pH sensors must be fully immersed in liquid.

For better measurements it is recommended to mount the probe in circuit before recirculation pump.



Mounting and dismantling the probe must be done with the probe disconnected from the [Monitor](#).

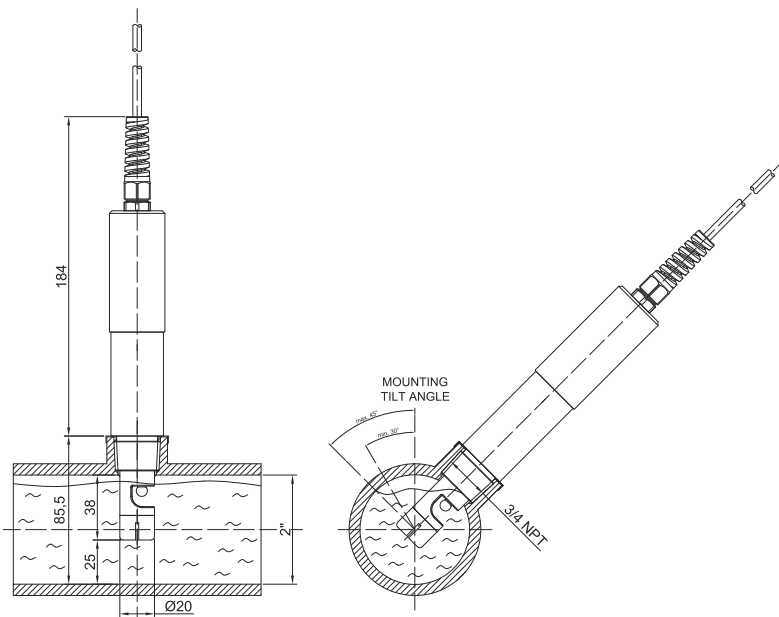



## 5.4. TANK MOUNTING RECOMMENDATIONS

The electrode can be mounted inside the water tank using **HI60501** special immersion electrode holder. In order to do this mounting check if your water tank is compatible with this particular immersion electrode holder.

For assembly please follow steps detailed below:

- remove the rubber part from the cable locking system and cut the external wall as shown in image below.

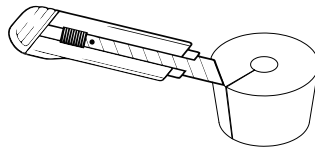

- mount the rubber part on the probe cable.

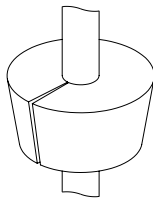

- attach the mounting flange **HI605011** to the tank with 4 screws (not included); see below sketch for tank preparation before mounting.

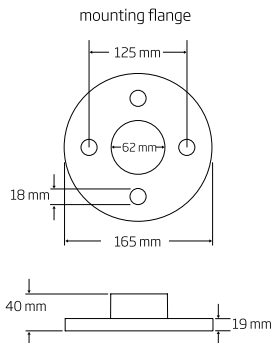

- mount the probe as shown in detailed sketch:

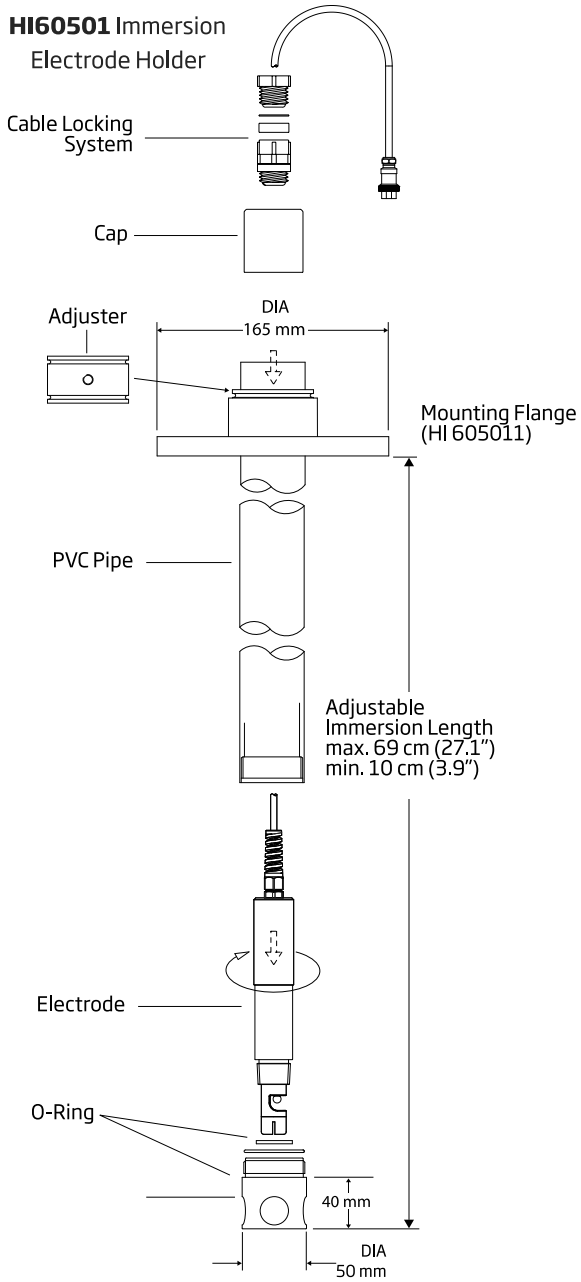

## 5.5. ELECTRODE CONDITIONING AND MAINTENANCE

Tiny air bubbles may form inside the pH sensor bulb during transport. The electrode cannot function properly under these conditions. Remove the bubbles by “shaking down” the electrode as you would do with a glass thermometer. If the pH bulb and/or junction are dry, soak the probe in HI70300 Storage solution for at least one hour.

To ensure a quick pH response, the glass bulb and the junction should be kept moist and not allowed to dry out. Install the probe so it is constantly immersed in the sample.

When not in use, keep the glass hydrated by moistening the small sponge with HI70300 Storage solution or HI7082 KCl 3.5M, and replace the protective cap.

**IMPORTANT:** Rinse the entire probe with tap water and shake excess water off before use. The Storage solution is extremely conductive and will contaminate standards if not thoroughly removed.

### pH bulb cleaning and inspection

1. As preventative maintenance measure, rinse the probe with tap water on a weekly basis. Inspect probe to ensure solids have not caked around the bulb. A thorough cleaning is advised to be performed bimonthly. Clean the entire HI1285-8 (HI1285-9\*) probe in HI700661 Electrode cleaning solution for agriculture.
2. Open the HI700661 sachet. Place the sachet in a beaker to prevent tipping. Place the probe in the sachet and stir the solution gently. Allow the probe to soak in the sachet for 5 to 15 minutes. Rinse the entire probe thoroughly with water.
3. Shake excess water from the probe.
4. Soak the probe for 1 hour in HI70300 storage solution. Rinse the entire probe thoroughly with water after this procedure, as the Storage solution is extremely conductive.
5. Shake excess water from the probe.
6. Recalibrate: place the probe tip into the pH calibration standard. Wait for the reading to stabilize as the probe equilibrates to the temperature of the solution.
7. If the probe response is slow or does not calibrate correctly, repeat the cleaning procedure.

\*For HI1285-9 the maintenance routine can vary depending on specific application requirements and constraints. If the probe is inline mounted and the maintenance routine can not be easily performed on a weekly basis, it is recommended to be performed as frequent as the specific application requires it.

If the probes are used for difficult samples (which can clog the probe) it is recommended to perform frequent maintenance routines.

If the probes are used for applications which require high accuracy, it is again recommended to perform frequent calibrations and cleanings.

### EC Cell cleaning and inspection

1. As preventative maintenance measure, rinse the probe with tap water on a weekly basis. Monthly, a more thorough cleaning is advised. Clean the EC sensor (slot in bottom of probe) with a non-abrasive detergent, or, alternatively, refer to cleaning step 4 below.
2. Inspect the slot at the bottom of the probe. It should be free of foreign material.
3. If any solids are detected in the slot, use a soft material such as cardboard, to dislodge the material. Pass the material through the slot repeatedly.
4. Salt or mineral coating can be removed by rinsing it under a stream of running tap water and jetting the stream through the opening. During pH cleaning, the EC probe will also be exposed to pH cleaning solutions. This solution will also help dissolve coating on the EC sensors. Rinse the slot thoroughly with water after this procedure, as it is extremely conductive.
5. Shake excess water from the probe.
6. Recalibrate: place the probe tip into EC calibration standard. Wait for the reading to stabilize as the probe equilibrates to the temperature of the solution. Press GLP and note the cell coefficient.

## 5.6. MONITOR MENU

### 5.6.1. MENU OPTIONS

Press **MENU** key to display a list of configurable options. Highlight the desired option using ▲ ▼.

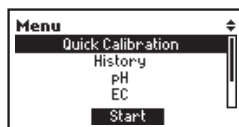

### Quick Calibration

Press **Start** to enter the **Quick Calibration** screen. pH and Conductivity are displayed and the quick calibration procedure is initiated (see Operational guide).

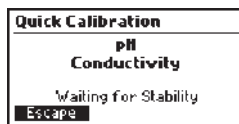
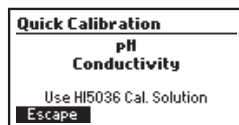

### History

When **History** is selected, two options are available: **View** and **Options**. By using these options, the user can view data, plot or export data (see Data Storage).

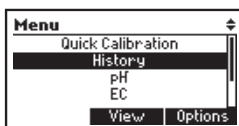

### pH

Three **pH** options are available: **CAL**, **Setup**, and **GLP**.

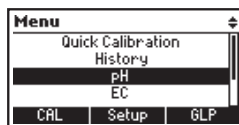

1. Press **CAL** to start a standard pH calibration procedure (see pH calibration).

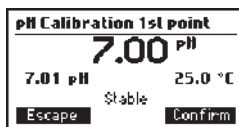

2. Press **Setup** to enter in **Menu/pH** options.

**High** and/or **Low pH alarm** can be selected. Calibration timeout feature can be configured and pH resolution can be changed from 0.01 to 0.1 pH.

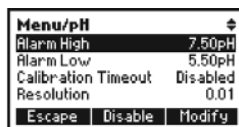

3. Press **GLP** to display the last pH calibration data and up to four previous ones. Use ▲ ▼ to display previous Calibration data. The newest data is in position 1.

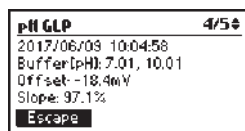

### EC

Three options are available after pressing **EC**: **CAL**, **Setup** and **GLP**.

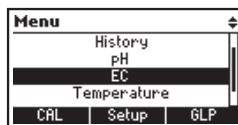

1. Press **CAL** to initiate a EC calibration with a conductivity standard (see EC calibration).



2. Press **Setup** to enter parameters menu (see EC Setup) used to configure conductivity measurements. These include alarms, calibration timeout feature, mode and TDS factor.

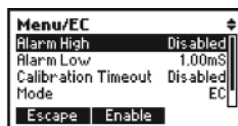

3. Press **GLP** to display the last EC calibration data and up to four previous calibrations. Use ▲ ▼ arrow to display previous calibration data. The newest data is in position 1.

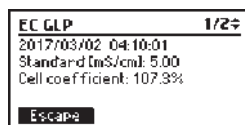

### Temperature

Highlight **Temperature** and press **Setup** to display temperature options menu (see Temperature Setup).

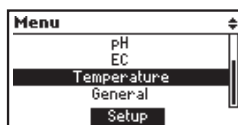

### General

Highlight **General** and press **Setup** to enter General options menu (see General setup).

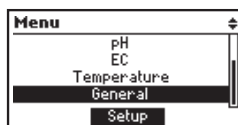

## 5.6.2. GENERAL SETUP

### Backlight

Default state is **Auto** (in low-light conditions backlight level is automatically adjusted to dim). This function, together with the integrated ambient sensor on the keypad, works to automatically adjust the backlight of the LCD.

Press **Auto** and then **Modify** to adjust the minimum backlight intensity level. If the minimum level changes when the room is dark, the backlight remains ON at lower brightness. The range is 0-50%.

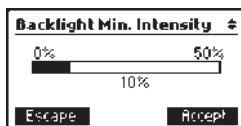
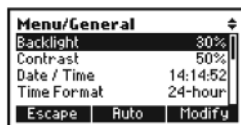

Press **Manual** and then **Modify** to change backlight value from 0 to 100% using ▲ ▼ arrows.

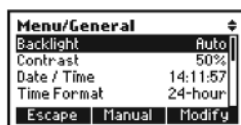

Press the **Accept** key to confirm or **Escape** to return to the general menu without saving the new value.

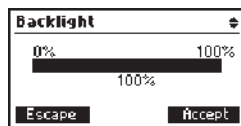

### Contrast

Press **Modify** to change contrast value from 0 to 100% using ▲ ▼ arrows. Press the **Accept** key to confirm or **Escape** to return to the general menu without saving the new value.

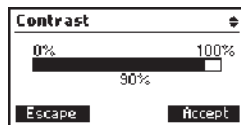
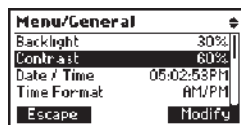

## Date / Time

Press the **Modify** key to change the date/time.

Press the functional **▶** key to highlight the value to be modified (year, month, day, hour, minute or second). Use the **▲ ▼** keys to change the value.

Press the **Accept** key to confirm changes or **Escape** to return to general menu without saving the new date or time.

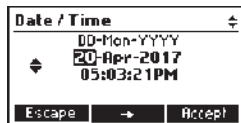
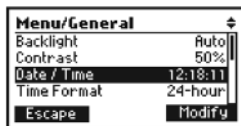

*Note: If time is changed to a value before the last log, a time conflict warning will be displayed and logs will be erased.*

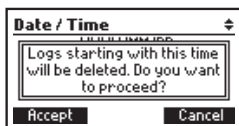

## Time Format

**Option:** AM/PM or 24-hour

Press the functional key to select the desired time format.

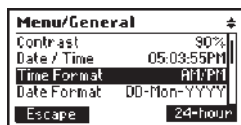

## Date Format

Press the **Modify** key to change the Date format.

Use the **▲ ▼** keys to select the desired format.

Press the **Accept** key to confirm or **Escape** to return to general menu without saving the new format.

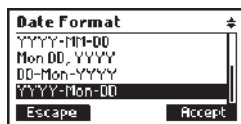
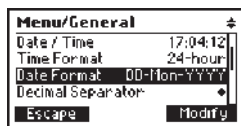



## Decimal Separator

**Option:** Comma ( , ) or Period ( . )

Press the functional key to select the desired decimal separator or press **Escape** to return to general menu without saving the new format. The decimal separator is used on the measurement screen and CSV files.

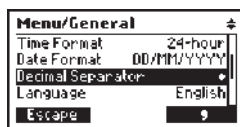

## Language

Press the Modify key to change the language. Use the ▲ ▼ keys to select the desired language. Press the **Accept** key to confirm or **Escape** to return to general menu.

Press the functional key to select one of the languages installed.

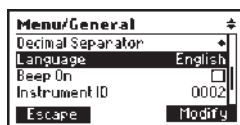

## Beep On

**Option:** Enable or Disable

When enabled, a short beep is heard every time a key is pressed. A long beep alert sounds when the pressed key is not active or an error is detected. Press the functional key to enable/disable the beeper.

Press **Escape** to return to the general menu.

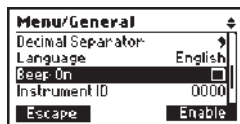

## Instrument ID

**Option:** 0 to 9999

This option is used to set the instrument's ID (identification).

Press the **Modify** key to access the instrument's ID screen.

Press the ▲ ▼ keys in order to set the desired value.

Press the **Accept** key to confirm the value or **Escape** to return to the general menu without saving the new value.

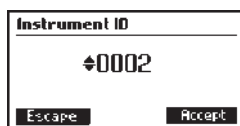
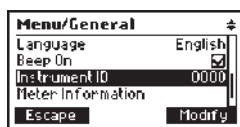

*Note: This ID will be used in data files exported from the Monitor.*

### Meter Information

Press the **Select** key to view the model, serial number, firmware version and selected language. Press **Escape** to return to the general menu.

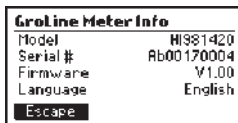
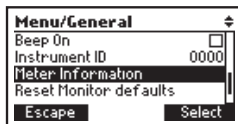

### Reset Monitor defaults

Press the **Select** key to activate Reset Monitor defaults settings. Press **Accept** to initiate procedure or **Cancel** to return to the general menu without reset.

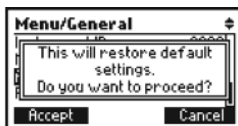
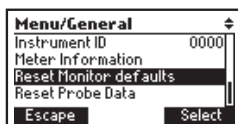

### Reset Probe Data

Use this feature when replacing the probe. This function erases the previous probe's GLP history and calibration data.

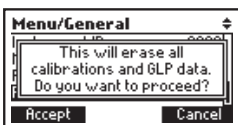
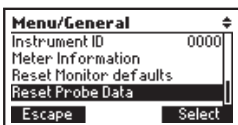

### 5.6.3. pH SETUP

**Alarm High** and **Alarm Low** in the pH menu have two options **Enable** or **Disable**:

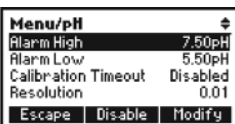
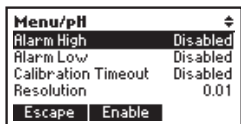

With alarms set to **Enable**, press **Modify** to adjust the pH alarm value.

Set the **Alarm Low** and **Alarm High** as boundaries of acceptable pH variation. If these boundaries are exceeded, the display flashes as a visual indication that the pH of the desired solution has changed.

Menu/pH	
Alarm High	7.50pH
Alarm Low	5.50pH
Calibration Timeout	Disabled
Resolution	0.01
Escape Disable Modify	

Menu/pH	
Alarm High	Disabled
Alarm Low	1.93pH
Calibration Timeout	Disabled
Resolution	0.01
Escape Disable Modify	

Use ▲▼ keys to set pH alarm value.

Press the **Accept** key to confirm the value or **Escape** to return to the general menu without saving the new value.

Alarm Low	
◆ 1.61 pH	
Escape Accept	

Alarm High	
◆ 9.59 pH	
Escape Accept	

*Note: The high alarm must be set to a value greater than the low alarm.*

### Calibration Timeout

**Calibration Timeout** feature is used to set a calibration or service reminder. This can be configured from 1-30 days or disabled. A message will be displayed with the measurement indicating it's time to service the probe.

Menu/pH	
Alarm High	Disabled
Alarm Low	Disabled
Calibration Timeout	7 days
Resolution	0.01
Escape Disable Modify	

Calibration Timeout	
◆ 30 days	
Escape Accept	

pH Clean/Cal. Due	
7.08 pH	
4.62 mS/cm	
25.0 °C	

### Resolution

Press functional key to choose desired pH resolution (0.01 or 0.1).

Press **Escape** to return to the general menu.

Menu/pH	
Alarm High	Disabled
Alarm Low	Disabled
Calibration Timeout	Disabled
Resolution	0.01
Escape	0.1

### 5.6.4. EC SETUP

*Note: Prior to setting EC alarm limits, select desired Mode of operation, TDS or EC.*

Alarm High and Alarm Low in the EC menu have two options, Enable or Disable.

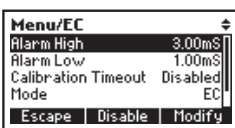
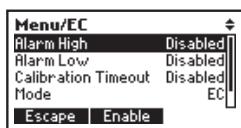

When alarms are set to **Enable** press **Modify** to adjust EC alarm value.

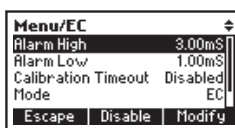
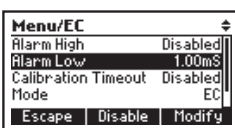
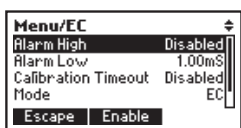

Use ▲▼ keys to set EC alarm value.

Press the **Accept** key to confirm the value or **Escape** to return to the general menu without saving the new value.

*Note: The high alarm must be set to a value greater than the low alarm.*

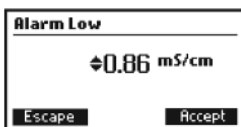
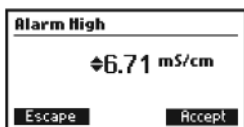

When selected measurement mode is TDS, alarms values will be displayed in ppm units.

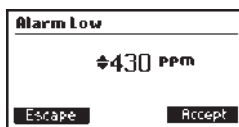
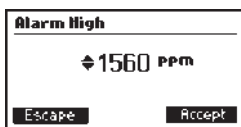
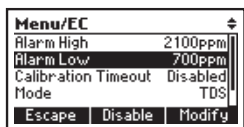

## Calibration Timeout

**Calibration Timeout** feature is used to set a scheduled reminder for calibration or service. It can be configured 1-30 days or disabled (no message). A reminder message will be displayed with the measurement indicating it's time to service the probe.

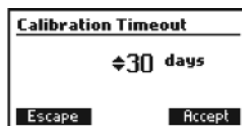
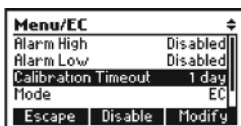
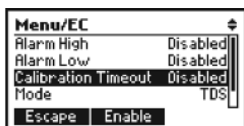

## Mode

Press functional key to change EC with TDS mode.

Press **Escape** to return to the general menu.

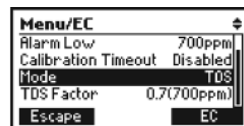

## TDS Factor

Press functional key to choose desired TDS factor: 0.5 (500ppm) or 0.7 (700ppm). Press **Escape** to return to the general menu.

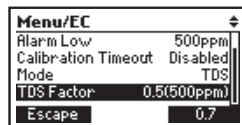

### 5.6.5. TEMPERATURE SETUP

**Alarm High** and **Alarm Low** in the Temperature menu have two options, **Enable** or **Disable**.

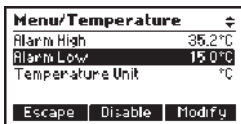
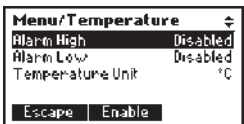

When alarms are set to **Enable**, press **Modify** to adjust the temperature alarm value.

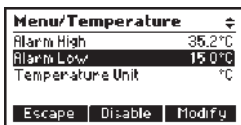
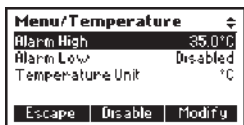

Use ▲▼ keys to set temperature alarm value.

*Note: The high alarm must be set to a value greater than the low alarm value.*

Press the **Accept** key to confirm the value or **Escape** to return to the general menu without saving the new value.

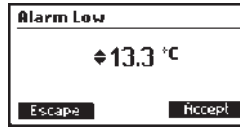
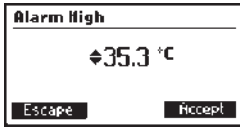

When selected temperature unit is °F, alarm values will be displayed in same unit.

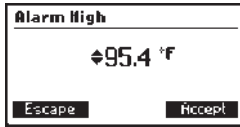
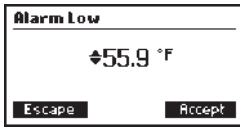

### Temperature Unit

**Option:** °C or °F

Press the functional key to select the desired temperature unit, Celsius or Fahrenheit.

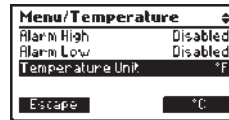

Press **Escape** to return to the general menu.

### 5.6.6. ALARMS

The alarm feature provides visual indication that a parameter has diverged from the preferred measurement readings.

Active alarms: when an alarm is activated, the display will flash providing a visual indication from a distance that an alarm set-point has been triggered. The flashing will stop after the measurement has returned to the configured limits. In addition to the LCD flashing, the message bar will display alarm information and the affected parameter will also blink; pH, EC (TDS) or temperature.

**Table 1** below tabulates the configurable alarm parameters and the factory set defaults.

Parameter	Setup options	Default
pH	Enable Disable	Disable
	Alarm High	7.50 pH
	Alarm Low	5.50 pH
EC/TDS	Enable Disable	Disable
	Alarm High	3.00 mS/cm (2100 ppm for 0.7 CF)
	Alarm Low	1.00 mS/cm (700 ppm for 0.7 CF)
Temperature	Enable Disable	Disable
	Alarm High	35 °C (95 °F)
	Alarm Low	15 °C (59 °F)

**Table 1.** Configurable alarm parameters

## 6. OPERATIONAL GUIDE

### 6.1. PROBE CALIBRATION

The probe should be calibrated:

- before being installed in the system.
- after probe replacement.
- daily, if greater accuracy is required.
- every 2 weeks as part of routine maintenance (HI1285-8 only).

Every time you calibrate the Monitor use fresh buffer standards and perform electrode maintenance as required. It is advised to choose calibration buffers that bracket the sample pH.

Two calibration modes are available for pH and EC:

- Quick calibration: easily accessible from Menu, allows simultaneous single-point calibrations for pH and EC using quick calibration solution.
- Standard calibration: accessible from pH or EC Menu; allows pH calibration with one or two buffers (from 3 eligible pH values: 4.01; 7.01; 10.01) and a single EC calibration point (with standards 1.41 mS/cm or 5.00 mS/cm).

#### Preparation

Pour small quantities of buffer solutions into clean beakers. If possible, use plastic beakers to minimize any EMC interferences. For accurate calibration and to minimize cross-contamination, use two beakers for each buffer solution: one for rinsing the probe and one for calibration.

#### 6.1.1 QUICK CALIBRATION

For quick calibration use HI5036 quick calibration solution (HI50036 sachet or HI5036-050 500 mL bottle).

Submerge the probe a minimum of 4 cm (1½") into the solution and stir gently.

Select **Quick Calibration** from MENU.

Press **Start** and Monitor enters in **Quick calibration** screen.

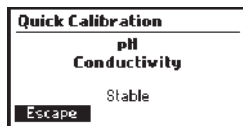

When the standard value is recognized and stability is reached the Monitor automatically accepts the calibration.

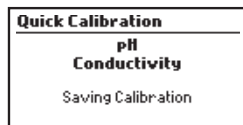



After saving the calibration the Monitor returns to MENU.  
Pressing **Escape** can exit the quick calibration without saving data.

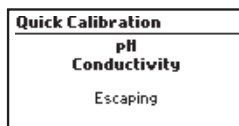

If the standard is not recognized or the offset is out of accepted range, "Wrong Standard" is displayed. Refresh the calibration solution, clean and rinse the probe or press **Escape** to exit calibration.

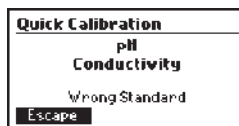

### 6.1.2. pH CALIBRATION

If you are measuring in the acidic range, use pH 7.01 as the first buffer and pH 4.01 as the second buffer. If you are measuring in the alkaline range, use pH 7.01 as the first buffer and pH 10.01 as the second buffer.

Select **pH** from MENU and press **CAL** to enter pH calibration function.

While in pH Calibration mode, the display will show current pH reading, current temperature reading and current buffer:

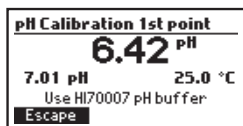

The following functions are available in pH Calibration mode:

- **Clear:** Press to clear the last calibration from the Monitor. After confirming, the "Calibration cleared" message is displayed.

*Note: The GLP history will show "Calibration cleared" message with the date.*

- **Confirm:** Press to accept the current calibration point which is only available if the measurement is stable and within the limits for the selected buffer.
- **Escape:** Press to exit calibration and return to MENU.

### Procedure

Calibration can be performed using one or two calibration buffers. For higher accuracy, a two-point calibration is recommended.

Submerge the probe a minimum of 4 cm (1½") into a buffer solution and stir gently.

## Two-point calibration

From the MENU screen with pH highlighted, press the **CAL** key to begin the calibration process.

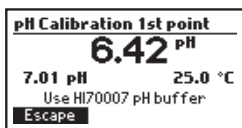

The monitor will suggest using the **HI70007** pH 7.01 buffer, but it will automatically recognize **HI70004** pH 4.01 and **HI70010** pH 10.01 buffers.

*Note: For two-point calibration, the buffer 7.01 pH must be used for the first point.*

When the reading is stable and close to the selected buffer, the **Confirm** key will become available. Press **Confirm** to accept and store the calibration point. The monitor will now prompt for the second buffer .

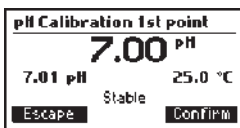

To continue calibrating with a second buffer, rinse and submerge the pH electrode 4 cm (1½”) into the second buffer solution and stir gently.

The **Monitor** will automatically recognize second buffer 4.01 or 10.01 pH.

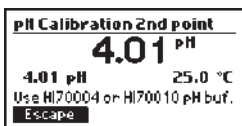

If **Escape** is pressed during the second buffer the display will return in **MENU**. Only the first calibration point will be saved.

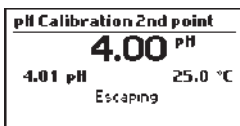

When the reading is stable and close to the selected buffer, the **Confirm** key will become available. Press **Confirm** to accept and store the calibration point 4.01 or 10.01 pH.

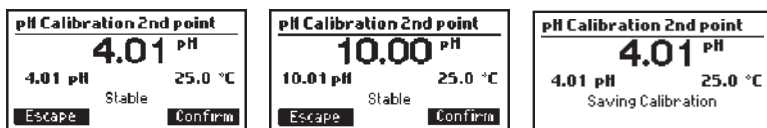

The **Monitor** stores the two-point calibration information and returns to MENU mode.

### One-point calibration

To perform a one-point calibration only, press **Escape** to calibrate in 7.01 pH, or, the **Monitor** will automatically save one calibration point for 4.01 and 10.01 pH. It will store the calibration information and return to MENU.

#### 6.1.3. EC CALIBRATION

Select EC from MENU and press **CAL** to enter the EC calibration function.

The following functions are available in EC Calibration mode:

- **Clear:** Press to clear the last calibration from the **Monitor**. After confirming, the “Calibration cleared” message is displayed.
- **Confirm:** Press to accept the current calibration point which is only available if the measurement is stable and within the limits for the selected EC standard solution.
- **Escape:** Press to exit calibration and return to MENU.

While in **EC Calibration** mode, the display will show the current EC reading, the current temperature reading and the current standard:



The calibration can be erased at any time by entering the calibration and pressing **Clear**. A warning message appears and confirmation for deleting the calibration is requested. Press **Accept** to confirm or **Cancel** to exit and return to calibration screen.

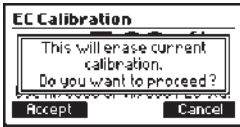

*Note: The GLP history will show "Calibration cleared" message with the date.*

Immerse the probe in 1.41 mS/cm or 5.00 mS/cm calibration solution.

From the MENU screen with EC highlighted, press the **CAL** key to begin the calibration process. EC standard value will be autorecognized by the **Monitor**.

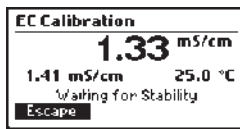

When the reading is stable and close to the selected standard, the **Confirm** key will become available. Press **Confirm** to accept and store the calibration point.

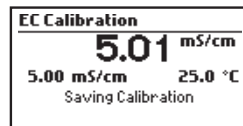
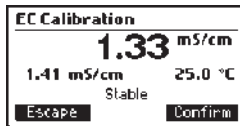
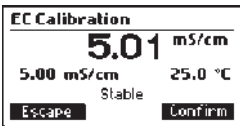

Press **Escape** to exit calibration without saving the calibration.

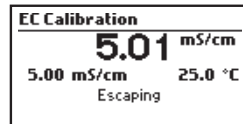

## Calibration messages

### Wrong Buffer

If the buffer is not recognized or the offset is out of the accepted range, "Wrong Buffer" message is displayed.

Change the buffer, clean the electrode and repeat calibration.

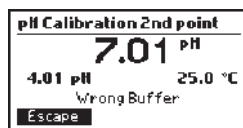

### Wrong Standard

If the EC standard is not recognized "Wrong Standard" message is displayed. Change the solution, clean the electrode and repeat calibration.



### Wrong Temperature

If the temperature sensor is reading an extreme value, the "Wrong Temperature" message is displayed. Replace probe.

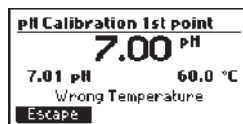

### No buffer detected

This message appears if the probe has detected no buffer.



### Invalid slope

This message appears when the calculated slope is not in the acceptable range.



### Clean electrode

This indicates poor pH electrode performance (offset out of accepted window, or slope under the accepted lower limit).

Cleaning the probe will improve the pH electrode's response.

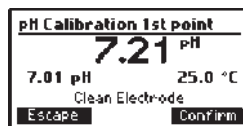

## 6.2. GLP INFORMATION

Good Laboratory Practice (GLP) refers to a quality control function used to ensure uniformity and consistency of sensor calibrations and measurements. Select **pH** or **EC** from MENU and press **GLP** to review the calibration information. The **Monitor** can store calibration info from the last five pH and EC calibrations. The newest calibration is positioned at #1. Pressing **▲ ▼** keys in GLP can view the informations from last five calibrations.

### GLP pH

Highlight **pH** from MENU and press **GLP**. Monitor will display date/time, buffer used, slope and offset from last five calibrations.

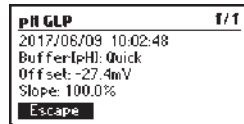
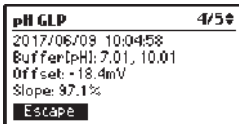
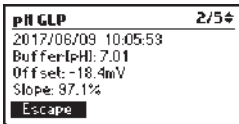

If a single-point buffer calibration was made, the previous calibration slope will be used.  
If all calibrations have been cleared “No user calibration” message is displayed.

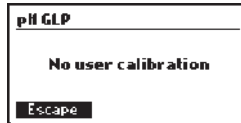

### GLP EC

Highlight **EC** from MENU and press **GLP**. The monitor will display date/time, standard and cell coefficient from the last five calibrations. The cell coefficient can be used to determine when the probe requires cleaning. If this number decreases below 75% the probe requires cleaning.

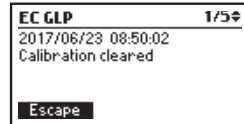
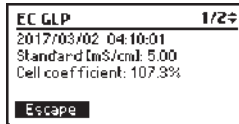

If all calibrations have been cleared “No user calibration” message is displayed.

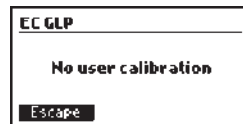

### 6.3. MEASUREMENT MODE



Turn ON the **Monitor** by connecting the power adapter to the power cable socket. After initialization has been completed, the controller displays the measurement screen.

- Ensure the probe is installed and calibrated.
- Install the probe in the tank and ensure that the bottom 4 cm are submersed in the sample solution.
- Upon powering the **Monitor**, the measurement screen displays all measured parameters. By using ▲▼ arrows the user can access the three display options detailed below:

#### All parameters screen

This screen is the default screen and displays all measured parameters.

This screen will be displayed each time the **Monitor** is started.

Depending on setup, the **Monitor** will display EC/TDS and temperature in °C or °F.

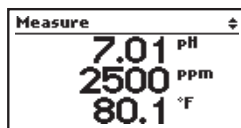
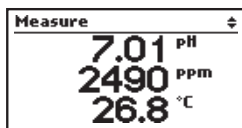
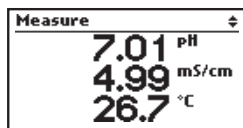

#### Single parameter screen

This screen permits better visualization from a distance.

Temperature, pH and EC/TDS parameters are automatically switched between every three seconds.

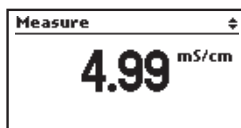
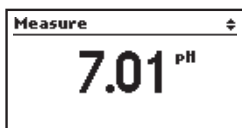
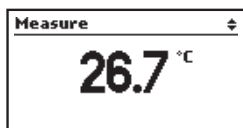

#### Real time plot screen

This screen is a plot representation of the last measurement of the selected parameters.

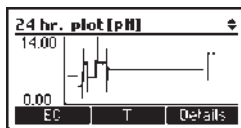

The first two functional buttons select the parameter, whereas the title bar indicates currently selected parameter unit.

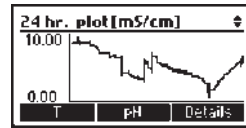
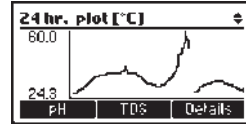

Press **Details** to access information regarding selected parameters: current reading, Max / Min reading and average.

24 hr. summary [mS/cm]		
Current:	4.99 mS/cm	
Max:	10.00 mS/cm	11:52AM
Min:	3.11 mS/cm	12:07PM
Average:	5.79 mS/cm	
T	pH	Plot

24 hr. summary (pH)		
Current:	7.01 pH	
Max:	7.04 pH	01:22PM
Min:	0.00 pH	12:07PM
Average:	6.88 pH	
EC	T	Plot

24 hr. summary [°C]		
Current:	26.7 °C	
Max:	60.0 °C	12:07PM
Min:	20.4 °C	07:34AM
Average:	21.8 °C	
pH	EC	Plot

### Status bar messages

Whenever an event is triggered, the status bar will display it on measure screen.

Possible events:

- "Logging disabled" - when date and time aren't set or the real time clock is malfunctioning. The backlight will blink to signal this malfunction.

Logging disabled
4.23 pH
5.00 mS/cm
25.0 °C

- "pH / EC/TDS / Temp. Out of Range" - measurements have exceeded the Monitor's specifications. The backlight and the affected parameter will blink.

pH Out of Range
14.00 pH
4.62 mS/cm
25.0 °C

EC Out of Range
3.54 pH
10.00 mS/cm
25.0 °C

Temp. Out of Range
3.08 pH
9.17 mS/cm
0.0 °C

*Note: For some parameters, alarms and other warnings are not visible while "Out of range" message persists. This message has a higher priority than alarms and warnings.*



- "Alarm High/Low pH / EC/TDS / Temp." - measurements have exceeded the specified High or Low limits. The backlight and the affected parameter will blink.

<b>Alarm Low pH</b> ⚙
<b>4.23</b> pH
<b>5.00</b> mS/cm
<b>25.0</b> °C

<b>Alarm High EC</b> ⚙
<b>7.57</b> pH
<b>5.00</b> mS/cm
<b>25.0</b> °C

<b>Alarm Low Temp.</b> ⚙
<b>7.59</b> pH
<b>0.00</b> mS/cm
<b>14.0</b> °C

*Note: For some parameters, warnings will not be visible while "Alarm High/Low" message persists. This has higher priority than warnings.*

- "pH / EC/TDS Clean/Cal. Due" - last calibration exceeded the specified time interval or there is no calibration.

<b>EC Clean/Cal. Due</b> ⚙
<b>7.08</b> pH
<b>4.62</b> mS/cm
<b>25.0</b> °C

<b>pH Clean/Cal. Due</b> ⚙
<b>7.08</b> pH
<b>4.62</b> mS/cm
<b>25.0</b> °C

*Note: There are two ways to clear this message: perform a calibration or disable it from parameter setup.*

## 7. DATA STORAGE

The GroLine Monitor logging system automatically saves measurement data. Stored data can be accessed two ways: either from the measurement screen or from the History menu.

Data from the last 24 hours can be accessed directly from the measurement screen.

The screen will display a 24 hours summary that includes:

- the current value for the selected parameter.
- Min/Max and average values measured over an interval of 15 minutes.
- a plot of the selected data.

### 7.1. 24 HR. DATA FROM MEASUREMENT SCREEN

To access the logged data press the ▲ ▼ keys on measurement screen. Press **Details** key to access 24hr. summary and **parameters** key to select information for desired parameter:

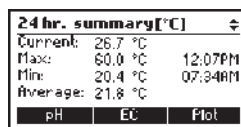
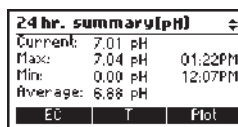
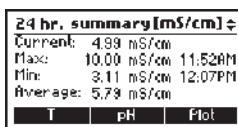

Press **Plot** to display the data graphically.

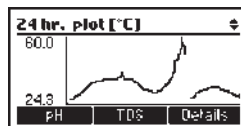
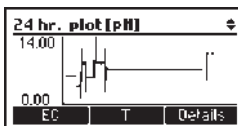
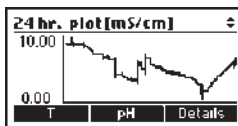

### 7.2. HISTORY

Several data plots can be viewed from History menu.

The following presentations are possible:

- 30 days plots for pH, EC and temperature using average values
- single day plots (for the last 24 hours) of pH, EC and temperature
- Min/Max and average values tabulated in 15 minutes interval for up to 30 days of data

*Note: Data is overwritten after 30 days so it should be backed up if needed.*

When date and time aren't set or the real time clock is malfunctioning, "Logging disabled" appears on measure screen (in the status bar) and the backlight starts to blink.

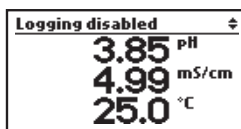

To access, press MENU, highlight **History** and press **View**. The Monitor will display a 30 days data plot. Change the parameter by pressing the second function key.

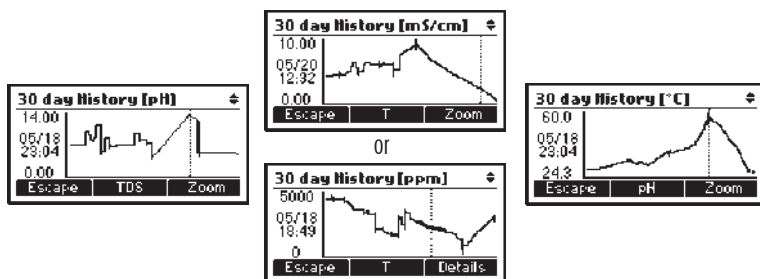

Press the ▲ ▼ keys to select desired day, then press **Zoom** to view the one day plot.

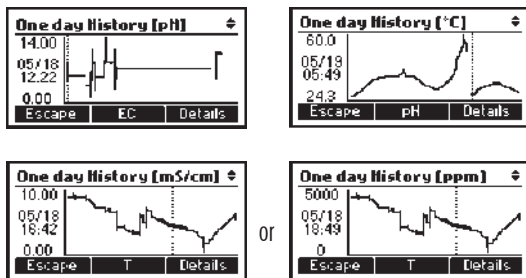

Press **Details** to view the tabulated data with date and time stamp.

Press the ▲ ▼ keys, to scroll through the daily records, Max/Min and average readings.

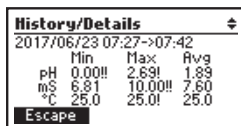

Press **Escape** to return to plot mode.

Press **Escape** a second time to return to Menu.

Note: If “!” appears in logged data (\*.csv and History/Details screen), an alarm is triggered. The symbol for High/Low alarm is added next to Max/Min column of the affected parameter.

Note: If “!!” appears in logged data (\*.csv and History/Details screen), the probe is used beyond monitor’s specifications and the data is not considered reliable.

### 7.3. DATA EXPORT

There are three options. Two are used to export data and the third is used to clear the log and start a new log session.

Highlight **History** from Menu using ▲ ▼ and press **Options** to access History/Export options.

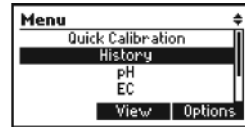

Note: Data will be exported in the EC/TDS format the monitor is configured at the time of export. This includes temperature unit, TDS factor and mode.



#### Exporting to flash drive

Connect USB C to the monitor.

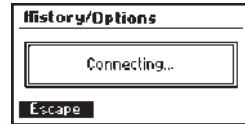

Highlight **Export to flash drive** using ▲ ▼, then press **Select**. The file transfer will begin after connection has been established.

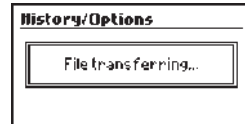

If the flash drive contains a previously saved file, it will query about overwriting the file. If the monitor has an ID, the file name will reflect that identification and a letter. Exporting a second file from the same monitor will increment the letter by one (e.g. if the ID is 123, the file names will be GLM0123 A through GLM0123 Z. If all letters are taken, an overwrite message appears.

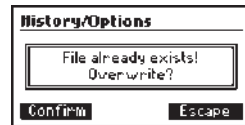

After the file transfer has ended, the monitor displays "File transfer completed" message. Press **Done** to return to Export screen.

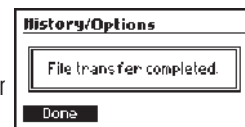

If the USB flash drive is missing or not detected, the monitor displays a warning message: "No flash drive connected".

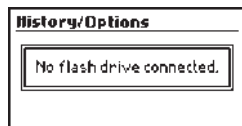

### Exporting to PC

Highlight **History** from MENU and press **Options** function. Connect an USB cable between the PC and monitor. Highlight **Export to PC** using ▲ ▼, then press **Select**.

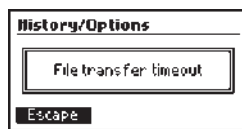

After connection has been established the file is displayed on the **Monitor**. Open the file and save to PC in desired format, name and location.

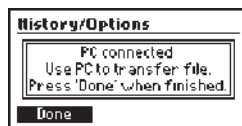

If the USB cable is missing or not detected the **Monitor** displays "Check the USB cable" message.

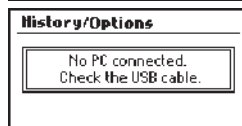

The transferred data is saved to the USB flash drive in a file named as "GLMxxxx.csv", where "xxxx" represents the unit's ID and "y" represents a letter from A to Z. This file naming format helps to avoid overwriting the same file. In case of all letters being used, the overwrite warning appears and the "GLMxxxxA.csv" will be replaced. (For an example see Exporting to flash drive section).

Logged data are formatted as configured in the Decimal separator parameter (\*.csv) and can be opened with any text editor or spreadsheet program.

Suggested settings for correct formatting: use period field separator for Western Europe character set (ISO-8859-1). Adjust font or column width appropriately.



### Clearing history

Highlight **History** from MENU and press **Options**. Highlight **Clear history** using ▲ ▼, then press **Select** to permanently delete logged history. Press **Accept** to initiate procedure or **Cancel** to return to History options without clearing.

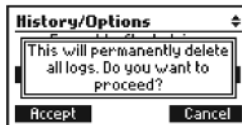

## 8. ACCESSORIES

HI1285-8	pH/EC/TDS probe with built-in temperature sensor, DIN connector and 2 m (6.6') cable
HI1285-9	Triple junction inline pH/EC/TDS probe with built-in temperature sensor, 3/4" NPT threaded body, DIN connector and 3 m (9.8") cable
HI740036P	Plastic beaker set, 100 mL (10 pcs.)
HI60501	Immersion electrode holder from PVC
HI605011	Mounting flange for immersion electrode holder

## ELECTRODE STORAGE SOLUTIONS

HI70300-050	Storage solution, 500 mL
HI70300G	Storage solution, 20 mL sachets (25 pcs.)

## ELECTRODE CLEANING SOLUTIONS

HI7061-050	General purpose cleaning solution, 500 mL
HI70061G	General purpose cleaning solution, 20 mL sachets (25 pcs.)

## BUFFER SOLUTIONS

HI70004G	pH 4.01 Buffer solution, 20 mL sachets (25 pcs.)
HI70007G	pH 7.01 Buffer solution, 20 mL sachets (25 pcs.)
HI70010G	pH 10.01 Buffer solution, 20 mL sachets (25 pcs.)
HI50036P	Quick calibration solution, 20 mL sachets (25 pcs.)
HI7004-050	pH 4.01 Buffer solution, 500 mL
HI7007-050	pH 7.01 Buffer solution, 500 mL
HI7010-050	pH 10.01 Buffer solution, 500 mL
HI5036-050	Quick calibration solution, 500 mL

## EC SOLUTIONS

HI70031G	1413 $\mu\text{S}/\text{cm}$ (1.41 mS/cm) solution, 20 mL sachets (25 pcs.)
HI70039G	5000 $\mu\text{S}/\text{cm}$ (5.00 mS/cm) solution, 20 mL sachets (25 pcs.)
HI50036P	Quick calibration solution, 20 mL sachets (25 pcs.)
HI7031-050	1413 $\mu\text{S}/\text{cm}$ (1.41 mS/cm) solution, 500 mL
HI7039-050	5000 $\mu\text{S}/\text{cm}$ (5.00 mS/cm) solution, 500 mL
HI5036-050	Quick calibration solution, 500 mL

## Certification

All Hanna instruments conform to the CE European Directives.



RoHS  
compliant

**Disposal of Electrical & Electronic Equipment.** The product should not be treated as household waste. Instead hand it over to the appropriate collection point for the recycling of electrical and electronic equipment which will conserve natural resources.

**Disposal of waste batteries.** This product contains batteries, do not dispose of them with other household waste. Hand them over to the appropriate collection point for recycling.

Ensuring proper product and battery disposal prevents potential negative consequences for the environment and human health. For more information, contact your city, your local household waste disposal service, the place of purchase or go to [www.hannainst.com](http://www.hannainst.com).



## Recommendations for users

Before using these products make sure that they are entirely suitable for your specific application and for the environment in which they are used.

Operation of these instruments may cause unacceptable interferences to other electronic equipment. Take all necessary steps to correct such interferences. Any variation introduced by the user to the supplied equipment may degrade the instruments EMC performance.

To avoid damages or burns, do not put the instrument in a microwave oven. For yours and the instrument's safety do not use or store the instrument in hazardous environments.

## Warranty

The **HI981420** is warranted for two years against defects in workmanship and materials when used for their intended purpose and maintained according to instructions. The probe is warranted for a period of 6 months. Damage due to accidents, misuse, tampering or lack of prescribed maintenance is not covered.

If service is required, contact your local Hanna Instruments Office. If under warranty, report the model number, date of purchase, serial number and the nature of the problem. If the repair is not covered by the warranty, you will be notified of the charges incurred. If the instrument is to be returned to Hanna Instruments, first obtain a Returned Goods Authorization (RGA) number from the Technical Service department and then send it with shipping costs prepaid. When shipping any instrument, make sure it is properly packed for complete protection.

Hanna Instruments reserves the right to modify the design, construction or appearance of its products without advance notice.



## World Headquarters

Hanna Instruments Inc.  
Highland Industrial Park  
584 Park East Drive  
Woonsocket, RI 02895 USA  
[www.hannainst.com](http://www.hannainst.com)

MAN981420

Printed in ROMANIA