

IKA

designed for scientists

IKA ICC control



Operating instructions

EN

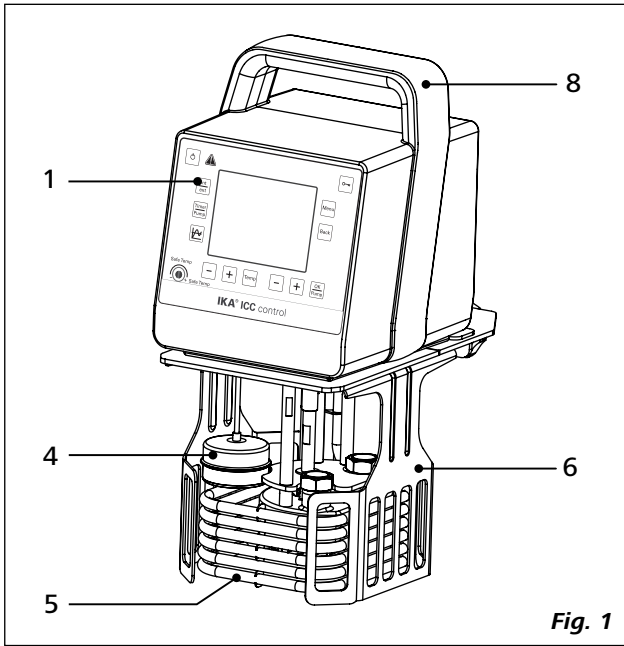

Fig. 1

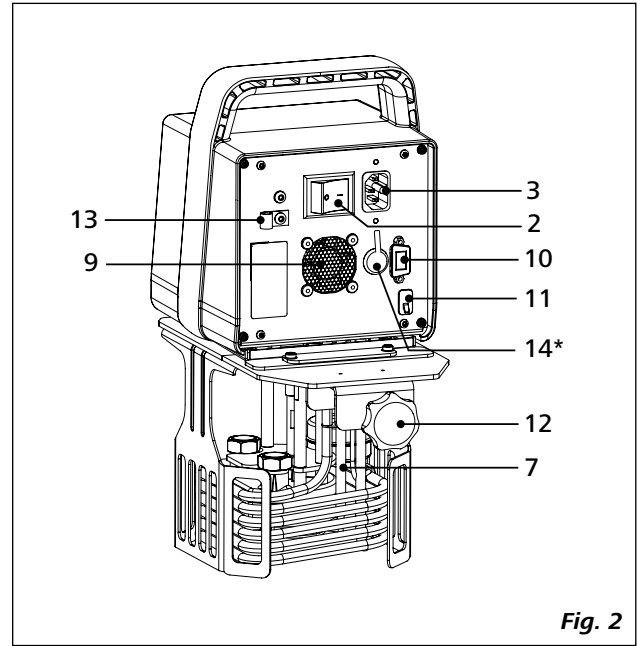

Fig. 2

Item	Designation
1	Operator panel and display
2	Mains switch
3	Power socket
4	Buoyage
5	Heater
6	Stand
7	Pt 100 + Pt 1000 temperature sensor
8	Handle
9	Fan
10	RS 232 port
11	USB port
12	Clamp
13	Cable clip
14	External temperature sensor socket

Contents

	Page
EU Declaration of Conformity	4
Explication of warning symbols	4
Safety instructions	5
General information	5
Fluids.....	6
Intended use	7
Use	7
Range of use	7
Unpacking	7
Unpacking.....	7
Delivery scope	7
Useful information	7
Preparations	7
Setting up	7
Filling and draining	7
Fluid (Standard information for IKA fluid)	8
Operator panel and display	9
Commissioning	10
Setting the safety temperature	11
Operation	11
Working screen at the time of delivery.....	11
Explanation of symbols on the working screen.....	11
Menu navigation and structure	12
Menu (Details)	14
Interface and output	16
Maintenance and cleaning	18
Error codes	19
Accessories	20
Technical data	21
Warranty	22
Pump performance curve	22

EU Declaration of Conformity

We declare under our sole responsibility that this product corresponds to the directives 2014/35/EU, 2006/42/EC, 2014/30/EU and 2011/65/EU and conforms with the following standards or normative documents: EN 61010-1, EN 61010-2-010, EN 61326-1, EN 60529, DIN 12876-1 und EN ISO 12100.

A copy of the complete EU Declaration of conformity can be requested at sales@ika.com.

Explication of warning symbols



Indicates an imminently hazardous situation, which, if not avoided, will result in death, serious injury.



Indicates a potentially hazardous situation, which, if not avoided, can result in death, serious injury.



Indicates a potentially hazardous situation, which, if not avoided, can result in injury.



Indicates practices which, if not avoided, can result in equipment damage.



Reference to exposure to a hot surface!



Hot surface!

Safety instructions

General information:

- **Read the operating instructions completely before starting up and follow the safety instructions.**
- Keep the operating instructions in a place where it can be accessed by everyone.
- Ensure that only trained staff work with the device.
- Follow the safety instructions, guidelines, occupational health, safety and accident prevention regulations.
- Set up the device in a spacious area on an even, stable, clean, non-slip, dry and fireproof surface.
- Do not operate the device in explosive atmospheres, with hazardous substances.
- Protect the device and accessories from bumping and impacting.
- Check the device and accessories for damage before each use. Do not use damaged components.
- Safe operation is only guaranteed with the accessories described in the "**Accessories**" section.
- The device must only be operated with the original mains cord.
- The socket for the mains cord must be easily accessible.
- Socket must be earthed (protective ground contact).
- The voltage stated on the type plate must correspond to the mains voltage.
- The device can only be disconnected from the mains supply by pulling out the mains plug or the connector plug.
- Disconnect the mains plug before attaching or changing any accessories.
- Disconnect the mains plug before cleaning, maintenance and transportation of the unit.
- The device must only be opened by trained specialists, even during repair. The device must be unplugged from the power supply before opening. Live parts inside the device may still be live for some time after unplugging from the power supply.

NOTICE

Coverings or parts that can be removed from the device without the aid of any tools must be put back on the device again to ensure safe operation, for example to keep foreign objects and liquids, etc. from getting into the device.

- The device may only be used as prescribed and as described in the operating instructions. This includes operation by instructed specialist personnel.
- When using critical or hazardous materials in your processes, **IKA** recommends to use additional appropriate measures to ensure safety in the experiment. For example, users can implement measures that inhibit fire or explosions or comprehensive monitoring equipment.
- Process pathogenic material only in closed vessels under a suitable fume hood. Please contact **IKA** application support if you have any question.

WARNING

If the power switch is not within reach when device is operating, an **EMERGENCY STOP** switch that can be easily accessed must be installed in the work area.

- A laboratory circulator heats and circulates fluid according to specified parameters. This involves hazards due to high temperatures, fire and general hazards due to the device of electrical energy. The user safety can not be ensured simply with design requirements on the part of the device. Further hazard sources may arise due to the type of tempering fluid, e.g. by exceeding or undercutting certain temperature thresholds or by the breakage of the container and reaction with the heat carrier fluid. It is not possible to consider all eventualities. They remain largely subject to the judgment and responsibility of the operator. For this reason, it may become necessary for user to take other precautionary safety measures.
- Insufficient ventilation may result in the formation of explosive mixtures. Only use the device in well ventilated areas.

WARNING

The safety circuit (safe temperature) must be adjusted so that the maximum permissible temperature cannot be exceeded even in the event of a fault. Check the safe temperature circuit on a regular basis (see section "**Setting the safety temperature**").

- Securely fix the **ICC** immersion circulator for use at the bath, so that it cannot tip over.
- When device is used for external circulation, extra precaution must be taken for hot fluid leakage due to damaged hose.
- Use suitable hoses for connection.
- Secure hoses and tubes against slippage and avoid kinks.
- Check hoses, tubes and bath at regular intervals for possible material fatigue (cracks/leaks).
- Mains cable should not get in contact with hot parts and fluids.
- If you are using plastic bath, observe the permitted working temperature range and fluids.

DANGER

Do not start up the device if:

- It is damaged or leaking
- Cable (not only supply cable) is damaged.
- Be careful when filling a hot bath.

WARNING

At high operating temperatures, the temperature of housing parts, surfaces and tubes can exceed 70 ° C.



WARNING

It is dangerous to touch the heater. The temperature of the heater can be very high.

- After a power failure during operation, the device may start automatically (depending on operating mode).
- Transport the device with care.
- Do not transport or empty the bath while it is still hot. This may result in accidents, especially scalding injuries.



NOTICE

In order to prevent the power cable from falling into the fluid, the mains cable must be secured with the cable clamp (13, see Fig. 2).

Fluids:



WARNING

Beware of the risk of burning due to delay in boiling!

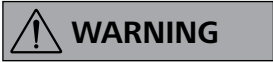

WARNING

Only use fluids, which fulfill the requirements for safety, health and device compatibility. Be aware of the chemical hazards that may be associated with the bath fluid used. Observe all safety warnings for the fluids.

- Depending on the bath fluid used and the type of operation, toxic or flammable vapors can arise. Ensure suitable extraction.
- Do not use any fluid which may cause dangerous reactions during processing.
- Only use recommended bath fluid. Only use non-acid and non corroding fluid.



WARNING

Only process and heat up any fluid that has a flash point higher than the adjusted safe temperature limit that has been set. The safe temperature limit must always be set to at least 25 °C lower than the flash point of the fluid used. Examine regularly the function of the safety temperature limiter.



NOTICE

Never operate the device without sufficient heat carrier fluid! You should also be careful to ensure that the minimum clearances and immersion depths in the fluid are observed. Check the fluid level detection at a regular basis (see section "Filling and draining").



NOTICE

If water is used at higher temperature, there is heavy loss of fluid due to the evaporation.

- Untreated tap water is not recommended. It is recommended to use distilled water or high purity water (ion exchangers) and add 0.1 g soda (sodium carbonate Na₂CO₃) /liter, to reduce corrosive properties.



WARNING

Risk of burning caused by vapor or hot water at the outlet of the cooling coil (accessory).



NOTICE

Do not use the cooling coil with water at bath temperatures > 95° C.



NOTICE

For bath temperatures > 60°C make sure that the flow rate through the cooling coil is high enough.



NOTICE

Don't use following fluids:

- Untreated tap water
- Acids or bases
- Solutions with halides: chlorides, fluorides, bromides, iodides or sulfur
- Bleach (Sodium Hypochlorite)
- Solution with chromates or chromium salts
- Glycerine
- Ferrous water.



NOTICE

When changing the bath fluid from water to a heat transfer fluid for temperatures above 100 °C, remove the remaining water from the complete system (including hoses and external devices). When doing this, also open the stopper and union nuts caps of the pump outputs and inputs and blow compressed air through all the pump outputs and inputs!

Correct use

Use:

Use **ICC (Immersion Circulator Compact) control** for heating and circulating fluids.

Intended Use: Tabletop Device

Range of use:

Indoor environments similar to that a laboratory of research, teaching, trade or industry.

The safety of the user cannot be guaranteed:

- If the device is operated with accessories that are not supplied or recommended by the **IKA**
- If the device is operated improperly or in contrary to the **IKA** specifications.
- If the device or the printed circuit board are modified by third parties.

Unpacking

Unpacking:

- Please unpack the device carefully
- In the case of any damage a detailed report must be sent immediately (post, rail or forwarder).



NOTICE

Transport safety:

Remove the transport protection under the buoyage (4).

Delivery scope:

- **ICC control**
- Mains cables
- USB 2.0 cable (A – micro B)
- Screwdriver (use for safety circuit)
- User guide
- A warranty card.

Useful information

When you operate the device in water bath with temperature higher than 60°C do not switch off the device before the temperature is below 60°C. Water steam could enter into the housing and cause damage.

Starting from software version 1.3.001 a function is included which will let run the internal fan to avoid this effect even if the device is switched to standby mode (by pressing the On/Off button **(A)**).

Do not disconnect the power cord or switch the device off by pressing the power switch **(2)**. Alternatively remove the ICC device out of the bath.

Update the firmware to enable this feature (see section "Interface and output").

Note: with an older software version let the pump run until the water temperature is below 60°C.

Preparations

Setting up:

- Securely fix the immersion circulator on the bath.
- Place the device on an even, stable, clean, non-slip, dry and fireproof surface.
- Keep at least 20 cm of open space at the front and rear side.
- When a plastic bath is used, please ensure that the heater does not contact the bath.
- The place for installation should be large enough and provide sufficient air ventilation to ensure the room does not warm up excessively because of the heat from device radiates to the environment.
- Do not set up the device in the immediate vicinity of heat sources and do not expose to sun light.

Filling and draining:

- Connect the mains plug and turn on the device with mains switch **(2)**.
- The low level icon () appears on the display.
- Fill fluid to the bath.

Note: Pay attention to the fluid level information on the display:

 — *Low level*

 — *High level*

For draining, please refer to the bath operating instructions.

• **Fluid (Standard information for IKA fluid):**

IKA Designation	Operating temperature range for open bath application (°C)	Operating temperature range for closed bath applications (°C)	Safety temperature (°C)	Flash point (°C)
CF.EG28.N10.80.8	-10 ... 80	-10 ... 80	90	115
CF.EG39.N20.80.16	-20 ... 80	-20 ... 80	90	115
CF.EG44.N25.80.19	-25 ... 80	-25 ... 80	90	115
CF.EG48.N30.80.22	-30 ... 80	-30 ... 80	90	115
UF.Si.N30.150.10LV	-30 ... 130	-30 ... 150	145 ❶	>170
HF.Si.20.200.50	20 ... 200	20 ... 200	255	>280
HF.Si.20.250.50A	20 ... 200	20 ... 250	255	>280
H ₂ O (Water) ❷	5 ... 95	5 ... 95	-	-
Customized 1 ❸				
Customized 2 ❸				

Check the suitability of the fluid according to your application.

Nomenclature for **IKA** fluid:

CF.EG28.N10.80.8 --

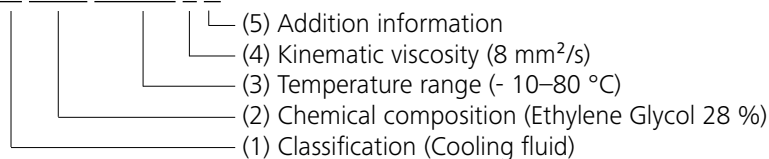

(1) Classification:

HF: Heating Fluid
 CF: Cooling Fluid
 UF: Universal Fluid

(2) Chemical composition:

Si: Silicone oil
 EG: Ethylene Glycol

(3) Temperature range: (Minimum temperature. Maximum temperature)

N: Negative Temperature

(4) Viscosity:

Viscosity at 25 °C for Heating Fluid (HF)
 Viscosity at -20 °C for Cooling Fluid (CF)
 Viscosity at 25 °C for Universal Fluid (UF)

Dynamic viscosity [mPa•s] is a product of kinematic viscosity [mm²/s] and density [kg/m³] of the fluid divided by 1000.

(5) Additional information:

A: Oil Additives
 LV: Low Viscosity

❶ Note: for open bath application!

❷ Note: Tap water may be unsuitable for operation because the calcium carbonate content may cause calcification. High purity water (from ion exchangers) and distilled or bi-distilled water are unsuitable for operation due to corrosive properties of these media. High purity water and distillates are suitable as a medium after adding 0.1 g soda (Na₂CO₃, sodium carbonate) per liter of water.

❸ Note: The limits can be adjusted according to the fluid used.

Operator panel and display

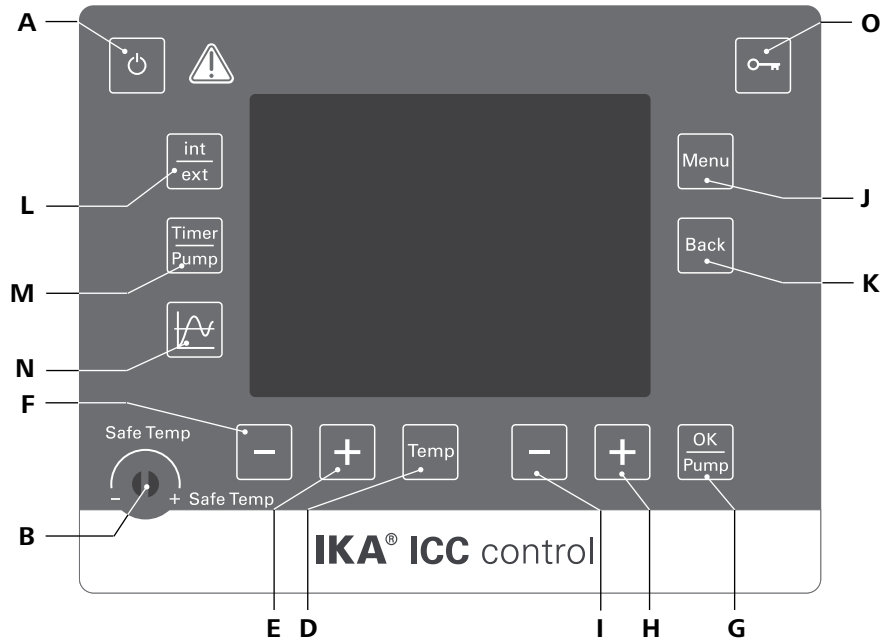
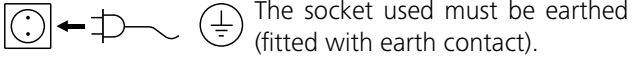

Fig. 3

Item	Designation	Function
A	ON/OFF button:	Switch on/off the circulator.
B	Adjustable safety circuit:	Adjust the safety temperature limit with delivered screwdriver.
D	"Temp" button:	Start/stop the heating function.
E	"Temp (+)" button:	Increase the temperature setting value.
F	"Temp (-)" button:	Decrease the temperature setting value.
G	"OK/Pump" button:	Start/stop the pump function. Select and open the menu options.
H	"Pump (+)" button:	Increase the pump speed setting value.
I	"Pump (-)" button:	Decrease the pump speed setting value.
J	"Menu" button:	Navigation and changing the setting in the menu. Press it once: menu option is display.
K	"Back" button:	Press it a second time: back to the working screen. Return to the previous menu level.
L	"int/ext" button:	Switch between the internal and external temperature display and control.
M	"Timer/Pump" button:	Switch between the timer and pump display.
N	Graph button:	Display time/temperature graph
O	Key button:	Lock/unlock keys.

Commissioning

Check whether the voltage given on the type plate corresponds to the available mains voltage.



The socket used must be earthed (fitted with earth contact).

If these conditions have been met, the machine is ready for operation when the mains plug is plugged in.

If these conditions are not met, safe operation is not guaranteed and the machine could be damaged.

Observe the ambient conditions (temperature, humidity, etc.) listed under “**Technical Data**”.

After switch on the mains switch (2) at the back of the device or pressing the power key (A), the screen displays the device designation and the software version after a beep.



Fig. 4

After several seconds, screen display the information of device.

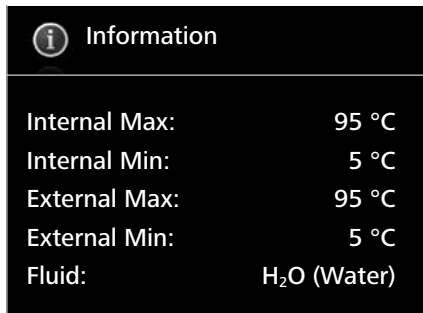

Fig. 5

Then the working screen in standby status appears and the device is ready for operation.

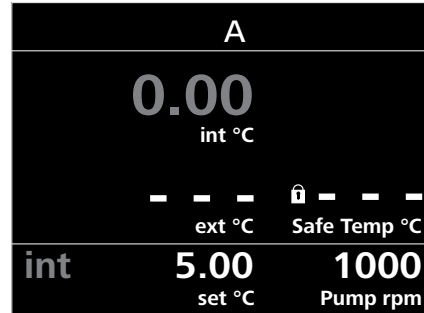

Fig. 6

Change the temperature setting with “Temp (+)” button (E) or “Temp (-)” button (F).

Change the pump speed setting with “Pump (+)” button (H) or “Pump (-)” button (I).

In standby status, activate the heating function by pressing the “Temp” button (D). The device start heating function, meanwhile the pump start to run.

In working status, stop the pump function by pressing the “OK/Pump” button (G). The heating function and pump stops.

In standby status, press the “OK/Pump” button (G) to start the pump function. The heating function will not be activated.

In running status, press the “Temp” button (D) to stop the heating function, the pump keep running.

The control elements of the device allow to be locked by pressing the key button (O), so no accidental changes during operation are possible (key symbol appears in the display).

By pressing the key button (O) again, the controls are released (key symbol disappears from the display).

Setting the safety temperature

Adjust the safety temperature with screwdriver included with the device.

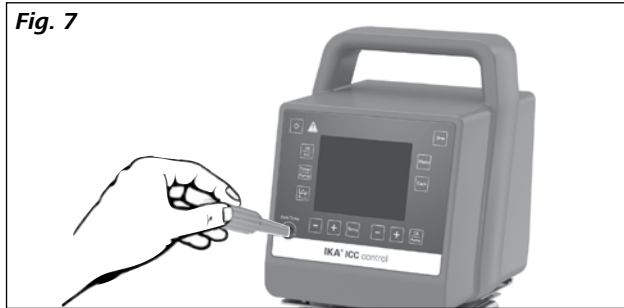

The safety temperature setting will appear on the display.

Factory setting: maximum value

Adjustment range: 0 – 160 °C

Note: The safe temperature limit must always be set to at least 25 °C lower than the flash point of the fluid used.

Operation

• Working screen at the time of delivery:

The start and information screen (see section "**Commissioning**") appears for a few seconds after the device is switched on. After this, the following working screen appears automatically in the display.

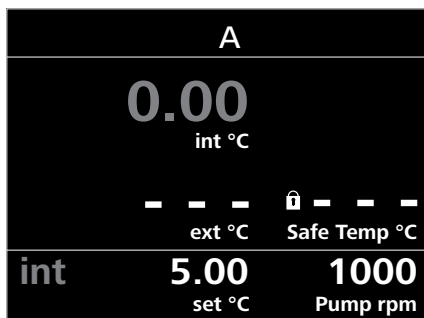

Fig. 8

• Explanation of symbols on the working screen:

The symbols displayed change depending on the status and settings of the device. The screen below shows the most significant symbols on the working screen.

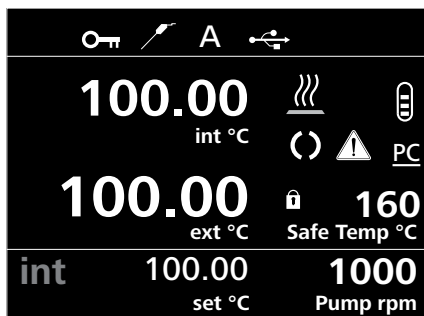

Fig. 9

🔑 Lock:

This symbol means that the function of the keys for controlling the device are disabled. The symbol no longer appears if the functions are enabled once again by pressing the key button a second time.



Temperature Sensor:

This symbol appears when the external temperature sensor is connected.

A Operating Mode:

This symbol indicates the operating mode currently selected (A, B, C, D).



USB:

This symbol means the device is communicating with a PC via a USB cable.





Heating

This symbol indicates that the heating function is active. $\rightsquigarrow \rightsquigarrow \rightsquigarrow$ indicate active heating process.



Fluid level

This symbol indicates fluid level. The red symbol  means the fluid is above the maximum fluid level. Excess fluid should be drained out. The red symbol  means the fluid is below the minimum fluid level. Please add fluid.



Pump:

This symbol indicates that the pump is activated.



Warning:

This symbol indicates that warning is active.

PC PC Control:

This symbol means that the device is connected to a computer and is being controlled from the computer.

PR Program Control:

This symbol indicates that the device is controlled by a program (see "**PROGRAMS**").

• **Menu navigation and structure:**

Menu navigation

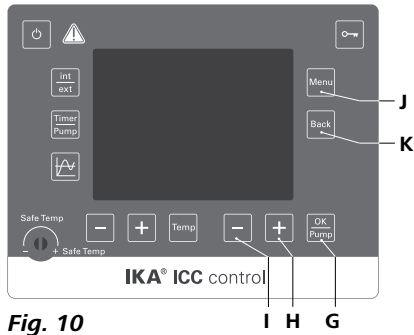

- ☞ Press the **"Menu"** key (J).
- ☞ Select the menu option by pressing the **"Pump (+)"** button (H) or **"Pump (-)"** button (I).
- ☞ Open the menu item by pressing the **"OK/Pump"** button (G).
- ☞ Press the **"Pump (+)"** button (H) or **"Pump (-)"** button (I) to select the desired menu option and edit the values or settings.
- ☞ Press the the **"OK/Pump"** button (G) to get into sub menu items to active/inactive to switch settings or to confirm settings ("OK").
- ☞ Press the **"Back"** button (K) to a setting or cancel to return to the previous menu.
- ☞ Press the **"Menu"** button (J) to return directly to the working screen.

Fig. 10

Note: When the tempering or pump functions are active, the menu is locked. On the display, the active menu option is highlighted in yellow. The active status of a menu item is marked with a check (✓).

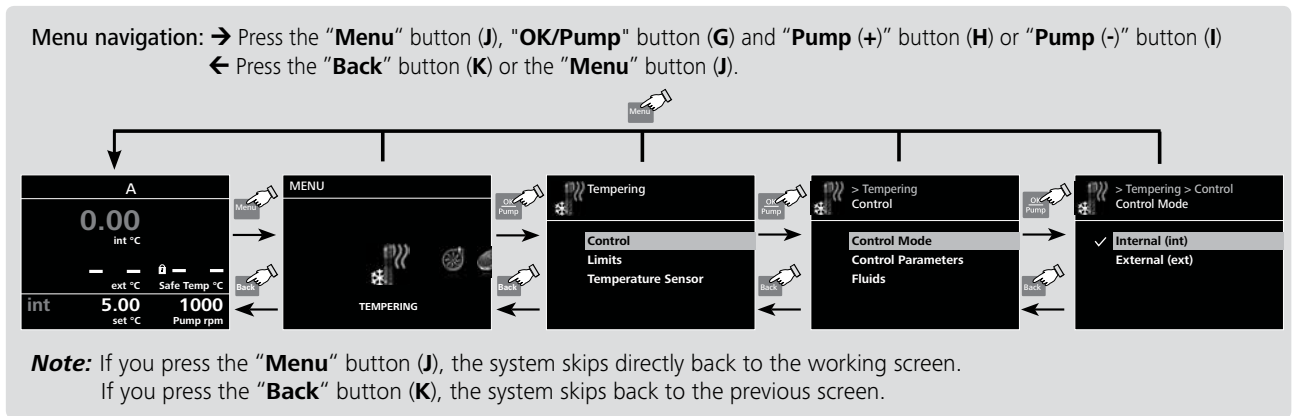

Fig. 11

Menu structure:

		Factory Settings		
Menu	TEMPERING	Control	Control Mode	Internal (int) activated
			Control Parameters	External (ext) -
			Automatic	Accurate activated
		Fluids	Manual	Fast -
			Internal (Kp, Ti, Td, Ts, Prop_Bp, Prop_Bn) 60.0, 5.0, 0.3, 3 s, +1.00 K, -1.00 k	
			External (Kp, Ti, Td, Ts, Prop_Bp, Prop_Bn) 11.0, 15.0, 0.0, 90 s, +1.00 K, -1.00 k	
			Information (Kp, Ti, Td, Ts, Prop_Bp, Prop_Bn) -	
			CF.EG28.N10.80.8 -	
			CF.EG39.N20.80.16 -	
			CF.EG44.N25.80.19 -	
			CF.EG48.N30.80.22 -	
			UF.Si.N30.150.10LV -	
			HF.Si.20.200.50 -	
			HF.Si.20.250.50A -	
			H ₂ O (Water) activated	
	Customized 1 -			
	Customized 2 -			
	Limits	External (ext)	Maximum 95 °C	
		Δ T (int - ext)	Minimum 5°C	
		Power Output	Heating 100 °C	
	Temperature Sensor	Calibration	Internal	2 Point Calibration -
			3 Point Calibration -	
		External	2 Point Calibration -	
		3 Point Calibration -		
	Reset Calibration	Internal -		
		External -		
	Notification	ON -		
		Hysteresis ± 0.0 K		
		Sound	Infinite activated	
	Beep -			
	PUMP	Limits	Speed	Maximum 3200 rpm
			Minimum 1000 rpm	
			Pressure	Maximum 10.4 bar
	TIMER	Set 00:00 [hh:mm]		
		Display -		
	MODE	A activated		
		B -		
		C -		
		D -		
	DISPLAY	Main Screen	Pump activated	
			Timer -	
	GRAPH	Automatic	Axis Assignment	Set Temperature activated
			Actual Internal Temp. activated	
		Manual	Axis Scaling	Actual External Temp. activated
			X - Axis	15 min -
30 min -				
60 min -				
120 min -				
Y - Axis	Maximum 95 °C			
Minimum 5 °C				
PROGRAMS	Program 1 -			
	Program 10 -			
OUTGAS	Speed 1000 rpm			
	Interval 10 s			
SAFETY	Password 000			
	Safe Temp. Confirmation -			
SETTING	Languages	English activated		
		Deutsch -		
	Display	Background	Black activated	
		White -		
	Firmware Update Info -			
	Sound	Key Tone -		
	Factory Settings -			
	Communication	Device Name Circulator		
	Information	Tempering yes		
		Pump yes		
Safety yes				
Software yes				
Intro yes				
Firmware Update Info yes				

• **Menu (Details):**



TEMPERING:

Control:

Control Mode:

Internal (int): The temperature is regulated according to the internal temperature sensor.

Extern (ext): The temperature is regulated according to the external temperature sensor.

Control parameters:

Automatic: The optimal control parameters for PID temperature control are determined automatically. This is the recommended mode.

Selecting "**Automatic**" allows you to set the dynamics for temperature control:

Accurate: precise tempering without overshooting.

Fast: fast tempering with minimal overshooting.

Manual: The control parameters for PID temperature control can be set manually.

"**Manual**" should only be used in the event of special temperature control requirements.

When "**Manual**" is selected, the following parameters can be set for "**Internal (int)**" and "**External (ext)**" temperature control:

Kp: Proportional coefficient

The proportional coefficient **Kp** is the controller amplification and determines how strongly the control deviation (the difference between the target temperature and actual temperature) directly affects the control variable (on-time of the heater). **Kp**-values that are too large can lead to the controller overshooting.

Ti: Integral time

The integral time **Ti** (s) is the correction time and determines how strongly the duration of the control deviation affects the control variable. **Ti** compensates for an existing control deviation. A high **Ti** means a smaller and slower effect on the control variable. **Ti**-values that are too small can lead to instability of the controller.

Td: Differential time

The differential time **Td** (s) is the derivative time and determines how strongly the rate of change of the control deviation affects the control variable. **Td** compensates for rapid control deviations. A high **Td** means a smaller and slower effect on the control variable. **Td**-values that are too large can lead to instability of the controller.

Ts: Sampling time

The sampling time **Ts** (s) is the time interval over which the control deviation is determined and the respective control variable (dependent on **Kp**, **Ti** and **Td**) is calculated.

Ts must be adjusted to match the response characteristic (total of all time constants) of the closed loop controlled system, so that the control variable can deliver a uniform and measurable change in the control deviation. **Ts** values that are too small or too large can lead to instability of the controller.

Fluids:

Under the option "**Fluids**", a variety of heat transfer fluids can be selected.

The selected fluid limits the setting range of the target temperature. See table in the section "**Fluids**".

The maximum and minimum temperature values of the selected fluid can be set within these limitations.

Limits:

Under the option "**External (ext)**", the maximum and minimum temperature for external temperature control can be set.

Under "**I Δ T (int - ext) I**", the maximum difference between the internal and external temperature can be set.

Under "**Power Output**", the maximum heating output can be set as a percentage.

Temperature sensor

The internal and external temperature measurement can be calibrated and compensated for.

By "calibration (Reset Calibration)", the calibration value for the internal or the external temperature sensor will be deleted.

Notification:

ON:

This menu option allows you to activate/deactivate the "Notification" function. A green check mark and a beep informing when the target value (hysteresis) has been reached.

Hysteresis:

This menu option allows you to set the hysteresis from 0 to ± 2.0 K.

Sound:

Infinite: Beep until you press the "Back" key.

Beep: Single beep.



PUMP

Limits:

In "**Limits**" option, the user is allowed to set the maximum and minimum speed to the pump, and also the maximum pressure.



TIMER

Set:

The user can set a target time (duration).

When device functions are started normally, this time is displayed on the working screen. The device functions stop automatically once this time has expired. The running time is then displayed again on the display.

Note: To deactivate the target time specification, set the target time to 00:00.

Display:

Activate the timer display on the main display (working screen).



MODE

Operating Mode A:

After power-on/power failure no automatic restart of functions.

Operating Mode B:

After power-on/power failure automatic restart of functions, depending on previous settings.

Operating mode C:

Set values (set in **A** or **B**) cannot be changed.

After power-on/power failure automatic restart of functions, depending on previous settings.

Operating mode D:

Confirmation request for set value changes, if functions are active. After power-on/power failure no automatic restart of functions.



DISPLAY

In the "Display" menu the user can specify what information will be displayed on the screen.



GRAPH

In this menu, you can set the options for the time-temperature diagram.

Automatic:

The scaling of the temperature axis (Y-axis) is automatically determined, depending on the target temperature and the actual internal and external temperature.

The time axis (X-axis) is permanently scaled to 30 minutes.

Manual:

Axis Assignment:

The temperature values to be displayed can be selected.

Axis scaling:

Scaling of the time (X) and temperature axis (Y) can be selected or set.



PROGRAMS

Under programs, 10 user-defined temperature-time profiles can be created. A program can consist of up to 10 segments.

Once a program has been selected, the following options are available:

Start:

Starts the program upon request of loop mode.

Infinite loop: Upon completion of the last segment, the program continues with the first segment until the user ends the program by stopping a device function.

Loop Count: Indicates the total number of loop cycles until program end.

Note: At the end of the program all device functions are switched off.

Edit:

Edit/change program parameters.

Seg No.: Segment number.

Ctrl. Sensor (int/ext): Determines whether control is through the internal (int) or external (ext) temperature sensor.

Temp.: Target temperature.

Ctrl.Mode (Time / +/- x.x K): In "Ctrl.Mode Time" the target values and settings of the segment are valid for the duration indicated in the column "Time hh:mm".

Afterwards, the next program segment is automatically executed.

In "Ctrl.Mode +/- x.xx K", the hysteresis (tolerance) of the actual temperature to the target temperature is set (e.g. +/- 0.1 K). The target values and settings of the segment are valid until the actual temperature reaches the target temperature +/- hysteresis for the first time.

Afterwards, the next program segment is automatically executed.

Pump rpm: Target speed of pump.

Delete:

Deletes the selection highlighted in yellow (segment or program).

Insert: Inserts a new program segment after the selected segment.

Save: Saves changes.

View:

Temperature-time overview displays for the program with segments of the selected program.

Note: If hysteresis is set as "Ctrl.Mode +/-x.xx K" for one or more segments in the program, the duration of the program cannot be determined.

Press the "Pump (+)" button (H) or "Pump (-)" button (I) and "OK/Pump" button (G) to display the segment details.

Cancel: Cancels the process.

Note: Once the program has been started, the program no., segment no. (active/total) and the remaining duration of the segment or hysteresis are displayed in the graph.



OUTGAS

In the option, the user is allowed to set the outgas speed in range of 1000 rpm to 3200 rpm and outgas interval from 10 seconds to 240 seconds.

This function can be used when filling external devices such as laboratory reactors.



SAFETY

Password:

In the "Password" menu, the menu settings can be locked by a 3-digit password.

Safe Temp. Confirmation:

This menu can confirm (safety temperature of the station) at start-up of the set "Safe Temp". A check mark (✓) indicates that the function is activated.



SETTING

Languages:

The "Languages" option allows the user to select the desired language.

Display:

The "Display" option allows the user to change the background color of the working screen.

You can also activate the "Firmware Update Info" screen in this menu.

Sound:

The "Sound" option allows the user to activate/deactivate the key tone.

Factory Settings:

Select the "Factory settings" option with "OK/Pump" button. The system requests confirmation to restore the factory settings. Pressing the "OK" button resets all the system settings to the original standard values set at dispatch from the factory (see "Menu structure").

Communication:

The "Device name" menu option allows you to edit the device name.

Information:

The "Information" option offers the user an overview of the most important system settings of the device.

Interface and output

The device can be operated in "Remote" mode via the RS 232 interface (10) or the USB interface (11) connected to a PC and with the laboratory software Labworldsoft®. The device software can also be updated with a PC via the USB or RS 232 interface.

Note: Please comply with the system requirements together with the operating instructions and help section included with the software.

USB interface:

The Universal Serial Bus (USB) is a serial bus for connecting the device to the PC. Equipped with USB devices can be connected to a PC during operation (hot plugging). Connected devices and their properties are automatically recognized.

USB device drivers:

First, download the latest driver for IKA devices with USB interface from:

<http://www.ika.com/ika/lws/download/usb-driver.zip>.

Install the driver by running the setup file. Then connect the IKA device through the USB data cable to the PC.

The data communication is via a virtual COM port. Configuration, command syntax and commands of the virtual COM ports are as described in RS 232 interface.

Note: the USB driver is unnecessary for Windows 10 system. Don't install it for Windows 10 system!

RS 232 interface:

Configuration

- The functions of the interface connections between the device and the automation system are chosen from the signals specified in EIA standard RS 232 in accordance with DIN 66 020 Part 1.
- For the electrical characteristics of the interface and the allocation of signal status, standard RS 232 applies in accordance with DIN 66 259 Part 1.
- Transmission procedure: asynchronous character transmission in start-stop mode.
- Type of transmission: full duplex.
- Character format: character representation in accordance with data format in DIN 66 022 for start-stop mode. 1 start bit; 7 character bits; 1 parity bit (even); 1 stop bit.
- Transmission speed: 9600 bit/s.
- Data flow control: none
- Access procedure: data transfer from the device to the computer takes place only at the computer's request.

Command syntax and format:

The following applies to the command set:

- Commands are generally sent from the computer (Master) to the device (Slave).
- The device sends only at the computer's request. Even fault indications cannot be sent spontaneously from the device to the computer (automation system).
- Commands are transmitted in capital letters.
- Commands and parameters including successive parameters are separated by at least one space (Code: hex 0x20).

- Each individual command (incl. parameters and data) and each response are terminated with Blank CR Blank LF (Code: hex 0x20 hex 0x0d hex 0x20 hex 0x0A) and have a maximum length of 80 characters.
- The decimal separator in a number is a dot (Code: hex 0x2E).

The above details correspond as far as possible to the recommendations of the NAMUR working party (NAMUR recommendations for the design of electrical plug connections for analogue and digital signal transmission on individual items of laboratory control equipment, rev. 1.1).

The NAMUR commands and the additional specific **IKA** commands serve only as low level commands for communication between the device and the PC. With a suitable terminal or communications programme these commands can be transmitted directly to the device. The **IKA** software package, Labworldsoft®, provides a convenient tool for controlling the device and collecting data under MS Windows, and includes graphical entry features, for motor speed ramps for example.

Commands:

Commands	Function
IN_PV_1	Read the external actual temperature
IN_PV_2	Read the internal actual temperature
IN_PV_3	Read the safety actual temperature
IN_PV_4	Read the pump actual speed
IN_SP_1	Read the internal setting temperature (if 0: internal control) Read the external setting temperature (if 1: external control)
IN_SP_3	Read the safety setting temperature
IN_SP_4	Read the pump setting speed
IN_TMODE	Read temperature control 0: internal control 1: external control
OUT_SP_1 xxx	Set the internal setting temperature XXX (if 0: internal control) Set the external setting temperature XXX (if 1: external control)
OUT_SP_12@n	Set the WD safety temperature with echo of the set (defined) value.
OUT_SP_4 xxx	Set the pump speed XXX
OUT_SP_42@n	Set the WD-safety speed with echo of the set (defined) value.
OUT_TMODE_0	Set to Internal temperature control
OUT_TMODE_1	Set to External temperature control
OUT_WD1@n	Start the watchdog mode 1 and set the time for the watchdog to n (20...1500) seconds. Echo of the Watchdog time. During a WD1-event, the heating and pump functions are switched off. This command needs to be send within the watchdog time.
OUT_WD2@n	Start the watchdog mode 2 and set the watchdog time to n (20...1500) seconds. Echo of the watchdog time. During a WD2-event, the set temperature is changed to the WD safety temperature and the pump set speed is set to the WD safety speed. This command needs to be send within the watchdog time.
RESET	Reset the PC control and stop the device functions.
START_1	Start the heating function
START_4	Start the pump function
STOP_1	Stop the heating function
STOP_4	Stop the pump function

PC 1.1 Cable:

This cable is required to connect RS 232 port (10) to a PC.

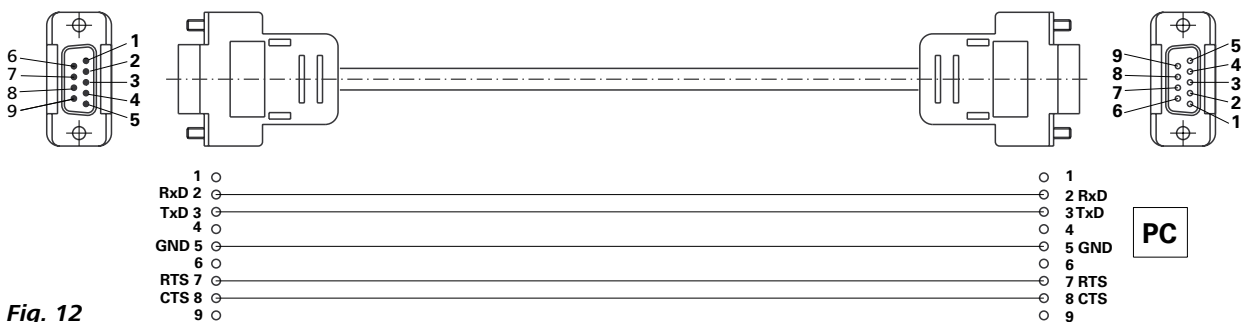

Fig. 12

USB 2.0 cable (A - Micro B):

This cable is required to connect USB port (11) to a PC.

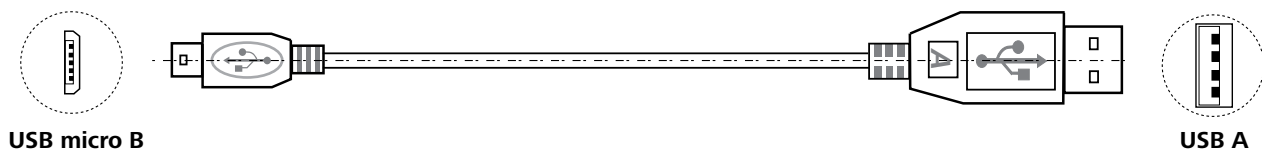

Fig. 13

Device software update:

Keep your device up-to-date with the **IKA** Firmware update tool.

The firmware update can be done with a computer connected through USB-Interface or RS 232 interface.

For this, you need register on our website MyIKA first.

After registering your device **IKA** will inform you about available updates for your devices.

Please download the software "FWUToolSetup.zip" from our **IKA** service website www.ika.com.

Maintenance and cleaning

The device is maintenance-free. It is only subject to the natural wear and tear of components and their statistical failure rate.

Cleaning:

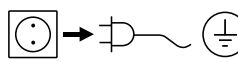
 For cleaning disconnect the mains plug!

Use only cleaning agents which have been approved by **IKA** to clean the devices:

These are: water (containing surfactant) and isopropyl alcohol.

- Wear protective gloves while cleaning the device.
- Electrical devices may not be placed in the cleansing agent for the purpose of cleaning.
- Do not allow moisture to get into the device when cleaning.
- Before using another than the recommended method for cleaning or decontamination, the user must ascertain with **IKA** that this method does not damage the device.

Spare parts order:

When ordering spare parts, please give:

- machine type
- manufacturing number, see type plate
- item and designation of the spare part, see www.ika.com, spare parts diagram and list
- Software version.

Repair:

Please send the device for repair only after it has been cleaned and is free from any materials which may constitute a health hazard.

For repair, please request the "Decontamination Certificate" from **IKA**, or download printout of it from the **IKA** website www.ika.com.

If you require servicing, return the device in its original packaging. Storage packaging is not sufficient. Please also use suitable transport packaging.

Error codes

Any malfunctions during operation will be identified by an error message on the display.

Proceed as follows in such cases:

- ☞ Switch off device using the main switch at the back of the device
- ☞ Carry out corrective measures
- ☞ Restart device

Error code	Effect	Cause	Solution
Error 01	Pump off Heating off	No external temperature sensor	Check this sensor
Error 02	Pump off Heating off	Motor over current (rate current)	- Reduce pump motor speed - Use fluid with lower viscosity - Check if the pump impeller is blocked
Error 03	Pump off Heating off	Motor over current (max current)	- Reduce pump motor speed - Use fluid with lower viscosity - Check if the pump impeller is blocked
Error 04	Pump off Heating off	Motor hall signal missing	- Reduce pump motor speed - Use fluid with lower viscosity - Check if the pump impeller is blocked
Error 05	Pump off Heating off	Too high liquid level	- Check the liquid level and buoyage
Error 06	Pump off Heating off	Too low liquid level	- Check the liquid level and buoyage
Error 07	Pump off Heating off	Too high voltage	- Check the mains power
Error 08	Pump off Heating off	Too low voltage	- Check the mains power
Error 09	Pump off Heating off	Device internal temperature is too high	- Check the ambient temperature and let the device cool down
Error 10	Pump off Heating off	PC communication failure	- Check communication cable
Error 11	Pump off Heating off	Temperature difference between control sensor and safety sensor is too much	- Check safety temperature circuit and bath fluid
Error 12	Pump off Heating off	Safety temperature alarm	- Check the bath temperature measurement
Error 13	Pump off Heating off	Heater switched off by safety circuit	- Check safety temperature set value, liquid level
Error 14	Pump off Heating off	Fan error	- Check the fan and clean the grids at the rear side

If the actions described fails to resolve the fault or another error code is displayed then take one of the following steps:

- Contact the service department
- Send the device for repair, including a short description of the fault.

Accessories

- **Tubing, hoses, adapters and couplings**
 - LT 5.20** Metal hose (isolated M16 x 1)
 - LT 5.21** PTFE hose (isolated M16 x 1)
 - H.PVC.8** PVC hose (nominal width 8)
 - H.PVC.12** PVC hose (nominal width 12)
 - H.SI.8** Silicone hose (nominal width 8)
 - H.SI.12** Silicone hose (nominal width 12)
 - **Tubing Insulations**
 - ISO. 8** Insulation (8 mm)
 - ISO.12** Insulation (12 mm)
 - **Bath vessels**
 - IB eco 8** Plastic bath (8 litre)
 - IB eco 18** Plastic bath (18 litre)
 - IB pro 9** Stainless steel bath (9 litre)
 - IB pro 12** Stainless steel bath (12 litre)
 - IB pro 20** Stainless steel bath (20 litre)
 - **Bridges and Covers**
 - BS.ICC** Small bridge (for **IB eco 8, IB pro 9**)
 - BL.ICC** Large bridge (for **IB eco 18, IB pro 12, IB pro 20**)
 - CS.ICC** Small cover (for **IB eco 8, IB pro 9**)
 - CM.ICC** Medium cover (for **IB pro 12**)
 - CL.ICC** Large cover (for **IB eco 18, IB pro 20**)
 - **Additional accessories**
 - PCS.ICC** Pump set
 - Pt 100.3** Temperature sensor
 - PC 1.1** Cable (RS 232)
- Labworldsoft®**

See more accessories on www.ika.com.

Technical data

Nominal voltage	VAC	230 ± 10 % / 115 ± 10 % / 100 ± 10 %
Frequency	Hz	50 / 60
Max. input Power	W	2100 (230 VAC) / 1100 (115 VAC) / 860 (100 VAC)
Working temperature range (RT+10 °C at 1000rpm)	°C	RT + 10 ... 150
Operating temperature range (with external cooling)	°C	- 20 ... 150
Temperature stability – Internal temperature control 70 °C, water (according to DIN12876)	K	± 0.01
Temperature control		PID (Automatic/user setting)
Temperature measurement, absolutely accuracy: Internal (int) (adjustable by calibration)	K	± 0.2
External (ext) (adjustable by calibration)	K	± 0.2
External Pt 100.3 temperature sensor tolerance to DIN EN 60751 class A, ≤ ± (0.15 + 0.002 x T), e.g. at max. 100°C (adjustable by calibration)	K	± 0.35 (at 100°C)
Temperature setting		Button
Temperature setting resolution	K	0.1
Temperature display		TFT LCD
Temperature display resolution	K	0.01
Classification according to DIN 12876-1		Class III (FL) suitable for flammable and non-flammable fluids
Safety circuit (adjustable)	°C	0 ... 160
Safety temperature display		TFT LCD
Heating capacity	W	2000 (230 VAC) / 1000 (115 VAC) / 760 (100 VAC)
Pump speed (adjustable)	rpm	1000 ... 3200
Max. pump pressure/suction	bar	0.3 / 0.2
Max. flow rate (at 0 bar)	l/min	18
Sub-level protection		Yes
Interface		RS 232, USB
Permitted on-time	%	100
Protection class according to EN 60529		IP 21
Protection class		I
Excess voltage category		II
Contamination level		2
Permitted ambient temperature	°C	+ 5 ... + 40
Permitted ambient humidity (relative)	%	80
Dimension (W x D x H)	mm	145 x 200 x 340
Weight	kg	3.8
Operation at a terrestrial altitude	m	max. 2000

Note: Complies to EN 61000-3-11 subject to conditional connection: $Z_{max} = 0.282 \Omega$. If necessary, consult your electricity supplier.

Subject to technical changes!

Warranty

In accordance with **IKA** warranty conditions, the warranty period is 24 months. For claims under the warranty please contact your local dealer. You may also send the machine direct to our factory, enclosing the delivery invoice and giving reasons for the claim. You will be liable for freight costs.

The warranty does not cover worn out parts, nor does it apply to faults resulting from improper use, insufficient care or maintenance not carried out in accordance with the instructions in this operating manual.

Pump performance curve

Pump performance curve measured with water:

(Measurements done according DIN 12876-2 with water at 20°C; pump in a closed-loop circuit).

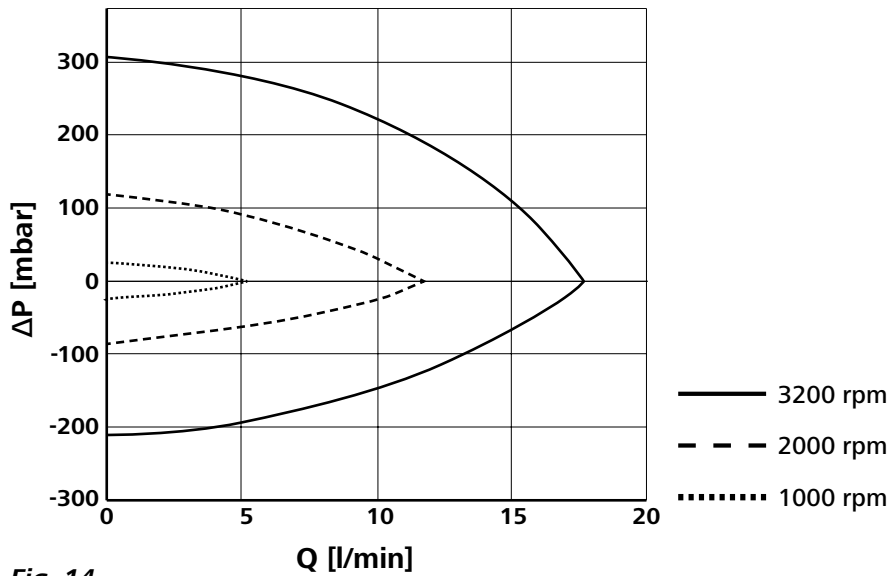

Fig. 14

IKA

designed for scientists

IKA-Werke GmbH & Co. KG

Janke & Kunkel-Straße 10, 79219 Staufen, Germany

Phone: +49 7633 831-0, Fax: +49 7633 831-98

eMail: sales@ika.de

USA

IKA Works, Inc.

Phone: +1 910 452-7059

eMail: usa@ika.net

KOREA

IKA Korea Ltd.

Phone: +82 2 2136 6800

eMail: sales-lab@ika.kr

BRAZIL

IKA Brazil

Phone: +55 19 3772 9600

eMail: sales@ika.net.br

MALAYSIA

IKA Works (Asia) Sdn Bhd

Phone: +60 3 6099-5666

eMail: sales.lab@ika.my

CHINA

IKA Works Guangzhou

Phone: +86 20 8222 6771

eMail: info@ika.cn

POLAND

IKA Poland Sp. z o.o.

Phone: +48 22 201 99 79

eMail: sales.poland@ika.com

JAPAN

IKA Japan K.K.

Phone: +81 6 6730 6781

eMail: info_japan@ika.ne.jp

INDIA

IKA India Private Limited

Phone: +91 80 26253 900

eMail: info@ika.in

UNITED KINGDOM

IKA England LTD.

Phone: +44 1865 986 162

eMail: sales.english@ika.com

VIETNAM

IKA Vietnam Company Limited

Phone: +84 28 38202142

eMail: sales.lab-vietnam@ika.com

Discover and order the fascinating products of IKA online:
www.ika.com



IKAworldwide



IKAworldwide /// #lookattheblue



@IKAworldwide