

INSTRUCTION MANUAL
ELECTRONIC MOISTURE BALANCE
MOC-120H



READ AND UNDERSTAND THIS MANUAL BEFORE OPERATION.
SAVE THIS MANUAL.

 **SHIMADZU CORPORATION**
KYOTO JAPAN

ANALYTICAL & MEASURING INSTRUMENTS DIVISION

Requests

- Provide this manual to the next user in the event that the instrument is transferred.
- To ensure safe operation, contact your Shimadzu Balance representative for installation, adjustment, or reinstallation after moving the instrument to a different site.

Notices

- The content of this manual is subject, without notice, to modifications for the sake of improvement.
- Every effort has been made to ensure that the content of this manual was correct at the time of creation. However, in the event that any mistakes or omissions are discovered, it may not be possible to correct them immediately.
- The copyright of this manual is owned by Shimadzu Corporation. Reproduction and duplication of whole or part of the content without permission of the company are strictly prohibited.
- "Microsoft", "Windows" and "Excel" are registered trademarks of Microsoft Corporation of the U.S.A. in the United States and other countries. All other company names and product names that appear in this manual are trademarks or registered trademarks of the companies concerned. Note that ™ and ® indications are not used.
- The company names, organization names and product names in this manual are trademarks or registered trademarks of the companies and organizations concerned.
- Shimadzu does not guarantee that the WindowsDirect communication function will operate without problems on all PCs. Shimadzu will accept no responsibility for any trouble that arises as a result of using this function. You are recommended to back up all important data and programs in advance.

© 2004-2018 Shimadzu Corporation. All rights reserved.

Electronic Moisture Balance Safety Notes

Improper use of the electronic moisture balance in violation of the following safety notes may result in death, injury or damage to property due to fire, etc. Furthermore, the electronic moisture balance has high temperature components which can cause burns if proper safety guidelines are not followed.

■ Observe all safety guidelines



Carefully read and observe all safety notes included in this user's manual.

■ Do not use the unit if it appears to be malfunctioning

If you suspect a problem or malfunction in the unit, discontinue use and immediately have the unit inspected by certified service personnel.

■ Meanings of Warning Indicators and Symbols

The following symbols are used in this operating manual and product to prevent accidents from occurring as a result of improper usage or handling. The meaning of each symbol is as described below.

 Warning	Failure to observe these items may lead to death or injury to the user.
 Caution	Failure to observe these items may lead to injury to the user or damage to property.
 Note	Items which the user should be aware of in order to use the unit safely.

Caution Symbols



Fire Hazard



Burn Hazard



Electric Shock Hazard

Prohibition Symbols



Prohibited



Do Not Disassemble



Do not Expose to Water

Symbol Requiring User Action









Required Action



Disconnect Plug from Electrical Outlet

 Warning		
	Fire Hazard	Electric Shock Hazard

-  Do not attempt to measure samples which may undergo dangerous chemical reactions when heated as doing so may result in explosion or release of toxic gas.
-  Do not place flammable materials near the electronic moisture balance. Some parts of the electronic moisture balance become extremely hot during operation and could lead to fire if flammable materials are placed nearby. The heater inside the Electronic Moisture Balance reaches temperatures higher than the preset sample-heating temperature. The surface of the quartz tube of the heater reaches approximately 500°C (900°F) even during normal measurements. In addition, the nickel-chromium resistance wire inside the heater reaches approximately 900°C (1700°F) and is not airtight.
-  Never use with any power source for which the product was not designed. Application of excessively high voltage may result in overheating to malfunction or fire.
-  To prevent electric shock and to maintain stability in operation of the product, be sure to ground the product. The product will be grounded when its power plug is inserted into a 3-wired power socket equipped with a ground terminal.
-  Do not attempt to disassemble, modify or rebuild the electronic moisture balance. Doing so may result in accident, electric shock, etc. If you believe the unit may be malfunctioning contact to an authorized Shimadzu representative.
-  Do not use the electronic moisture balance and peripherals (connected PC or Printer) in a location where it can be splashed with water. Doing so may result in an electric shock or lead to abnormal operation.

 Caution		
	Burn Hazard	Electric Shock Hazard

- Do not touch the heat-dispersing component of the heater cover or sample pan with your bare hands, as doing so might result in burns. This electronic moisture balance is at high temperature during and immediately after making measurements. When touching the unit, only use the specified control knobs and accessories.

Follow operation instruction

- Correctly set draft shield, sample pan supporter, sample pan handler and sample pan.



- Hold the handle of heater lid when opening or closing heater lid.



- Use sample pan handler when removing sample pan.



- Never touch any metal parts of heater unit and surrounding parts when removing sample pan.



- Cool the unit down to ambient temperature in a safe location after measurement.



- Always make sure that the unit has cooled down sufficiently before covering it with a dust cover.



Warning on high temperature



- The shadowed parts become especially hot during measurement. Only handle the parts marked with circles when operating.

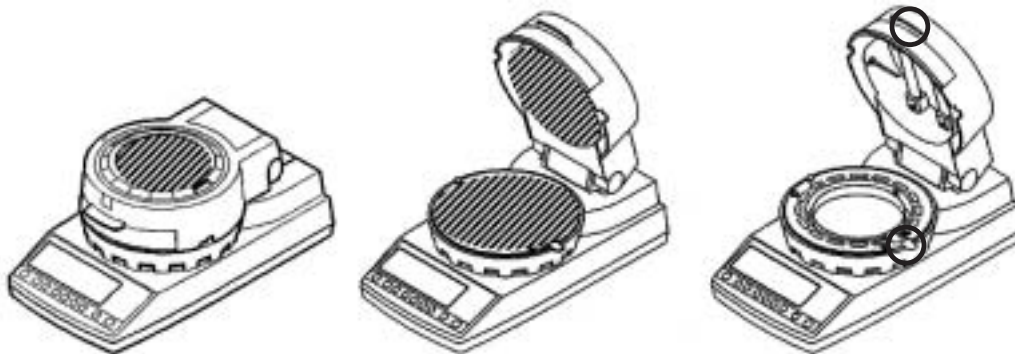

Do not measure hazardous samples



- Use the Electronic Moisture Balance only for measuring the moisture content in a sample by moisture evaporation through the heating process.







- Set the drying temperature within the safe temperature range of each sample.







- The heater inside the Electronic Moisture Balance reaches temperatures higher than the preset sample-heating temperature.

The surface of the quartz tube of the heater reaches approximately 500°C (900°F) even during normal measurements. In addition, the nickel-chromium resistance wire inside the heater reaches approximately 900°C (1700°F) and is not airtight. Measurements of combustible or flammable samples pose a risk of fire.

-  ● Do not measure any sample which might explode, ignite or produce toxic substances under high temperature.
-  ● Do not measure any sample which might cause chemical reaction under high temperature.
-  ● Do not measure any sample of unknown property.
-  ● Do not measure any sample whose surface hardens or solidifies by heating causing high inner pressure.
-  ● Immediately turn the power off if the sample should catch fire during measurement.
- Use with adequate ventilation and appropriate venting for sample type.

Do not place flammable objects near the unit

-  ● The unit becomes very hot during and after measurements. Do not place any flammable objects near it as they may catch fire.
-  ● Do not place near any objects which are not heat resistant. They may be damaged or deformed.
-  ● Never place anything on top of the heater unit.
-  ● Immediately turn the power off and disconnect power cable when any emergency occurs, such as abnormal smell, smoke or fire.





Key and Power Switch Operation

- Do not turn the power on while pressing any keys.
- Do not operate any keys except as instructed in this manual.
-  ● Turn the power off and disconnect power cable when lightning is expected.

Emergency Stop

-  ● [Start/Stop] key is always effective during measurement. Press it immediately when any danger or abnormality occurs.

Installation, Transportation and Storage

- Avoid locations subject to extremely high or low temperature, high humidity, direct sun light, electro-magnetic noise, corrosive gas or dust.
- Do not use the device outdoors.
- Install on a vibration-free, level surface.
- For transportation, hold the unit level as much as possible.
-  ● Do not drop or impact the unit.
-  ● Do not pull the cable - hold the connector when disconnecting the power cable or RS-232C cable.
-  ● Do not place anything which may interfere the unplugging operation near the mains connector of the power supply cable.
-  ● Turn the power switch off and disconnect from the power source when not using for a long time or lighting is expected.

Others

- After a power outage, turn the power back ON.
When a power outage occurs, the power is shut off automatically. Therefore, once turn off the power switch, then begin operation from 7.① "Turn on the power switch" (☞ page 12) again.
- Do not connect anything other than peripheral devices specified by Shimadzu to the moisture balance's connector.
If you do, the balance may stop working normally.
In order to avoid trouble, always connect peripheral devices in accordance with the directions in this manual.
- If you detect anything abnormal (e.g. a burning smell) disconnect the AC power cord immediately.
Continuing to use the balance with an abnormality could lead to fire or an electric shock.

Contents

1. Introduction	1
2. Description of Features and Principles of Operation	2
2-1 Principles of Operation	2
2-2 Features	2
2-3 Applications (i.e., materials which can be measured)	2
3. Specifications	3
4. Names of Individual Parts and Components	4
4-1 Names of Parts of Main Unit	4
4-2 Parts and Accessories	5
5. Display and Control Panel	6
5-1 Display	6
5-2 Control Panel Operations	7
6. Assembly and Installation of Main Unit	8
7. How to Conduct Measurements	12
8. Specifying Measuring Conditions	15
8-1 Selecting Temperature Display Mode	15
8-2 Types of Settings	16
8-3 Descriptions of Individual Measuring Condition Settings	16
8-3-1 Selecting the CONDITIONS (Measuring conditions storage area)	17
8-3-2 Selecting the MODE (Measuring mode)	18
8-3-3 TEMP (Drying temperature) Setting	27
8-3-4 Bias Setting	28
9. Menu Settings	29
9-1 Types of Menu Settings	29
9-2 Descriptions of Individual Menu Items	29
9-2-1 Selecting a measurement base and switching the % display	30
9-2-2 Specifying the type and format of output	31
9-2-3 Specifying sample codes	34
9-2-4 Setting the date and time	35
9-2-5 CAL (Balance calibration)	36
9-2-6 Specifying a device ID	37
9-2-7 Specifying a password	38

10. Error Messages	39
11. Precaution on Conducting Measurements	40
12. Predictive Measurements	41
12-1 A Description of Predictive Measuring	41
12-2 Procedure for Obtaining Predicted Measurements	43
12-2-1 Calculating the bias to be specified when operating in predictive measurement mode	43
12-2-2 Evaluating Predictive measurements	45
12-2-3 Performing Predictive measurements	46
13. Temperature Calibration (Option required)	47
14. Printing Output to a Printer (Option)	49
14-1 Printer Output Sample	49
14-2 Outputting Stored Measurement Data	52
15. Computer Interface	53
15-1 RS-232C Interface Specifications	53
15-2 Setting Up and Transmitting Data	54
15-2-1 Connecting the RS-232C cable	54
15-2-2 MOC-120H settings	54
15-2-3 Setting Up the Computer	54
15-2-4 Starting Up the Computer	56
15-3 Computer Output Format	57
16. Maintenance	59
16-1 Performing Maintenance	59
16-2 Replacing Fuses	60
17. Parts List	61

1. Introduction

Thank you for choosing the Shimadzu Electronic Moisture Balance MOC-120H. MOC-120H has high reliability by employing the UniBloc cell, introduced for use in electronic balances by Shimadzu in 1989. It provides WindowsDirect functions for transfer of measurement results to personal computer without installing software. This and other various functions can be used to meet the operator's objectives.

In order to make full use of the functions and performance provided in the MOC-120H, please read this instruction manual before using the balance and keep the manual for future reference.

For information on the following points, please contact your Shimadzu Balance representative.

- Product warranty
- After service

2. Description of Features and Principles of Operation

2-1 Principles of Operation

This unit determines the moisture and solid contents of samples by heating them using infrared illumination and measuring changes in mass due to evaporation. This is referred to as the drying loss method and is the simplest method for determining moisture content and thus mandated by many public regulations related to measurement standards.

2-2 Features

- **UniBloc sensor**

The core mechanism of the internal precision balance is the UniBloc*1 cell which provides excellent responsiveness, temperature characteristics, and shock resistance. This UniBloc*1 sensor ensures excellent reliability in moisture content measurements over a long period of use.

- **New Auto Taring Function**

The MOC-120H comes with an internal Auto Taring Function which makes it possible to perform reset correction while performing measurements, thus eliminating drift of the balance even when performing measurements over a long time and making it possible to obtain extremely reliable measurements.

- **Mid-infrared quartz heating lamp**

The MOC-120H uses a mid-infrared quartz heating lamp (with a central wavelength of 2.6 μm). This heater provides excellent drying efficiency over a wide range of different types of sample, minimizes the differences in heating due to the different colors of samples, and eliminates the overheating of sample surfaces, thus making it possible to obtain ideal drying conditions.

What's more, this heating lamp also provides a long service life 5 to 10 times greater (20,000 to 30,000 hours) than older infrared or halogen lamps.

- **A wide selection of measuring modes**

The MOC-120H provides a wide selection of measuring modes (automatic operation mode, timed operation mode, high-speed drying mode, low-speed drying mode, stepped drying mode, and predictive measuring mode) which makes it possible to perform measurements under the best drying condition for each sample.

- **The ability to store measuring conditions**

The MOC-120H provides 10 measuring conditions storage areas which may be used to store sets of measuring conditions to be used for different types of samples, thus reducing the work of programming settings before each measurement.

- **Data memory**

The MOC-120H is able to store up to 100 pieces of measurement data in memory, making it possible to output large batches of data all at one time.

- **Printer port**

The MOC-120H is equipped with a printer port which may be used to connect to the optional printer, thus making it possible to print out text or graph data showing final measurements or intermediate drying states while performing measurements.

- **The ability to display changes in moisture content (ΔM) in a numeric and bar graph display**

The change ΔM in moisture content over 30-second intervals is displayed in a numeric and bar graph display, thus making it easier to estimate when a measurement should be completed. This feature is also useful in helping to determine measurement completion conditions.

2-3 Applications (i.e., materials which can be measured)

- Materials for which water is the only or main component which evaporates as a result of heating
- Materials for which no dangerous chemical reactions or other changes occur as a result of heating

* **Measurements can be performed with virtually any material meeting these conditions.**

3. Specifications

Measurement format	: Evaporation weight loss method (Heat drying and weight loss method)
Sample weight	: 0.5g - 120g
Minimum display	: Moisture content: 0.01% Weight: 0.001 g
Measurable quantities	: Moisture content (wet base & dry base), weight, solid content
Reproducibility (Standard deviation)* ¹	: Samples with a weight of 5 g or higher less than 10g: 0.05% * ¹ Samples with a weight of 10 g or higher: 0.02% * ¹
Measurement modes	: Automatic operation mode Timed operation mode (with measurement times of 1~240 minutes or continuous measurement mode, with a maximum measurement time of 12 hours) High-speed drying mode (may be used with either automatic or timed operation mode) Low-speed drying mode (may be used with either automatic or timed operation mode) Stepped drying mode (performs drying in 5 steps) Predictive measuring mode
Heater temperature range	: May be set within a range of 30 to 200°C in 1°C increments (sample position temperature)
Display	: Backlit LCD display (137 x 43 mm)
External output	: RS-232C interface
Communications	: Allows for data output using WindowsDirect function
Storage of measurement conditions	: Allows for storage of 10 sets of measurement conditions
Data memory	: Allows for storage of 100 pieces of data
Temperature/humidity operating range	: 5~40°C, maximum of 85% RH
Heat source	: Medium frequency infrared quartz heater (maximum 625W)
Power supply	: AC 100~120/220~240V (50/60 Hz)
Voltage fluctuations	: Within ±10%
Interrupting rating of fuse	: 500A
Power consumption	: Maximum of 640W
Pollution Degree	: 2
Overvoltage Category	: Category II
Altitude	: Up to 2000 m
Installation Site	: device may only be used indoors
Weight and external dimensions	: 4.5 kg, 220 x 415 x 190 mm (W x D x H)
Sample pan	: SUS sample pan (Diameter: 130 mm; Depth 13 mm)
Items included	: 2 sample pans, 2 sample pan handler, wind shield, sample pan supporter, spoon, spatula, 2 spare 8A-fuses, 20 aluminum foil sheets, power cord, Instruction manual
Optional equipment	: Printer set (includes DPU-414 printer, printer interface cable printer paper 1roll, and AC adapter), printer paper (10 rolls), package of aluminum foil sheets (500 sheets), RS-232C cable, Temperature calibration kit

*¹ When using Shimadzu standard samples and measuring conditions. It is not applied to and not guaranteed with all samples or conditions.

4. Names of Individual Parts and Components

4-1 Names of Parts of Main Unit

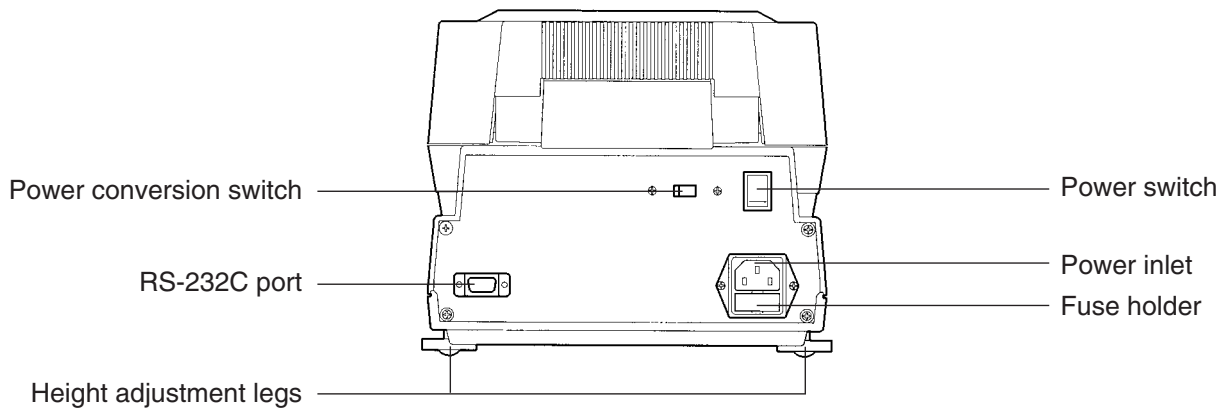
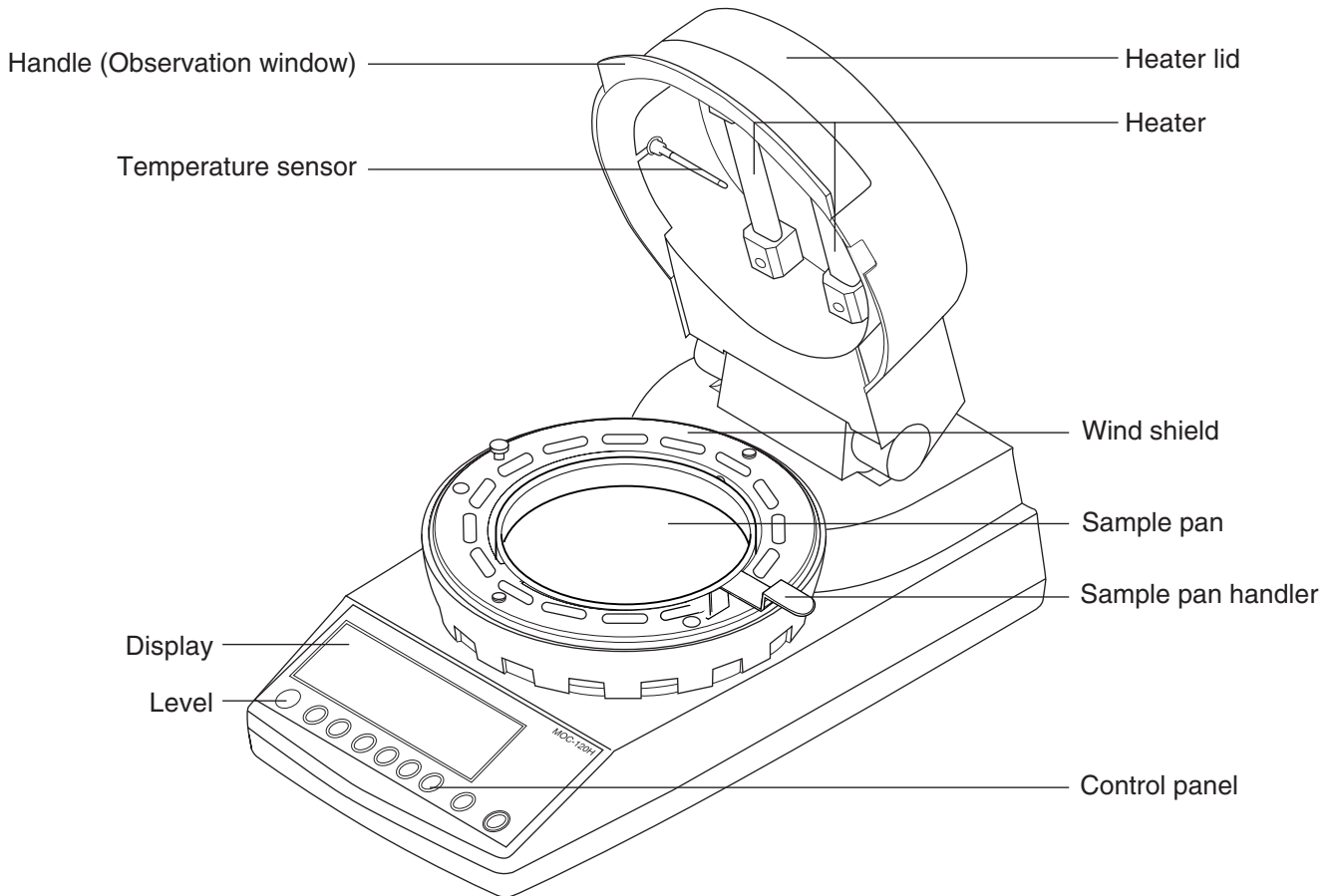

4-2 Parts and Accessories

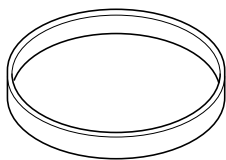

Sample pan (2)

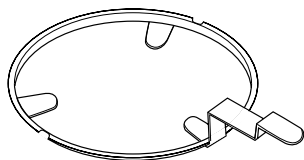

Sample pan handler (2)

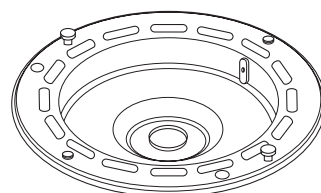

Wind shield

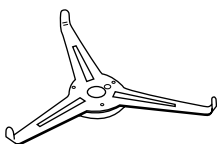

Sample pan supporter

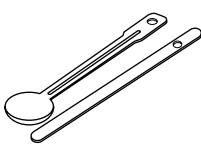

Spoon and spatula (1 each)

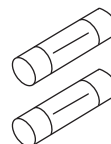

Spare 8A-fuses (2)

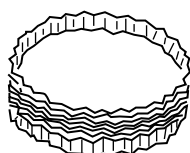

Aluminum foil sheets (20)

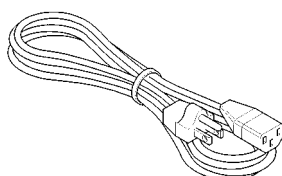

Power cord
(Depending on a destination, the connector shape of the cord is different from this figure or, cord in itself may not be attached.)

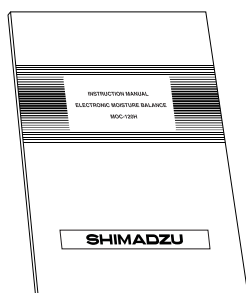

Instruction manual

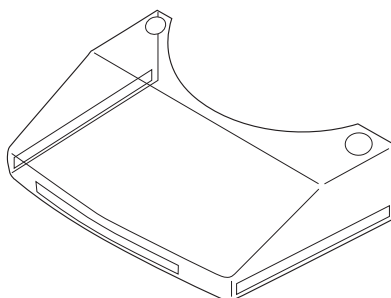

Protection Cover

5. Display and Control Panel

5-1 Display

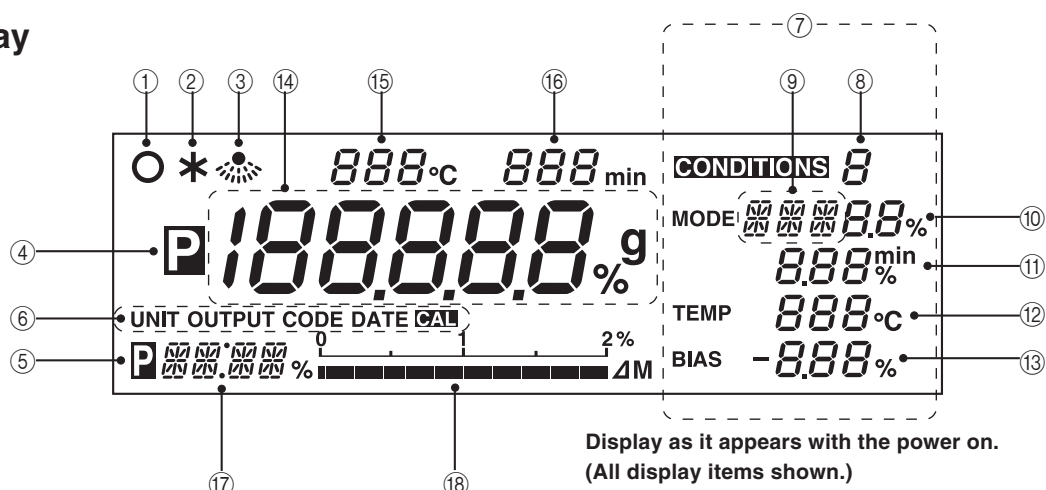









Item	Name	Description
①	Stability indicator	This indicator lights up when the balance is stable.
②	Measuring completion indicator	This indicator lights up when measuring has been completed.
③	Heater indicator	This indicator flashes whenever the heater is on.
④	Predictive measurement indicator	This indicator lights up when performing predictive measurements.
⑤	Preparatory measurement indicator	This indicator lights up when measuring has been completed after performing a preparatory measurement.
⑥	Menu display (during menu selection)	Displays individual menu items in sequence each time the SELECT key is pressed after pressing the MENU key.
⑦	Measuring conditions display (during condition setting)	Flashes to display individual items in sequence each time the SELECT key is pressed after pressing the CONDITION key. Values may be specified for a given item when it is flashing.
⑧	Measuring conditions storage display*	Displays the reference number of the currently selected measuring conditions program.
⑨	Measuring mode display*	Displays the currently selected measuring mode.
⑩	Predictive measurement convergence conditions display*	Displays the conditions for convergence of measured values when operating in predictive or comparative mode. When operating in high-speed drying mode, used to display the conditions required in order to maintain a temperature of 180°C.
⑪	End conditions display*	Displays the currently selected end conditions. When the value is displayed as a percentage, it indicates that measuring will end automatically, and when value is displayed in minutes, it indicates that measuring will end when the specified amount of time is reached.
⑫	Drying temperature display*	Displays the currently selected drying temperature.
⑬	Bias display*	Displays the moisture (or solid) bias.
⑭	Moisture/Solid/Weight display	When measuring weight (i.e., when in idling mode), used to display the weight in grams. When performing measurements, used to display the moisture content and solids content as percentages. When measuring weight, this display is also used to display 'oL' (overload) when the weight exceeds the maximum measurable weight and to display '-oL' (negative overload) when the weight does not reach the minimum measurable weight.
⑮	Temperature display	When 'TT' mode is selected, displays the temperature near the heater with °C symbol illuminated. When 'ST' mode is selected, displays the sample position temperature with °C symbol blinking. *Refer to 8.1 for the details of 'ST' and 'TT' modes.
⑯	Measuring time display	Displays the amount of elapsed time during measuring.
⑰	Change in moisture (solid) content display	Displays the change ΔM in moisture (or solid) content at 30-second intervals during measurement.
⑱	Change in moisture (solid) content scale display	Displays the change ΔM in moisture (or solid) content in scalar format. The scale may display a maximum change of 2 percent/30 seconds.

* Items marked with an asterisk display as flashing items during condition setting.

5-2 Control Panel Operations

The control panel keys are used to perform the following operations.



Name	Operation
 START/STOP START/STOP key	Used to start measuring or to abort a measuring operation. Also used to turn off the alarm which sounds to indicate that a measuring operation has been completed.
 TARE/RESET TARE/RESET key	Used to deduct the tare weight. Also used to perform a reset after an error has occurred. Also used to return to display of weight after completion of measurement.
 ENTER ENTER key	Used to confirm currently selected settings during menu selection. When further settings must be specified, pressing the ENTER key causes the next specifiable item choice to be displayed.
 SELECT SELECT key	Used to display the selectable items or for setting values during menu selection or condition setting.
 UP key / DOWN key	Used for numerical settings. Pressing the  key causes the value to increase, and pressing the  key causes the value to decrease.
 CONDITION CONDITION key	Used to enter and exit the measuring condition setting mode.
 MENU MENU key	Used to enter and exit the menu selection mode.

6. Assembly and Installation of Main Unit

① Opening the package

Open the package and check to make sure all listed items are included.

② Installing the main unit

Place the main unit on a flat, stable surface where it will not be subject to vibrations or exposed to drafts or breezes indoors.

③ Removing the protective sheet

When using the unit for the first time after purchase, remove the protective sheet attached to pan supporter column.

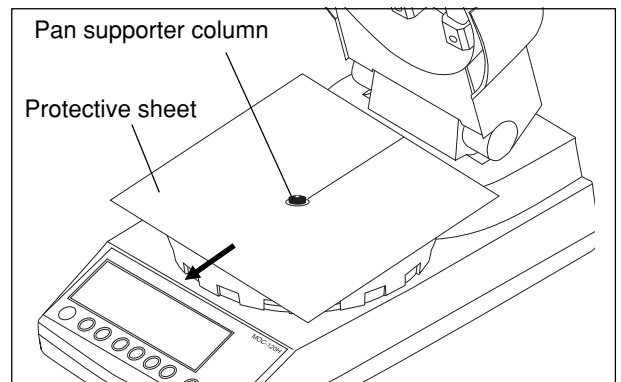

④ Ensuring that the unit is level

Turn the two height adjustment legs located at both sides of the lower rear of the unit to adjust until the level bubble falls within the red circle.

* The level is located to the left of the control panel. The instrument is level if the bubble appears in the center of the red circle when viewed from directly above.

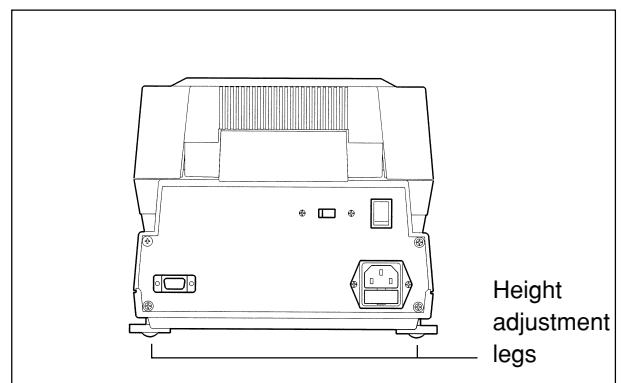
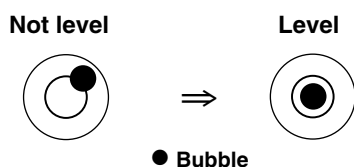

▲ Level is located to the left of the control panel.

⑤ **Installing the wind shield**

Open the lid of the heater, hold the wind shield by the knobs on the top, and place it on top of the pan supporter column so that the two round holes in the wind shield fit over the stays .

- * **Place the wind shield firmly into position so that it does not come into contact with the black pan supporter column located at the center of the weighing unit.**

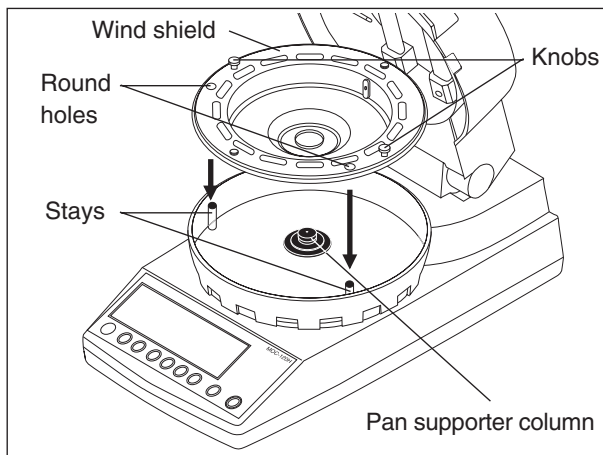

⑥ **Attaching the sample pan supporter**

Place the sample pan supporter gently into the pan supporter column at the center of the main unit. Make certain that the round hole of the sample pan supporter fits smoothly over the stay on pan supporter column.

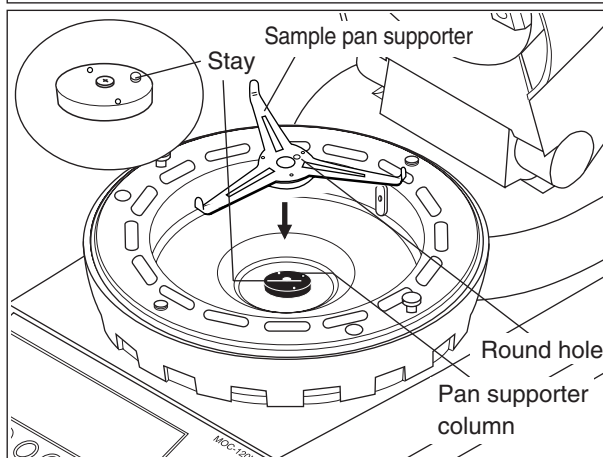

⑦ **Attaching the sample pan handler**

Next, attach the sample pan handler. Make certain that one of the grooves of the handler fit smoothly over the projection located at the rear of the wind shield.

- * **The handle may be placed either to the left or right, in the position you find easiest to use.**

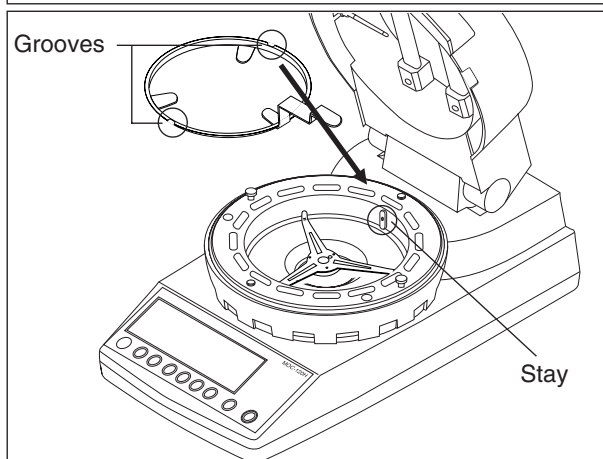

⑧ **Placing the sample pan**

Place the sample pan gently down onto sample pan supporter.

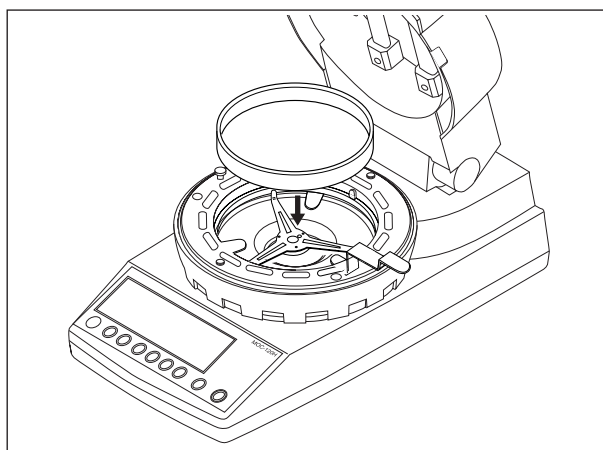

⑨ **Close the heater lid**

Set the Protection Cover on the display.
Adhesive tapes are attached to the Protection Cover.

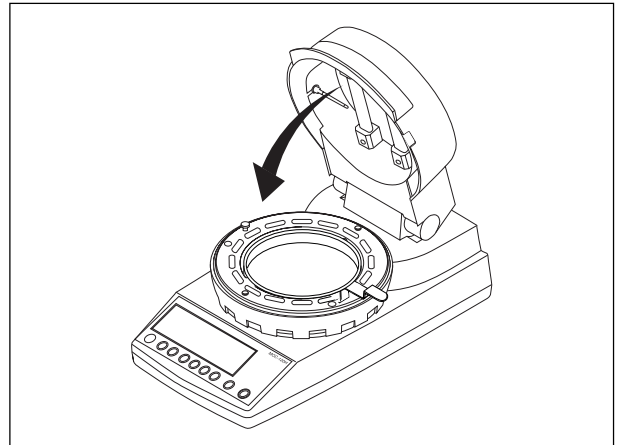

⑩ **Connecting the power cord**

Insert the female end of the power cord into the power inlet located at the rear of the unit. Then, attach the three-prong plug adapter to the power cord plug and insert the plug into power socket.

⑪ **Connecting the printer (optional)**

If you use the optional printer, connect the printer with the provided printer interface cable. For instructions on how to use the printer, see the separately provided DPU-414 Printer User's Manual.

* **Some parts must be oriented in a fixed direction for assembly. Note that placing parts in the wrong direction may prevent heater from closing or in erroneous readings being obtained, and that you should accordingly take care that all parts are put into place in their proper positions.**

⊘ **Ground the product**

- To prevent electric shock and to maintain stability in operation of the product, be sure to ground the product.

The product will be grounded when its power plug is inserted into a 3-wired power socket equipped with a ground terminal.

⑫ **Checking the power settings**

Check the power conversion switch located on the rear of the main unit to make sure that it is set to the proper voltage setting for your power source. If not, turn the switch to the correct position.

* **Note that an error will occur if this switch is not set to a position matching the power source being used.**

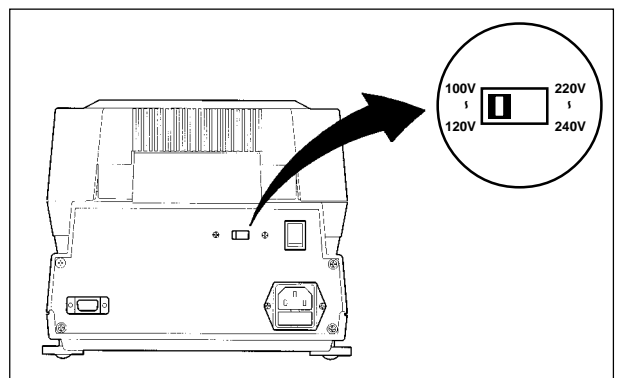









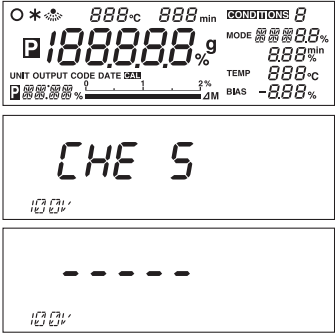

13 Specifying the power voltage setting

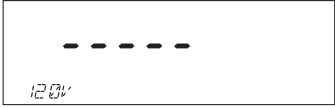
The specifiable voltages differ depending on the power setting with the power conversion switch described in 12.

⚠ Note: This setting must be done according to the power voltage available at the installation site.

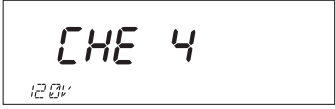
■ How to specify the power voltage setting









Step	Key(s) used	Display	Operating instructions
13-1	 Turn on power		Turn on the power while holding the  key pressed down. * Note that you should not remove your finger from the  key until a string of hyphens '-----' are displayed.
13-2			A tone will sound, the display will light up with all items lit and then change to display first 'CHE5' and then a string of hyphens (i.e., '- - - - -'). At the bottom left of the display will be displayed the currently specified power voltage.
13-3			If the power conversion switch is set to '100~120V', pressing the  key will cause the display to switch from 100V → 110V → 120V and back to 100V in sequence. If the power conversion switch is set to '220~240V', pressing the  key will cause the display to switch from 220V → 230V → 240V and back to 220V in sequence. Note that here a voltage of '120V' has been specified.
13-4			When the voltage at the installation site is displayed, press the  key. The display will then change from 'CHE4' to 'CHE0' in sequence with the specified voltage still displayed. : : :
13-5			A tone will then sound and the display will return to the regular weight display.



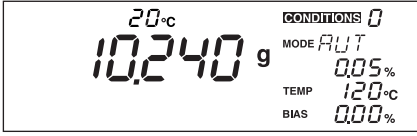

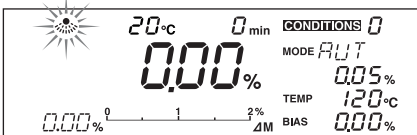

7. How to Conduct Measurements

Before beginning measurement, check to make sure that there is nothing remaining in the sample pan. Also be sure that all parts of the main unit are firmly fixed into place and be sure that the heater lid has been closed firmly before starting to perform measurements.

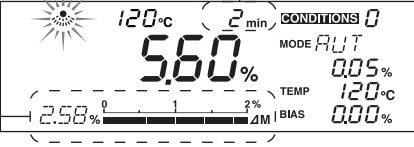
Also be sure to check on a regular basis that the main unit is level and readjust the height adjustment legs if necessary. (See “6. Assembly and Installation of Main Unit” on p. 8 for instructions on how to do so.)

Operating instructions	Display
<p>① Turn on the power switch</p> <p>* Once the power voltage setting has been specified (Step ⑩ in 6.), when the power is turned on for the second or subsequent times, a tone will sound, the display will light up with all items lit, the display will change to display ‘CHE4’, ‘CHE3’, ... , ‘CHE0’ while the currently specified power setting is displayed, and then a tone will sound again and the display will change to weight reading display mode.</p> <p>* Note: It is recommended that you always turn on about half an hour before use in order to obtain consistent measurements.</p>	<div style="border: 1px solid black; padding: 5px; margin-bottom: 10px; text-align: center;"> </div> <p>* Display will show default settings at the time of shipment. (See p. 17, “8-2-1 Selecting the CONDITIONS (Measuring conditions storage area)”.)</p>
<p>② Specifying settings</p> <p>When performing measurements for the first time or when you wish to change current settings before measuring, you should specify the settings required for measuring at this time. (See “8. Specifying Measuring Conditions” on p. 15 and “9. Menu settings” on p. 29 for instructions on how to do so.)</p>	
<p>③ Placing the sample pan in the tester</p> <p>Open the heater lid, place the sample pan on the handler, and place the handler into the tester, being sure when you do so that the grooves of the handler fit smoothly over the projection located at the rear of the wind shield.</p> <p>* If you have already place the sample pan and handler into place as described in “6. Assembly and Installation of Main Unit”, then proceed directly to the next step.</p> <p>* When using an aluminum foil sheet or other wrapping material because of the nature of the sample being measured, place it on top of the sample pan.</p>	

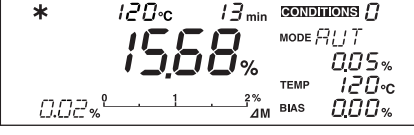
Operating instructions	Display
<p>④ Performing a reset</p> <p>Close the lid of the heater, check to make sure that the stability indicator (○) is being displayed, and then press the  key.</p> <p>When '-----' and 'TARE' appear on the display, the sample pan moves upward and downward. When a tone rings, then the reset is completed and the display returns to '0.000 g'.</p> <p>* Always be sure that the heater lid is closed when performing a reset. Also make sure that the tester is not exposed to drafts or breezes or subjected to any vibrations when a reset is being performed.</p>	
<p>⑤ Placing a sample in the tester</p> <p>Open the lid to the heater and place the sample inside.</p> <p>Be sure to place the sample as flat as possible into the tester so that heat is applied evenly to the sample during measurement. (See "11. Precaution on Conducting Measurements" for further information.)</p>	
<p>⑥ Beginning measurement</p> <p>Close the lid of the heater, check to make sure that the stability indicator (○) is being displayed, and then press the  key. The display will switch from a display of the weight (i.e., grams) to a percentage display and the measuring time will be displayed.</p> <p>The heating indicator (☀️) will start to flash and drying will begin.</p> <p>* There may be times when the stability indicator (○) is not displayed because of external vibrations or drafts or breezes. While it is possible to perform measurements at such times, there may be cases when it is impossible to obtain accurate measurements at such times, and you should accordingly always be sure to conduct measurements in a location as free as possible of vibrations, drafts, breezes, or any other harmful influences.</p> <p> </p> <p>* Do not open the lid to the heater during measurement.</p> <p>*  Note: During Measurement During measurement, the sample pan supporter moves upward and downward automatically once per minute (or once every 30 seconds when near the end of the measuring time) for automatic taring. The movement is indicated by servo motor noise.</p>	 

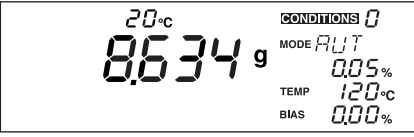
Operating instructions	Display
<p>⑦ Measuring time display</p> <p>While a measurement is being performed, the amount of time elapsed will be displayed in minutes.</p> <p>* The change in moisture content over each 30-second interval is displayed numerically and in scalar format (where the scalar display may display a maximum change of 2 percent/30 seconds).</p> <p>* Taring is performed automatically once per minute (or once every 30 seconds when near the end of the measuring time) while measuring moisture content.</p> <p>* To stop measuring when in the midst of a measuring operation, press the  key.</p>	
<p>⑧ Completion of measurement</p> <p>When the measuring operation has been completed, the heating indicator () will disappear, the measurement completed indicator (*) will be displayed, and a tone will ring for a period of 10 seconds. To turn off the tone earlier, press the  key.</p> <p>The results of the measurement will be displayed and remain on the display. Pressing the  key at this point causes Signature title to be printed. (See 14-1 Printer Output Sample)</p>	
<p>⑨ Resetting the display</p> <p>Pressing the  key at this point causes the display of the results of the measurement (i.e., moisture content) to disappear and be replaced by a display of the weight of the sample after drying.</p> <p>* Note that a reset cannot be performed until the completion tone has stopped ringing.</p>	
<p>⑩ Disposing of samples after measurement</p> <p>Open the lid to the heater, raise the sample pan handler vertically from the unit, remove the sample pan, and dispose of the sample.</p> <p>* Note that the sample and sample pan may be very hot and you should accordingly be careful in handling them at this time.</p>	
<p>⑪ Getting ready to perform the next measurement</p> <p>Leave the lid to the heater open to allow the tester to cool off. When performing measurements one after the other, leave an interval of about 1-2 minutes between each measurement and make sure that the tester has cooled down before proceeding to the next measurement. You should also keep a spare (cooled) sample pan on hand to use in the next measurement. (See “11. Precaution on Conducting Measurements” on p. 40 for further information.)</p> <p>When ready, return to step ③ and begin the next measurement.</p>	
<p>⑫ Turning off the power</p> <p>When all measurements have been completed, turn the power switch to the off position. Also be sure to turn the power off whenever the tester is not in use.</p>	

8. Specifying Measuring Conditions

When using this tester to measure moisture or solid content, it is necessary to first specify the conditions (e.g., drying temperature or measuring mode) of the measurement. The settings to be specified are described below.

It is also possible to save sets of measuring conditions (i.e., drying temperature, measuring mode, and bias).

8-1 Selecting Temperature Display Mode

The temperature display that is used for drying temperature setting and temperature indication on the main unit display can be selected from the following two modes.

[ST (Sample position Temperature)] mode

The temperature at the sample position is used for setting and displaying temperatures.

Sample position temperature is converted from the temperature detected by the thermistor near the heater. The default setting is this mode.

TT (Thermistor Temperature) mode

The temperature detected by the thermistor near the heater is used for setting and displaying temperatures.

■ How to select temperature display mode

Step	Key(s) used	Display	Operating instructions
①	SELECT CONDITION		From the weight display, press SELECT key first and while holding it down, press CONDITION key and keep pressing both keys for about 5 seconds.
②			Currently selected temperature display mode is indicated as either 'TT' or 'ST' at the M display part.
③			Every time SELECT key is pressed, the display is switched between 'TT' and 'ST'. Press ENTER key while the desired temperature display mode is shown.
④	SELECT ENTER		It returns to the weight display upon completion of setting temperature display mode.

The temperature display mode selected here is effective for all measurement modes.

Indication of currently set mode:





In the display, the °C symbol **blinks** when the current setting is 'ST' mode and when the current setting is 'TT' mode, the °C symbol is illuminated without blinking.

8-2 Types of Settings

Setting	Display during specification of setting	Description
CONDITION	CONDITION 0~9 (Measuring conditions storage areas 0~9)	Used to select the area to store condition settings. There are 10 storage areas labeled from 0 to 9. (See “8-3-1 Selecting the CONDITIONS (Measuring conditions storage area)”.)
MODE (Measuring mode)	AUT (AUTO: Standard drying & Automatic ending mode)	In automatic operation mode, measuring is brought to a end whenever the change in moisture content over two consecutive 30-second periods falls below the specified conditions for automatic ending. (For further information, see 8-3-2 “1) Specifying settings for AUTO (Automatic ending) mode”.)
	TIM (TIME: Standard drying & Timed ending mode)	In timed operation mode, measuring is ended when the elapsed time reaches the specified measuring time. (For further information, see 8-3-2 “2) Specifying settings for TIME (Timed operation) mode”.)
	RPD (RAPID: High-speed drying mode)	In high-speed drying mode, the sample is dried at a temperature of 180°C until the amount of change in moisture content over a 30-second interval falls below a specified value and then drying is continued at a specified drying temperature. (For further information, see 8-3-2 “3) Specifying settings for RAPID (High-speed drying) mode”.)
	SLW (SLOW: Low-speed drying mode)	In low-speed drying mode, the temperature is raised more gradually than when performing measurements under normal conditions, taking about 5 minutes from the time when measuring begins until the temperature reaches the specified drying temperature. (For further information, see 8-3-2 “4) Specifying settings for SLOW (Low-speed drying) mode”.)
	STP (STEP: Stepped drying mode)	In stepped drying mode it is possible to specify a separate drying temperature and separate measuring time over up to 5 step intervals. (For further information, see 8-3-2 “5) Specifying settings for STEP (Stepped drying) mode”.)
	CMP (COMPARE: Preparatory measuring mode for Predictive mode)	Preparatory measuring mode is used for determining the bias (i.e., the difference between the measurement corresponding to that obtained in automatic operation mode and the predicted measurement value) needed in order to perform measurements in predictive measuring mode. (For further information, see 8-3-2 “6) Specifying settings for COMPARE (Preparatory measuring) mode”.)
	PRD (PREDICT: Predictive measuring mode)	In predictive measuring mode, the intermediate results of drying are used to predict future changes and to calculate the result and thereby shorten the measurement time. (For further information, see 8-3-2 “7) Specifying settings for PREDICT (Predictive measuring) mode”.)
TEMP (Drying temperature)	000	This parameter may be used to specify the drying temperature. The temperature may be set anywhere within a range of from 30°C to 200°C in 1-degree increments. (30°C to 180°C in ‘TT’ mode) (For further information, refer to 8-1 Selecting Temperature Display Mode, 13. Temperature Calibration and “8-3-3 TEMP (Drying temperature)”.)
BIAS	0.00	This parameter is used to specify a numeric value to be used to correct measurements for bias. A bias anywhere in the range of from -9.99% to 9.99% may be specified in 0.01% increments. (For further information, see “8.3.4 Bias”.)

8-3 Descriptions of Individual Measuring Condition Settings

For a detailed description of individual measuring condition settings, see the instructions in subsection 8-2-1 and subsequent subsections.

- ① To start specifying measuring condition settings:
Press the  key at a time when the display shows a weight reading.
- ② If any password other than the default password of ‘0000’ has been specified, then a ‘PASS’ message will be displayed in the weight display area. When this message is displayed, follow the instructions in “9.2.7 Specifying a password”, to enter the password. If the password entered is incorrect, the display will return to the weight display.
- ③ Selecting individual measuring conditions:
First a ‘**CONDITIONS**’ message will flash on the display. Pressing the  key at this time causes the flashing item to change in sequence from **MODE** → **TEMP** → **BIAS** → **CONDITIONS** and back to **MODE** each time the key is pressed. When the item you wish to specify is flashing, press the  key. Specify the settings for that item.
- ④ To finish specifying measuring condition settings:
Pressing the  key when any settings item is flashing causes the settings specified to take effect and causes the display to return to the normal weight display.











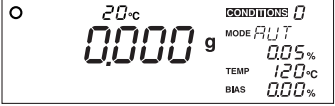

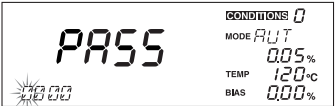



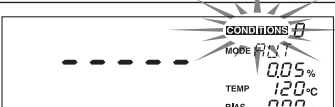





8-3-1 Selecting the CONDITIONS (Measuring conditions storage area)

Below is described the procedure used to select the area in which measuring conditions are saved. This operation causes the measuring mode, drying temperature, bias, and other currently specified measuring conditions to be saved to the selected area.

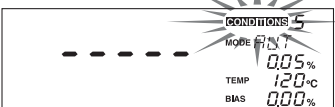
* At the time of shipment, the following settings are stored in measuring conditions storage areas 0~9:

- Measurement standard : Wet Base
- Drying temperature : 120°C
- Measuring mode : Standard drying & Automatic ending mode (Change in water content of 0.05% over 30seconds)

■ Specifying settings for the CONDITIONS (Measuring conditions storage area)

Step	Key(s) used	Display	Operating instructions
①			With the display of the weight in grams, press the  key.
②			If a password has been specified, the message 'PASS' will be displayed to indicate that the password should be entered. Use the  key,  key and  key to enter the password. Follow the instructions under step ⑦ in "9-2-7 Specifying a password" to set or delete a password.
③			The 'CONDITIONS' display area will begin to flash.
④			Press the  key. This will cause control to move to the measuring conditions area number and the number will flash.
⑤	 		Press the  key or  key to select a measuring conditions area number from 0 to 9. In this example, area number '5' is selected.
⑥			When the desired measuring conditions area number starts flashing, press the  key. The selected measuring conditions area number will change from a flashing to a constantly lit display and the 'CONDITIONS' message will begin to flash instead.
⑦	 		If you wish to specify other measuring conditions settings, press the  key to select the menu. To exit from specifying measuring conditions settings, press the  key instead.

8-3-2 Selecting the MODE (Measuring mode)

The 'MODE' (measuring mode) setting is used to specify the conditions under which measuring is to be completed. As shown in the table in subsection "8.1 Types of Settings", the mode may be set to automatic operation mode, timed operation mode, or any one of five other modes.

1) Specifying settings for AUTO (Standard drying Automatic ending) mode

In this mode, measuring is brought to a end whenever the change in moisture content over two consecutive 30-second periods (i.e., over a period of 1 minute) falls below the specified conditions for automatic ending. Automatic ending conditions may be specified in 0.01-percent increments anywhere in a range from 0.01 to 0.1 percent. Specifying a smaller percentage causes measurements to closely approach a point of equilibrium, but more time is required for measurement. Specifying a higher percentage lessens the amount of time required for measurement, but measuring is stopped while there is still a wide variation in measurements. The automatic ending conditions should be specified in accordance with your objectives and the type of sample being measured.

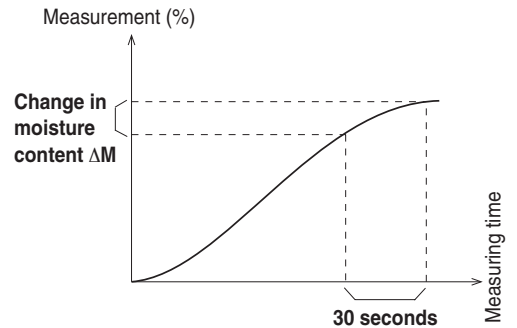

















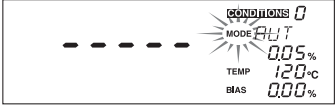

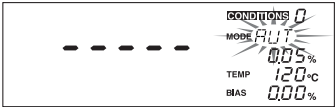

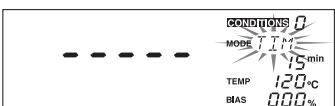





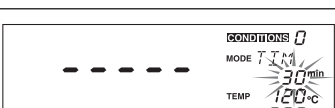

Step	Key(s) used	Display	Operating instructions
①	CONDITION		With the display of the weight in grams, press the CONDITION key.
②			If a password has been specified, the message 'PASS' will be displayed to indicate that the password should be entered. Use the ▲ key, ▼ key and ENTER key to enter the password. Follow the instructions under step ⑦ in "9-2-7 Specifying a password" to set or delete a password.
③	SELECT		The ' CONDITIONS ' display area will begin to flash. Press the SELECT key until ' MODE ' begins to flash.
④	ENTER		With the ' MODE ' display flashing, press the ENTER key. This will cause control to shift to measuring mode selection and for the currently specified measuring mode to begin flashing.
⑤	SELECT		Press the SELECT key repeatedly until 'AUT' begins to flash. * Since 'AUT' will already be flashing at the point, proceed directly to the next step.
⑥	ENTER		When 'AUT' begins to flash, press the ENTER key. This will cause the automatic end conditions (i.e., amount of change in moisture content per 30 seconds) setting to become active and it begins flashing.
⑦	▲ ▼		Press the ▲ key or ▼ key to select the automatic end conditions. Note that here we specify a setting of 0.10 percent.
⑧	ENTER		When the desired automatic end conditions setting flashes, press the ENTER key. The automatic end conditions setting will change from a flashing to a constantly lit display and ' MODE ' will begin to flash again.
⑨	SELECT CONDITION		If you wish to specify other measuring conditions settings, press the SELECT key to select the setting to be specified. To exit from specifying measuring conditions settings, press the CONDITION key instead.

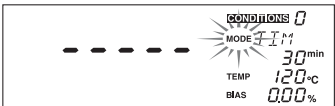
2) Specifying settings for TIME (Standard drying & Timed ending) mode

In this mode, the measuring time is specified beforehand. When the specified measuring time is reached, measuring is ended.

Measuring time may be specified in 1-minute increments anywhere in a range from 1 to 240 minutes or measuring may be specified to be performed over a continuous period of 12 hours.

Step	Key(s) used	Display	Operating instructions
①			With the display of the weight in grams, press the  key.
②			If a password has been specified, the message 'PASS' will be displayed to indicate that the password should be entered. Use the  key,  key and  key to enter the password. Follow the instructions under step ⑦ in "9-2-7 Specifying a password" to set or delete a password.
③			The 'CONDITIONS' display area will begin to flash. Press the  key until 'MODE' begins to flash.
④			With the 'MODE' display flashing, press the  key. This will cause control to shift to measuring mode selection and for the currently specified measuring mode to begin flashing.
⑤			Press the  key repeatedly until 'TIM' begins to flash. * If 'TIM' is already flashing, then proceed directly on to the next step.
⑥			When 'TIM' flashes, press the  key. This will cause the measuring time settings to become active and the currently specified measuring time to flash.
⑦	 		Press the  key or  key to select the desired measuring time. Note that here a time of '30 minutes' is specified.
⑧			When the desired measuring time flashes, press the  key. The specified measuring time will change from a flashing to a constantly lit display and 'MODE' will begin to flash instead.
⑨	 		If you wish to specify other measuring conditions settings, press the  key to select the menu. To exit from specifying measuring conditions settings, press the  key instead.

3) Specifying settings for RAPID (High-speed drying) mode











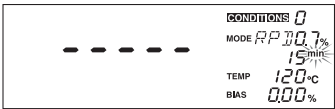

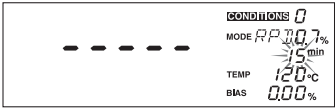



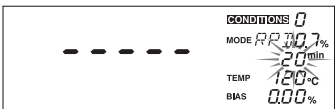

High-speed drying mode is useful for measuring samples with high levels of moisture content. In high-speed drying mode, the sample is dried at 180°C until the change ΔM in moisture content over a 30-second period becomes lower than setting, then drying will be continued at the specified drying temperature. The RAPID ΔM threshold specifies when high speed drying (180°C) will end. The threshold of RAIPID ΔM may be specified in 0.1-percent increments anywhere in a range from 0.1 to 9.9 percent.

* The actual time may vary depending on the specified temperature, but it generally takes about 2 minutes for the temperature control to automatically shift from 180°C to the specified temperature.

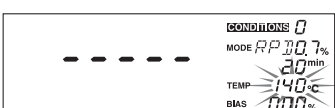
While specifying a lower RAPID ΔM threshold lessens the amount of time required for measurement, depending on the sample it may become burned making it impossible to obtain an accurate measurement. Specifying a higher threshold shortens the time over which a temperature of 180°C is maintained and reduces the effects of rapid drying.

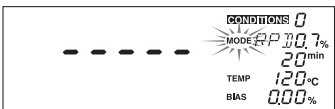
Either 'AUTO' (automatic ending) or 'TIME' (timed ending) may be specified to define the conditions under which measuring is to be ended.

Step	Key(s) used	Display	Operating instructions
①			With the display of the weight in grams, press the key.
②			If a password has been specified, the message 'PASS' will be displayed to indicate that the password should be entered. Use the , key and key to enter the password. Follow the instructions under step ⑦ in "9-2-7 Specifying a password" to set or delete a password.
③			The 'CONDITIONS' display area will begin to flash. Press the key until 'MODE' begins to flash.
④			With the 'MODE' display flashing, press the key. This will cause control to shift to measuring mode selection and for the currently specified measuring mode to begin flashing.
⑤			Press the key repeatedly until 'RPD' begins to flash. * If 'RPD' is already flashing, then proceed directly on to the next step.
⑥			When 'RPD' flashes, press the key. This will cause the numeric field next to 'RPD' begin to flash.
⑦	 		Press the key or key to select the desired RAPID ΔM threshold value. Note that here a value of '0.7%' is specified.
⑧			When the desired threshold begins to flash, press the key. The threshold will then be set and control will shift to the selection of the ending conditions. The units area for timed ending mode ('min') or automatic ending mode ('%') will begin to flash.

Step	Key(s) used	Display	Operating instructions
⑨	SELECT		Pressing the  key will cause the units to switch between minutes ('min') and a percentage ('%'). Press the  key until the desired units are displayed.
⑩	ENTER		When the desired unit flashes, press the  key. This will cause control to shift to the specification of the ending conditions and the numerical field begins to flash.
⑪	 		Press the  key or  key to set the value of the desired ending condition. Note that here the timed ending of 20 minutes has been specified.
⑫	ENTER		When the desired ending condition flashes, press the  key. The rapid drying temperature that was previously specified will begin to flash. (Default setting is 180°C for 'TT' mode, 200°C for 'ST' mode.)
⑬	 		Press the  key or  key to set the desired rapid drying temperature. Note that here a temperature of 140°C is set.
⑭	ENTER		When the desired temperature flashes, press the  key. The specified ending conditions will then change from flashing to a constantly lit display and 'MODE' will begin to flash.
⑮	SELECT CONDITION		If you wish to specify other measuring conditions settings, press the  key to select the menu. To exit from specifying measuring conditions settings, press the  key instead.

4) Specifying settings for SLOW (Low-speed drying) mode

In low-speed drying mode, the temperature is raised more gradually than when performing measurements under standard drying conditions, taking about 5 minutes until the temperature reaches the specified drying temperature.

Either 'AUTO' (automatic ending mode) or 'TIME' (timed ending mode) may be specified to define the condition under which measuring is to be ended.













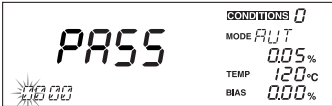



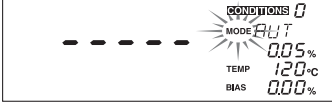

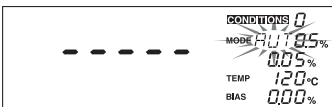

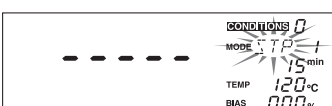

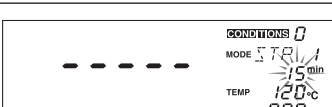



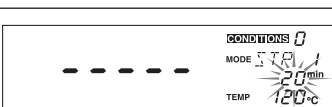

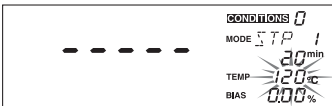

Step	Key(s) used	Display	Operating instructions
①			With the display of the weight in grams, press the key.
②			If a password has been specified, the message 'PASS' will be displayed to indicate that the password should be entered. Use the , key and key to enter the password. Follow the instructions under step ⑦ in "9-2-7 Specifying a password" to set or delete a password.
③			The 'CONDITIONS' display area will begin to flash. Press the key repeatedly until 'MODE' begins to flash.
④			With the 'MODE' display flashing, press the key. This will cause control to shift to measuring mode selection and the currently specified mode to begin flashing.
⑤			Press the key repeatedly until 'SLW' begins to flash. * If 'SLW' is already flashing, then proceed directly on to the next step.
⑥			When 'SLW' flashes, press the key. Control will then shift to specification of low-speed drying mode settings where the ending condition must be specified. The units area for timed ending mode ('min') or automatic ending mode ('%') will begin to flash.
⑦			Pressing the key will cause the units to switch between minutes ('min') and percentage ('%'). Press the key repeatedly until the desired unit is displayed.
⑧			When the desired unit for the ending condition begins to flash, press the key. This will cause control to shift to the specification of the ending condition and the numerical field begins to flash.
⑨	 		Press the key or key to set the desired ending condition. Note that here a time of 20 minutes has been specified.
⑩			When the desired time or percentage flashes, press the key. The specified ending condition will then change from flashing to a constantly lit display and 'MODE' will begin to flash.
⑪	 		If you wish to specify other measuring conditions settings, press the key to select the menu. To exit from specifying measuring conditions settings, press the key instead.

5) Specifying settings for STEP (Stepped drying) mode

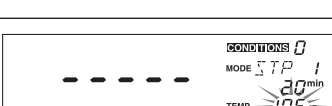
In stepped drying mode it is possible to specify separate drying conditions for up to a maximum of 5 steps. Specifying a separate drying temperature and measuring time for each step makes it possible to determine the optimum drying conditions for any sample type.

In Step 1, timed ending mode must be specified as the ending condition. In Step 2 and subsequent steps, it is possible to select between either automatic ending mode or timed ending mode.

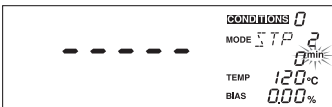
- * If automatic ending mode is selected in Step 2 or later, that step becomes the final step. When timed ending mode is selected and a value of '0' is specified as the measuring time, the previous timed ending step becomes the final step.

Step	Key(s) used	Display	Operating instructions
①			With the display of the weight in grams, press the  key.
②			If a password has been specified, the message 'PASS' will be displayed to indicate that the password should be entered. Use the  key,  key and  key to enter the password. Follow the instructions under step ⑦ in "9-2-7 Specifying a password" to set or delete a password.
③			The 'CONDITIONS' display area will begin to flash. Press the  key repeatedly until 'MODE' begins to flash.
④			With the 'MODE' display flashing, press the  key. This will cause control to shift to measuring mode selection and for the currently specified measuring mode to begin flashing.
⑤			Press the  key repeatedly until 'STP' begins to flash. * If 'STP' is already flashing, then proceed directly on to the next step.
⑥			When 'STP' flashes, press the  key. This will cause 'STP' to change from a flashing to a constantly lit display. Control will shift to the specification of the measuring time for Step 1, and the measuring time will flash.
⑦	 		Press the  key or  key to select the desired measuring time. The measuring time may be specified in 1-minute increments in a range anywhere from 1 to 240 minutes. Note that here a time of 20 minutes has been specified for Step 1.
⑧			When the desired measuring time flashes, press the  key. The measuring time will change from a flashing to a constantly lit display, control will shift to the specification of the drying temperature, and the drying temperature will begin to flash.
⑨	 		Press the  key or  key to select the desired drying temperature. The drying temperature may be specified in 1-degree increments in a range from 30°C to 200°C (30°C to 180°C in 'TT' mode). Note that here a temperature of 105°C has been specified for Step 1.
⑩			When the desired drying temperature flashes, press the  key. The step displayed will change from 'STP 1' to 'STP 2' and the units area for timed ending mode ('min') or automatic ending mode ('%') will begin to flash.

Step	Key(s) used	Display	Operating instructions
⑪	SELECT		Pressing the SELECT key will cause the units to switch between minutes ('min') and a percentage ('%'). Press the SELECT key until the desired unit is displayed.
⑫	ENTER		When the desired unit for the ending condition begins to flash, press the ENTER key. This will cause control to shift to the specification of the ending condition of Step 2 and the numerical field will flash. * Note that this step becomes the final step if automatic ending mode (i.e., a percentage) is specified here.
⑬	▲ ▼		Press the ▲ key or ▼ key to select the desired ending conditions. Note that here the timed ending at 20 minutes has been specified. (Also note that if automatic ending mode has been selected, a value from 0.01 to 0.1 percent may be specified in 0.01-percent increments. * Note that the previous step becomes the final step if timed ending mode is selected and a measuring time of '0' is specified here. * Note that continuous drying (i.e., a drying time of 12 hours) cannot be specified in this mode. The maximum drying time for each step is 240 minutes.
⑭	ENTER		When the desired ending condition begins to flash, press the ENTER key. This will cause the display of the ending condition to change from a flashing to a constantly lit display, for control to shift to the specification of the drying temperature for Step 2, and the drying temperature will begin to flash.
⑮	▲ ▼		Press the ▲ key or ▼ key to select the desired drying temperature. Note that here a temperature of 100°C has been specified.
⑯	ENTER		When the desired drying temperature is displayed, press the ENTER key. The step displayed will change from 'STP 2' to 'STP 3' and control will shift to the specification of ending condition. Go back to step ⑪ and repeat all subsequent steps up to this step until settings have been specified for all the drying steps. : : :
⑰	ENTER		When the settings for the final drying step have been specified, 'MODE' will begin to flash.
⑱	SELECT CONDITION		If you wish to specify other measuring conditions settings, press the SELECT key to select the menu. To exit from specifying measuring conditions settings, press the CONDITION key instead.

! Note: Read Section 12 before use of this part.

6) Specifying settings for COMPARE (Preparatory measuring) mode

Preparatory measuring mode is used to calculate the bias (i.e., the difference between the measurement results which would be obtained in Standard drying & Automatic ending mode and predictive measuring mode) needed for predictive measurements.

Prior to predictive measurements, this mode should be used first to seek the bias. (For further information, see “● Preparatory measuring mode” and “● Predictive measuring mode”.)

Step	Key(s) used	Display	Operating instructions
①	CONDITION		With the display of the weight in grams, press the CONDITION key.
②			If a password has been specified, the message ‘PASS’ will be displayed to indicate that the password should be entered. Use the ▲ key, ▼ key and ENTER key to enter the password. Follow the instructions under step ⑦ in “9-2-7 Specifying a password” to set or delete a password.
③	SELECT		The ‘ CONDITIONS ’ display area will begin to flash. Press the SELECT key repeatedly until ‘ MODE ’ begins to flash.
④	ENTER		With the ‘ MODE ’ display flashing, press the ENTER key. This will cause control to shift to measuring mode selection and for the currently specified measuring mode to begin flashing.
⑤	SELECT		Press the SELECT key repeatedly until ‘ CMP ’ begins to flash. * If ‘CMP’ is already flashing, then proceed directly on to the next step.
⑥	ENTER		When ‘ CMP ’ flashes, press the ENTER key. ‘ CMP ’ will change from a flashing to a constantly lit display and you will next be required to specify the predicted value convergence range settings (see “● Predicted value convergence range”(section 12)). The current setting for the predicted value convergence range will begin to flash.
⑦	▲ ▼		Press the ▲ key or ▼ key to specify the desired value. Any value of 0.1 to 9.9 percent in increments of 0.1 percent may be specified. Note that here a value of 0.5% has been selected.
⑧	ENTER		When the desired value is displayed, press the ENTER key. The display of the predicted value convergence range will change from a flashing to a constantly lit display, and control will shift to the automatic ending settings, and the setting specifying the degree of change in moisture content over a 30-second period will begin to flash.
⑨	▲ ▼		Press the ▲ key or ▼ key to select the desired automatic ending condition. Automatic ending condition may be specified in 0.01-percent increments anywhere in a range from 0.01 to 0.1 percent. Note that here a value of 0.05% has been selected.
⑩	ENTER		When the desired automatic ending condition has been selected, press the ENTER key. The specified setting will change from a flashing to a constantly lit display, and ‘ MODE ’ will begin to flash.
⑪	SELECT CONDITION		If you wish to specify other measuring conditions settings, press the SELECT key to select the menu. To exit from specifying measuring conditions settings, press the CONDITION key instead.

⚠ Note: Read Section 12 before use of this part.

7) Specifying settings for PREDICT (Predictive measuring) mode

Predictive measuring mode is used to predict the change in moisture content and calculate the predicted final measurement before drying has been completed. Thus measuring time can be saved. Note that some materials have properties which make it difficult to obtain accurate predictions. Measurements in preparatory measuring mode must be performed to check the precision of measurement and determine the possible effectiveness of Predictive Measurement in terms of shortening the measuring time.

Step	Key(s) used	Display	Operating instructions
①			With the display of the weight in grams, press the key.
②			If a password has been specified, the message 'PASS' will be displayed to indicate that the password should be entered. Use the key, key and key to enter the password. Follow the instructions under step ⑦ in "9-2-7 Specifying a password" to set or delete a password.
③			The 'CONDITIONS' display area will begin to flash. Press the key repeatedly until 'MODE' begins to flash.
④			With the 'MODE' display flashing, press the key. This will cause control to shift to measuring mode selection and for the currently specified measuring mode to begin flashing.
⑤			Press the key repeatedly until 'PRD' begins to flash. * If 'PRD' is already flashing, then proceed directly on to the next step.
⑥			When 'PRD' flashes, press the key. 'PRD' will then change from a flashing to a constantly lit display and you will next be required to specify the predicted value convergence range settings (see "● Predicted value convergence range"). The current setting for the predicted value convergence range will begin to flash.
⑦	 		Press the key or key to select the desired automatic ending condition. Automatic ending condition may be specified in 0.01-percent increments anywhere in a range from 0.1 to 9.9 percent. Note that here a value of 0.5% has been selected.
⑧			When the desired automatic ending condition has been selected, press the key. The specified setting will change from a flashing to a constantly lit display, and 'MODE' will begin to flash.
⑨	 		If you wish to specify other measuring conditions settings, press the key to select the menu. To exit from specifying measuring conditions settings, press the key instead.

8-3-3 TEMP (Drying temperature) Setting













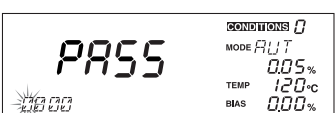



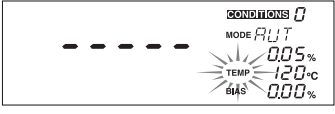

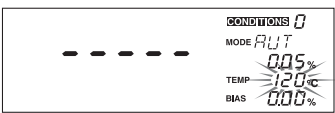

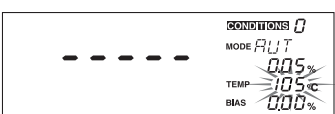

The following describes the procedure to specify the drying temperature in conducting measurements.

While the default drying temperature is 120°C, depending on the type of sample, its moisture content, or other conditions the proper drying temperature may vary. To find the proper drying temperatures for different types of materials, conduct repeated measurements until you find the correct temperature to use for each material.

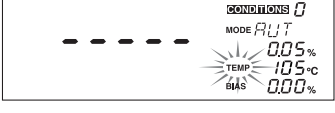
The drying temperature may be set within the range from 30°C to 200°C (from 30°C to 180°C in 'TT' mode) in 1-degree increments.

- * **Note that the drying temperature refers not to the temperature of the sample but the temperature of the temperature sensor. The actual temperature of samples during drying may vary depending on the color of the sample, its moisture content, or the type or form of the sample.**
- * **Generally speaking, drying is performed more quickly when a higher drying temperature is specified, but if the temperature specified is too high it might result in the sample becoming burned, thus making it impossible to obtain accurate measurements.**

■ Specifying settings for the TEMP (Drying temperature)

Step	Key(s) used	Display	Operating instructions
①			With the display of the weight in grams, press the  key.
②			If a password has been specified, the message 'PASS' will be displayed to indicate that the password should be entered. Use the  ,  key and  key to enter the password. Follow the instructions under step ⑦ in "9-2-7 Specifying a password" to set or delete a password.
③			The 'CONDITIONS' display area will begin to flash. Press the  key until 'TEMP' begins to flash
④			With the 'TEMP' indicator flashing, press the  key. This will cause control to shift to specification of the drying temperature and the currently specified drying temperature to begin to flash.
⑤	 		Press the  key or  key to select the desired drying temperature. Note that here a temperature of 105°C has been specified.
⑥			When the desired drying temperature flashes, press the  key. The display of the specified temperature will change from a flashing to a constantly lit display and the 'TEMP' indicator will begin to flash instead.
⑦	 		If you wish to specify other measuring conditions settings, press the  key to select the menu. To exit from specifying measuring conditions settings, press the  key instead.

8-3-4 Bias Setting

When necessary, measurements can be corrected with bias. A bias anywhere in the range of from -9.99% to 9.99% may be specified in 0.01% increments. A bias should be specified in cases such as below described.

- There are cases where measurement results with the MOC-120H fail to meet with expected (standard) values as moisture measurements are the result of various conditions. The bias may be set to adjust the measured value by the MOC-120H to the expected (standard) value. Thus, the measured value using the MOC-120H can be treated to be equivalent to the existing (standard) measuring method.
 - In most cases it is possible to match the expected (standard) values by optimizing the measuring conditions, but when such conditions would cause the sample to be burned, cause the time required too long, or result in other problems, a bias should be specified.
- When using more than one moisture balance unit, there may be cases where it is impossible to obtain identical measurements even when the same measuring conditions are used because of small differences in the surrounding environment. In such cases, set the bias of the unit that is to serve as the standard to zero and set the bias of the other units set to account for any such differences.
 - For information on how to specify the bias when operating in predictive measurement mode, see, “12-2-1 Calculating the bias to be specified when operating in predictive measurement mode”.

■ How to set the bias

Step	Key(s) used	Display	Operating instructions
①			With the display of the weight in grams, press the key.
②			If a password has been specified, the message 'PASS' will be displayed to indicate that the password should be entered. Use the , key and key to enter the password. Follow the instructions under step ⑦ in “9-2-7 Specifying a password” to set or delete a password.
③			The 'CONDITIONS' display area will begin to flash. Press the key repeatedly until 'BIAS' begins to flash.
④			With the 'BIAS' indicator flashing, press the key. Control will then shift to the bias specification, and the currently specified bias value will begin to flash.
⑤	 		Press the key or key to select the desired bias. Note that here a bias of 0.2% has been specified.
⑥			When the desired bias is displayed, press the key. The display of the specified bias will change from a flashing to a constantly lit display, and 'BIAS' will begin to flash instead.
⑦	 		If you wish to specify other measuring conditions settings, press the key to select the menu. To exit from specifying measuring conditions settings, press the key instead.

9. Menu Settings

MOC-120H provides the capability to specify and select between different measurement bases, data output formats, and other menu settings. All desired settings should be specified before conducting measurements.

The procedure used when changing menu settings is the same as the procedure used when specifying menu settings for the first time. Note that menu settings are automatically internally saved, and that there is no need to specify menu settings before each measurement.

9-1 Types of Menu Settings







Menu	Menu display (Menu items)				Description
UNIT (Measurement base)	Step 1		Step 2 minimum display (%)		Used to select one of three possible measurement bases. It is also possible to switch % display. (For further information, see “9-2-1 Selecting a measurement base and switching % display”)
	MW (Wet base) MD (Dry base) SOL (Solid)		0.01		
			0.1		
OUTPUT (Measurement data output)	Step 1	Step 2		Step 3	Used to specify the format in which data is to be output to a printer or computer. The user may select the external device to which output is sent and the format in which data is to be output. When graph output (‘GRP’) has been selected, it is also possible to specify the minimum and maximum values to be used in the range of measurements. (For further information, see “9-2-2 Specifying the type and format of output”)
	PC (Output to computer)	30S (30 secs.) 1M (1 min.)		/	
	TBL (Output in tabular format to printer)	2M (2 min.) 5M (5 min.)			
	GRP (Output as graph to printer)	10M (10 min.) FIN (Final result)	0.00% 0.00%		
CODE (Sample code)	0000				Used to specify the sample code to be output to printer or computer. (For further information, see “9-2-3 Specifying sample codes”)
DATE (Date & time)	Step 1	Step 2	Step 3	Step 4	Used to set the internal clock. This date and time is output as the ‘Measurement time’ printed together with any output data to a printer or computer. (For further information, see “9-2-4 Setting the date and time”)
	YMD	Year	Month/Day	Time	
	MDY	Month/Day	Year	Time	
	DMY	Day/Month	Year	Time	
CAL (Calibration)	WCAL (Balance calibration)				Used to calibrate the balance. (For further information, see “9-2-5 CAL (Balance calibration)”)

* In addition to these settings, it is also possible to specify other settings such as the device ID (see “9-2-6 Specifying a device ID”) or password (see “9-2-7 Specifying a password”).

9-2 Descriptions of Individual Menu Items

Descriptions of individual menu items are given in subsection 9-2-1 and below.

Menu operation

- ① Calling up menu settings: To call up menu settings, press the  key from the weight display.
- ② Selecting individual menu items: When the  key is pressed, the menu item ‘UNIT’ will light up. Pressing the  key here causes the menu item lit up to change from ‘UNIT’ → ‘OUTPUT’ → ‘CODE’ → ‘DATE’ → ‘CAL’ and back to ‘UNIT’ in sequence each time the  key is pressed. When the item for which you wish to specify settings is displayed, press the  key. The settings for the selected item may then be specified.
- ③ Exiting from menu settings: Pressing the  key when any menu item is currently lit up exits from menu settings mode and returns to the regular weight display.

9-2-1 Selecting the measurement base and switching the % display

1) Selecting the measurement base

This menu item is used to specify what measurement base is to be used in measurements. There are three different types of bases: wet base, dry base, and solid. The type of base specified should be selected in accordance with the sample being measured.

Type	Menu display	Formula	Description
Wet Base	MW	$\frac{W - D}{W} \times 100 (\%)$	Percentage of evaporated moisture weight with respect to the weight before drying.
Dry Base	MD	$\frac{W - D}{D} \times 100 (\%)$	Percentage of evaporated moisture weight with respect to the weight after drying.
Solid	SOL	$\frac{D}{W} \times 100 (\%)$	Percentage of residual weight after drying with respect to the weight before drying.

Notation used in formulas:

W: Wet weight before measurement













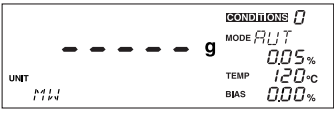

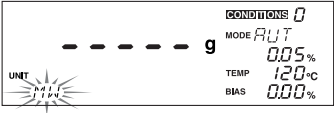

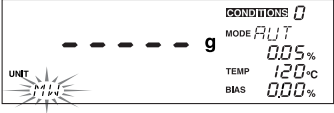



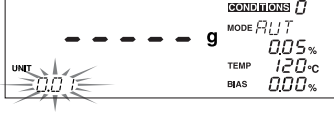

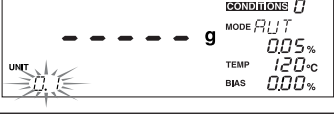
D: Dry weight after measurement

(While measurement is being performed, the weight at each point in time is used as the dry weight in calculating measurements.)

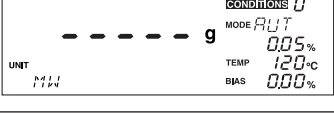
2) Switching the minimum display of percentage

This menu item is used to switch the minimum display of the measurement result between 0.1% and 0.01%.

■ How to select a measurement base

Step	Key(s) used	Display	Operating instructions
①			With the display displaying the weight in grams, press the  key.
②			The 'UNIT' menu item will light up and the currently selected measurement base will be displayed.
③			Press the  key. This will cause control to shift to specification of 'UNIT' settings and for the currently selected measurement base to begin to flash.
④			Press the  key until the desired measurement base is displayed. The flashing item will change from 'MW' → 'MD' → 'SOL' and back to 'MW' again in sequence each time the  key is pressed. Note that here wet base ('MW') has been selected.
⑤			When the desired measurement base flashes, press the  key. The currently selected % display begins to flash.
⑥			Press the  key until the desired % display is displayed. The flashing item will change from '0.01' to '0.1' and back to '0.01' again in sequence each time the  key is pressed. Note that here % display ('0.1') has been selected.
⑦			When the desired % display flashes, press the  key. The display of the selected measurement base will change from a flashing to a constantly lit display and control will return to step ②.
⑧	 		If you wish to specify other menu settings, press the  key to select the desired menu item. If you wish to exit from specifying menu settings, press the  key.

9-2-2 Specifying the type and format of output

The MOC-120H may be connected to the optional printer or computer so that measurement data can be output.

- ① There are three types of output formats as shown in the table below.

External device	Output format	Menu display	Description
Computer	Numeric	PC	This is the setting which should be selected when using the "Windows Direct Function" or some other software to output data through the RS-232C interface.
Printer	Numeric	TBL	This setting causes numeric output to the optional printer.
	Graph	GRP	This setting causes graph output to the optional printer.

- ② Any one of the six output intervals shown below may be selected to specify the frequency at which output is to be generated.

The output interval specifies the amount of time which is allowed to elapse during measurement before the next set of output is generated. When there is no need to view intermediate data, 'FIN' may be selected so that only the final results are output.

- * 'FIN' should never be selected when graph output has been selected when operating in preparatory measuring mode as that would result in no predicted measurements being output.

Output interval	Menu display
Every 30 seconds	30S
Every minute	1M
Every 2 minutes	2M
Every 5 minutes	5M
Every 10 minutes	10M
Final results only	FIN











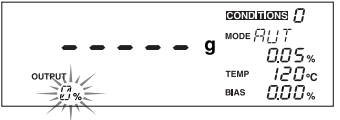

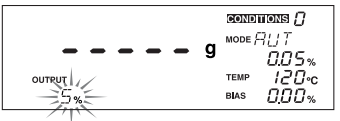



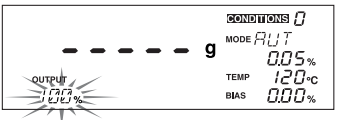

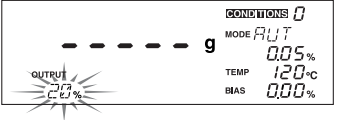

- ③ When graph output has been selected, it is possible to specify the maximum and minimum values of the range of values to be measured in 5-percent increments.

Measurement base	Range of values to be measured
Wet base (%), Solid (%)	Minimum: From 0 to (Maximum -5%) (Specified in 5-percent increments; may be set to any value from 0~95%.)
	Maximum: From (Minimum +5%) to 100 (Specified in 5-percent increments; may be set to any value from 5~100%.)
Dry base (%)	Minimum: From 0 to (Maximum -5%) (Specified in 5-percent increments; may be set to any value from 0~495%.)
	Maximum: From (Minimum +5%) to 500 (Specified in 5-percent increments; may be set to any value from 5~500%.)

■ How to specify the output format to be used

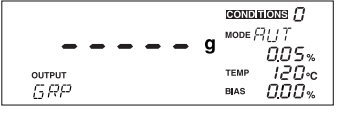
Step	Key(s) used	Display	Operating instructions
①	MENU		With the display displaying the weight in grams, press the MENU key.
②	SELECT		Press the SELECT key until the 'OUTPUT' menu item is displayed.
③	ENTER		Press the ENTER key. This will cause control to shift to the output settings and cause the currently selected output format to flash.
④	SELECT		Press the SELECT key until the desired output format is displayed. Pressing the SELECT key here causes the menu item lit up to change from 'TBL' → 'GRP' → 'PC' and back to 'TBL' in sequence each time the SELECT key is pressed. Note that here 'TBL' has been selected.
⑤	ENTER		When the desired output format begins flashing, press the ENTER key. This will cause control to shift to the specification of the output interval and the currently specified interval flashes.
⑥	SELECT		Press the SELECT key until the desired output interval is displayed. Pressing the SELECT key here causes the menu item lit up to change from '30S' → '1M' → '2M' → '5M' → '10M' → 'FIN' and back to '30S' in sequence each time the SELECT key is pressed. Note that here an interval of '1M' has been selected.
⑦	ENTER SELECT MENU		When the desired output interval flashes, press the ENTER key. The next step to be performed here differs depending on the output format specified in step ④. Procedure when 'TBL' has been selected: The currently specified output format will be displayed and the control will return to the format step ②. If you wish to specify other menu settings, press the SELECT key to select the desired menu. If you wish to exit menu settings, press the MENU key. Procedure when 'GRP' has been selected: Control will shift to the specification of the range of data output (described in step ⑧ to ⑫).

Specifying the range of measurement values to be used (when 'GRP' has been selected)

Step	Key(s) used	Display	Operating instructions
⑧			The currently selected lower limit of the range of data output will begin to flash.
⑨	 		Press the  key or  key until the desired lower limit is displayed. Note that here a value of '5%' has been selected.
⑩			When the desired lower limit flashes, press the  key. This will cause the upper limit of the range of data output begin to flash.
⑪	 		Press the  key or  key until the desired upper limit is displayed. Note that here a value of '20%' has been selected.
⑫	  		When the desired upper limit flashes, press the  key. The currently specified output format will be displayed and the display will return to the state shown in step ②. If you wish to specify other menu settings, press the  key. If you wish to exit from specifying menu settings, press the  key.















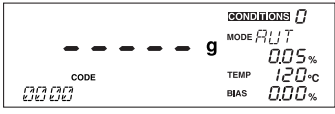

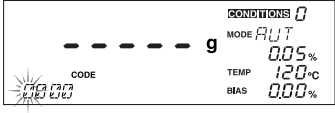



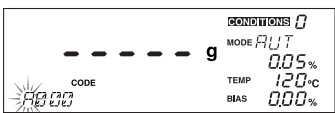

9-2-3 Specifying sample codes

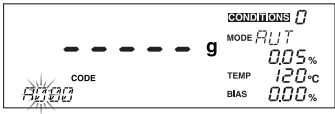
This section describes how to specify sample codes to be used when outputting measurements to the optional printer or a computer. Sample codes may be specified as 4-character codes.

- Any digit from 0 to 9, and letter from A to Z, or a hyphen “_” may be specified as the value of the first or second character of the code.
- Only digits from 0 to 9 may be specified as the value of the third and fourth character and the code.

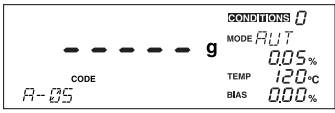
* The digits in the third and fourth characters of the code are automatically increased by 1 after each measurement, with the value returning to ‘00’ when it would otherwise exceed a value of ‘99’.

■ How to specify sample codes

Step	Key(s) used	Display	Operating instructions
①			With the display of the weight in grams, press the  key.
②			Press the  key until the ‘CODE’ menu item is displayed.
③			Press the  key. Control will then shift to the specification of the sample code and the first character of the currently selected sample code will flash.
④	 		Press the  key or  key to select a digit from ‘0’ to ‘9’ or a letter from ‘A’ to ‘Z’. Note that here ‘A’ has been selected.
⑤			When the desired character has been displayed, press the  key. The first character will be fixed and the second character will flash.
⑥			Repeat steps ④ and ⑤ until the fourth character has been specified. When the fourth character has been specified, press the  key.
⑦			The sample code just specified will then be displayed and the display will return to the step ②.
⑧	 		If you wish to specify other menu settings, press the  key. To exit from specifying menu settings, press the  key instead.

9-2-4 Setting the date and time

This section describes how to set the date and time. Also note that the date and time of measurement are output whenever measurement data is output to the optional printer or a computer.

■ How to set the date















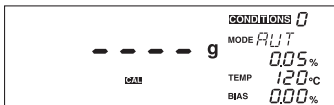









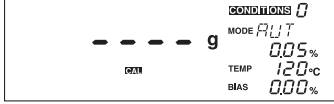

Step	Key(s) used	Display	Operating instructions
①	MENU		With the display of the weight in grams, press the MENU key.
②	SELECT		Press the SELECT key until the 'DATE' menu item is displayed.
③	ENTER		Press the ENTER key. This will cause control to shift to DATE output format setting and the currently selected output format to be displayed. * The output format will be displayed in the order 'YMD' (year, month, day, and time), 'MDY' (month, day, year, and time), and 'DMY' (day, month, year, and time).
④	SELECT		Press the SELECT key until the desired output format is displayed. Each time the SELECT key is pressed the display will change from 'YMD' → 'MDY' → 'DMY' and back to 'YMD' again. Note that here 'YMD' has been specified.
⑤	ENTER, ▲, ▼		When the desired output format is displayed, press the ENTER key. This will cause control to shift to the specification of the year and the currently specified 2-digit value flashes. Press the ▲ key or ▼ key to display the correct 2-digit year.
⑥	ENTER, ▲, ▼		Pressing the ENTER key causes the year to be set and control to shift to the specification current month. Press the ▲ key or ▼ key to select the correct 2-digit month.
⑦	ENTER, ▲, ▼		Pressing the ENTER key causes the month to be set and control to shift to the specification of the date. Press the ▲ key or ▼ key to display the correct 2-digit day.
⑧	ENTER, ▲, ▼		Pressing the ENTER key causes the date to be set and control to shift to the specification of the 2-digit value for the hour. Press the ▲ key or ▼ key to select the correct 2-digit hour.
⑨	ENTER, ▲, ▼		Pressing the ENTER key causes the hour to be set and control to shift to the specification of the 2-digit value for the minutes. Press the ▲ key or ▼ key to select the correct 2-digit minutes.
⑩	ENTER		Pressing the ENTER key causes the minutes to be set and only 'DATE' to be displayed. (The clock will start counting from 0 seconds from the moment when the ENTER key is pressed.)
⑪	SELECT, MENU		If you wish to specify other menu settings, press the SELECT key. To exit from specifying menu settings, press the MENU key instead.

9-2-5 CAL (Balance calibration)

The internal balance of the MOC-120H may be calibrated at two points: at the 0 and 100grams. The MOC-120H may also be connected to a printer to make it possible to automatically generate calibration records in compliance with GLP, GMP, and ISO standards.

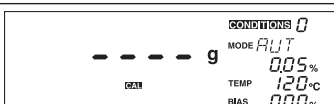
- * The power to the unit should be turned on at least 30 minutes before calibration is performed in order to ensure accurate calibration.
- * The MOC-120H is extremely sensitive to interference from drafts, breezes, vibration, and other disturbances in the surrounding environment, and care should be taken to ensure that there is no such interference before performing calibration.
- * It is impossible to calibrate the balance accurately immediately after performing measurements or at any other time when the heater lid is hot. Allow the temperature of the heater lid to cool down to ambient temperature before performing calibration.
- * The weights used should consist of standard OIML weights or some other type of non-magnetic Class 1 weights. (The use of Class E2 or Class E1 weights is recommended.)
- * When placing the weight on the sample pan, it should be placed in the center of it.
- * The heater lid must be closed during calibration to prevent influence of drafts or air flow, and the height of the weights used should be such that they do not come into contact with the temperature sensor or heater.
- * If you wish to abort a calibration already in progress, press the  key. An 'Abort' message will be displayed and the display will return to the weight in grams.

■ Scale calibration procedure

Step	Key(s) used	Display	Operating instructions
①			With the display of the weight in grams, press the  key.
②			Press the  key until the 'CAL' menu item is displayed.
③			Press the  key. This will cause the calibration settings to be displayed and the setting '100.000' to flash.
④	   		If you wish to change the value of the weight to be used, then press the  key. This will cause the displayed value to stop flashing. Next, press the  key or  key to enter a value for the weight. Pressing the  key then causes the specified weight value to flash.
⑤		 	Open the heater lid and place a calibration weight of the specified weight value on sample pan. Closing the heater lid and pressing the  key causes '- - -' to be displayed, 100-gram calibration to come to an end, and then a flashing value of '0.000' to be displayed.
⑥		 	With the value '0.000' flashing, open the heater lid and remove the calibration weight. Closing the heater lid and pressing the  key causes '- - -' to be displayed, 0-point calibration to come to an end, and then an 'END' message to be displayed. * If the unit is connected to the optional printer, a calibration record will be automatically printed out.
⑦			After a few seconds, the display will return to the regular weight display.

9-2-6 Specifying a device ID

This section describes how to specify the device ID output when outputting data to the optional printer or a computer. The device ID is an 8-character ID which may be set using the following characters: digits from 0 to 9, letters from A to Z, and hyphens ‘—’.

■ How to specify a device ID













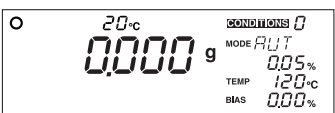



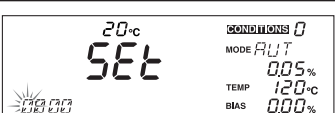

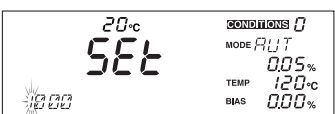



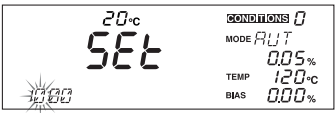

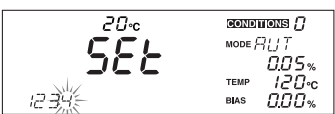

Step	Key(s) used	Display	Operating instructions
①	SELECT MENU		From the weight display, press the SELECT key and hold the SELECT key down while pressing the MENU key.
②			The first through fourth characters of the device ID will be displayed with the first character flashing. The indicator ‘id’ will be displayed in the center of the display.
③	▲ ▼		Press the ▲ key or ▼ key to select the desired character for the first character (i.e., a digit from 0 to 9, a letter from A to Z, or a hyphen). Note that here the letter ‘A’ has been selected.
④	ENTER		When the desired character is displayed, press the ENTER key. The first character will be specified and the second character will flash.
⑤	ENTER		Repeat steps ③ and ④ until the fourth character has been specified. Note that here ‘ABCD’ has been specified. When the fourth character has been specified, press the ENTER key.
⑥			The fifth through eighth characters of the device ID will then be displayed with the first of these four characters flashing.
⑦			Just as with the first four characters, repeat steps ③ and ④ until the eighth character has been specified. Note that here ‘—123’ has been specified.
⑧	ENTER		When the eighth character has been specified, press the ENTER key. The display will then return to the regular weight display.

9-2-7 Specifying a password

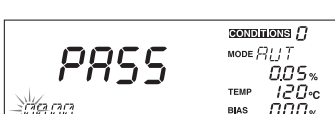
In order to prevent the specified measuring conditions from being modified unexpectedly, a password may be specified to prevent other users from changing the specified conditions. The password is 4 characters in length and may be set using the following characters: digits from 0 to 9, letters from A to Z, and hyphen.

If any password other than the default password of '0000' is set, then whenever the  key is pressed to specify measuring conditions 'PASS' is displayed and the user is required to enter the password.

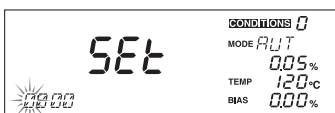



■ How to specify a password

Step	Key(s) used	Display	Operating instructions
①	 		From the weight display, press the  key and hold the  key down while pressing the  key.
②			The default password of '0000' will be displayed with the first character of the password flashing. The indicator 'SEt' will be displayed in the weight display area.
③	 		Press the  key or  key to select the desired character (i.e., a digit from 0 to 9, a letter from A to Z, or a hyphen). Note that here the letter '1' has been selected.
④			When the desired character is displayed, press the  key. The first character will be set and the second character will flash.
⑤			Repeat steps ③ and ④ until the fourth character has been specified. Note that here a value of '1234' has been specified.
⑥			When the fourth character has been specified, press the  key. The display will then return to the regular weight display.
[Deleting or modifying an existing password]			
⑦	 		To delete or modify an existing password, press the  key and hold the  key down while pressing the  key from the weight display. The indicator 'PASS' will be displayed in the weight display area and the first character of the default password '0000' will begin to flash. Repeat steps ③ and ④ until you have entered the current password.
⑧			When the 4-character password has been entered, press the  key. The indicator 'SEt' will be displayed in the weight display area. The value '0000' will be displayed in the password area with the first character flashing; repeat steps ③ to ⑥ to specify a new password. To delete a password, enter '0000' as the new password.

10. Error Messages

If any of the following error messages is displayed, follow the procedures described below to check for the cause and take appropriate action.

If the error cannot be removed, contact your Shimadzu representative.

Message	Description	Action to be taken
Er102	The protective sheet has not been removed.	Remove protective sheet located under the pan supporter column. (See item ③ in “6. Assembly and Installation of Main Unit” on p. 9 for instructions.)
Er103	The sample is too light (i.e., under 0.5 grams).	The minimum weight which may be measured by the MOC-120H is 0.5 grams. Measure again using a sample with a weight of 0.5 grams or greater. Press the  key to make the error message disappear.
Er104	The sample is too heavy (i.e., over 120 grams).	The maximum weight which may be measured by the MOC-120H is 120 grams. Measure again using a sample with a weight of 120 grams or smaller. Press the  key to make the error message disappear.
Er201	Invalid moisture content value (Occurs when weight increases by more than 0.1 grams)	This error is displayed when a sample is added during measurement. Press the  key to make the error message disappear.
Er202	Invalid moisture content value (Occurs when weight being measured is less than -1 grams)	Press the  key to make the error message disappear.
Er401	Balance communications error	Turn off the power and then turn the power on again.
Er501	Invalid calibration weight	Use a calibration weight of the correct weight value.
Er502	Instability during balance calibration	Perform balance calibration again with the MOC-120H placed on a flat, stable surface not subject to the effects of external vibration, drafts, or breezes.
Er701	Power error	Turn the power off, make sure that the power conversion switch located on the back is set to the correct position.

If any of the following errors are displayed, contact your Shimadzu representative.

Message	Description
Er301 Er302	Temperature sensor failure
 Er303	Heater overheated This error indicates the existence of an extremely hazardous condition. Turn the power off immediately and contact your Shimadzu representative.
Er305	Heater control failure
Er306	Heater lid is open during measurement (for 15 sec.).
Er601 Er602 Er603	Lift mechanism failure
Er802	Internal clock failure

11. Precaution on Conducting Measurements

● Precaution on conducting multiple measurements in succession

Placing a sample on the sample pan which is already warm may cause moisture from the sample to evaporate before measuring is begun and causes errors in measurement result. Always be sure to use a cool sample pan when performing a subsequent measurement.

Allow an even amount of time to elapse between measurements, as errors may occur if the temperature of the balance mechanism varies.

- * **Two sample pans and two sample pan handlers are provided for use when conducting multiple measurements in succession.**

● Use of sample pan and aluminum foil sheets

It is impossible to obtain accurate measurements if any of the last measured sample remains on the sample pan. To avoid errors, either wipe the sample pan clear of any remaining sample (see “15. Maintenance” on p. 58 for further instructions) or use disposable aluminum foil sheets.

- * **Twenty disposable aluminum foil sheets are included with the unit.**

● Quantity and placement of powdered, particulate and viscous sample materials

Samples cannot be heated properly if they are not placed flatly. Placing samples in mounds or in layers of varying thickness may result in the highest points being burned. accurate measurements. The precision of measurement improves when the samples are flatly and evenly placed and the amount of sample are larger. However, too large sample amount results in uneven heating. Make certain samples are placed correctly.



● Measuring liquid samples

Since most liquid samples harden and become sticky after drying, it is recommended to use the aluminum foil sheets when measuring such samples. Note that the aluminum foil sheet is water-wettable, thus making it possible to obtain wide and even sample placement and effective in shortening measuring times and obtaining accurate measurements.

Depending on the sample, the use of sand to speed up drying (Silica sand or ocean sand with a mesh of 20 or so).

12. Predictive Measurements

12-1 A Description of Predictive Measuring

Electronic moisture balance can be used to measure the moisture content of a wide range of materials. This is the most important feature not found in other types of moisture testers. However, because moisture balance operates by heating samples to evaporate the moisture content, it takes a fair amount of time to obtain results. MOC-120H has a feature that not only reduces measuring times but also brings the method to adjust partial drying measurement results to those obtained with a standard method of measuring. The feature is called predictive measuring mode.

In predictive measurement:

- (1) The final moisture content is predicted while drying is still in progress.
- (2) Three additional settings must be specified before measuring: the drying temperature, the predicted value convergence range, and bias.
- (3) Only sample materials which produce what are usually referred to as S-shaped drying curves can be measured.

The bias may also be used to correct for differences in measurements obtained with other moisture content testers.

● Drying temperature

Since the measurements obtained in predictive measuring mode are treated as comparable to the measurements obtained by automatic operation mode, the drying temperature should be set to the same temperature as in automatic operation mode.

● Predicted value convergence range

When measuring in predictive operating mode, the predicted values are internally calculated every 30 seconds, and while variation occurs in the calculated values the degree of variation becomes smaller as time elapses. The range of variation in moisture content specified in order to confirm a predicted value as the final is referred to as the predicted value convergence range. The MOC-120H treats the predicted value as final when the range of variation falls within the "predicted value convergence range"

The predicted value convergence range may be set to a value anywhere from 0.1 to 9.9 percent. Specifying a higher value for the predicted value convergence range causes the final predicted value to be determined quickly. On the other hand, the specification of a higher value may also result in greater degree of error. It is possible to obtain more precise sets of predicted values by specifying lower values. This takes longer to determine the final predicted value. The predicted value convergence range should be specified according to your objectives. Note that the default setting for the MOC-120H is a value of 0.5 percent.

● Bias

Bias is used to adjust the predictive measurement. On the MOC-120H, a bias of anywhere from -9.99 to +9.99 percent may be specified. When performing a preparatory (COMPARE) measurement, the MOC-120H automatically indicates the most appropriate bias to be used to correct measurements to match those obtained in automatic operation mode.

● Bias can be used for correction against other methods

When seeking the bias to perform correction against another method, the bias should be reset to zero and then a number of samples with known moisture contents have to be measured with predictive measurements and the average difference between the known moisture contents and the predicted moisture contents should then be specified as the bias.

● Preparatory measuring mode

In preparatory measuring mode, predicted measurements are displayed while measuring is in progress and measuring is halted under the same conditions as when operating in automatic operation mode. The difference between the measured values of automatic operation mode and predictive measuring mode is displayed as the necessary bias.

In order to obtain accurate predicted measurements, it is recommended to perform at least 5 preparatory measurements and take the average to determine the bias.

You should also take care in terms of the amount of the sample and the way the sample material is placed onto the sample pan. They must be the same every time and laid out as evenly as possible.

● Predictive measuring mode

Prior to predictive measurements, specify the same drying temperature, predicted value convergence range, and bias as calculated from preparatory measurements.

Note that measuring is halted if no predicted measurement has been calculated after 30 minutes have elapsed after starting the measurement.

12-2 Procedure for Obtaining Predicted Measurements

- 1) Use preparatory measuring mode to obtain the appropriate bias value for the predictive measurement. (See “12-2-1 Calculating the bias to be specified when operating in predictive measurement mode” for instructions.)
- 2) Use the bias obtained in preparatory measuring mode in step 1) to perform the measurement, and evaluate the predicted measurement. (See “12-2-2 Evaluating predicted measurements” for instructions.)
- 3) Measure in predictive measuring mode. (See “12-2-3 Performing predictive measurements” for instructions.)

12-2-1 Calculating the bias to be specified when operating in predictive measurement mode

Step	Display	Operating instructions
①		Set the mode to preparatory measuring mode. (See 8-2-2 “6) Specifying settings for preparatory measuring mode” for instructions.)
②		Specify the desired predicted value convergence range. In the example shown here, a range of 0.5% is specified. <ul style="list-style-type: none"> • Note that the predicted value convergence range specified affects the amount of time required for measurement and the accuracy of predictive measurements, and that you should specify a range according to your objectives.
③		Specify the automatic halting conditions to be used (e.g., 0.05%).
④		Specify the drying temperature to be used. (For further information, see “8-2-3 TEMP (Drying temperature)”.) In the example shown here, a temperature of 120°C is specified.
⑤		Set the bias to 0.00%. (See “8-2-4 Bias” for further information.)
⑥		Place the sample onto the sample pan and begin measurement. (In the example shown here, the initial weight is 10.478 grams.)
⑦		When the final predicted value has been calculated, it will be displayed. (In the example shown here, the measuring time was 7 minutes and the predicted measurement is 15.8 percent.)

Step	Display	Operating instructions
⑧		<p>Completion of measurement Measuring will be completed when the conditions specified for automatic operation mode have been met. When measuring is completed, the bias will be displayed in the bias display area.</p> <p>[Measurement results]</p> <p>Bias is + 0.60 (= 16.40 (Automatic operation mode value) – 15.80 (Predicted measurement))</p> <p>Automatic operation mode measurement</p> <p>Predicted measurement</p>
⑨		<p>Without changing any of the conditions used in steps ① through ⑤, repeat steps ⑥ through ⑧ to measure again 5 times or more and calculate the average bias.</p> <p>The average bias may then be used to specify the bias to be used in predictive measuring mode.</p> <p>* If the bias varies greatly from one time to the next when performing repeated measurements, predicted measurement cannot be obtained, and you should measure in automatic operation mode or in some other mode instead.</p>
⑩		<p>If you wish to use the calculated bias to evaluate predicted measurements, follow the procedure described in “12-2-2 Evaluating predicted measurements”. If you wish to use the calculated bias to actually perform predictive measurements, follow the procedure described in “12-2-3 Performing predictive measurements”.</p>

12-2-2 Evaluating predicted measurements

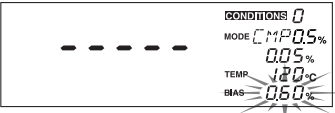
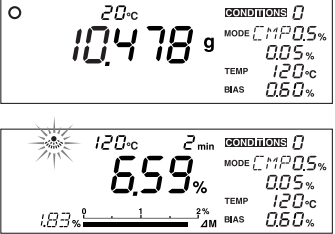
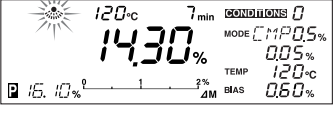
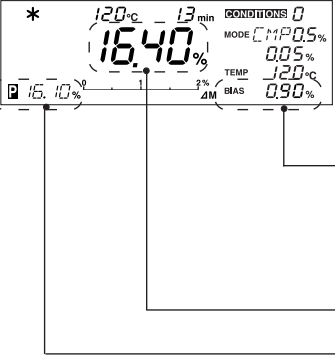
Step	Display	Operating instructions
①		<p>With the mode set to preparatory measuring mode, set the bias obtained by the procedure described in 12.2.1. In the example shown here, a bias of 0.60 percent has been specified. (For information on how to set the bias, see “8-2-4 Bias”.)</p> <p>* Do not change any other settings (i.e., the predicted value convergence range and drying temperature) at this time.</p>
②		<p>Place the sample onto the sample pan and begin measurement. (In the example shown here, the initial weight is 10.478 grams.)</p> <p style="text-align: center;">⋮</p>
③		<p>When the predicted measurement result has been obtained, a predicted measurement adjusted by the specified bias (here a bias of 0.60%) will be displayed. (In the example shown here, the measuring time was 7 minutes and the predicted measurement is 16.10 percent.)</p> <p style="text-align: center;">⋮</p>
④		<p>Completion of measurement Measuring will be completed when the conditions specified for automatic operation mode have been met.</p> <p>Measurement results</p> <p>Bias is '+ 0.90' (= 16.40 (Automatic operation mode value) – 15.50 (Predicted measurement when bias is '0'.))</p> <p>* Note that the specified bias (0.60%) does not affect the bias displayed here.</p> <p>Automatic operation mode measurement</p> <p>Predicted measurement adjusted using specified bias of 0.60% = 15.50 (i.e., predicted measurement when bias is '0') + 0.60 (i.e., specified bias)</p>
⑤		<p>Without changing any of the specified in step ①, repeat steps ② through ④ to measure again 5 times or more and obtain a comparison of the values between automatic operation mode and predictive measurement mode.</p> <p>If the difference between the two sets of values is within an allowable range, then the specified bias may be judged to be an appropriate one. If the difference between the two sets of values exceeds allowable levels, then the average bias from the comparison just performed should be calculated and specified as the new bias. The evaluation process should be performed again.</p> <p>* If the difference between the two sets of values exceeds allowable levels and the bias varies sharply over repeated measurements, it is assumed that predictive measurement cannot be properly performed. You should measure in automatic operation mode or in some other mode instead.</p>

12-2-3 Performing predictive measurements

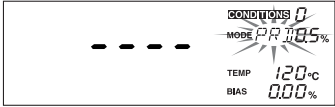
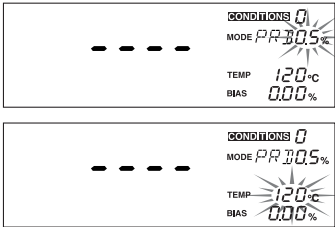
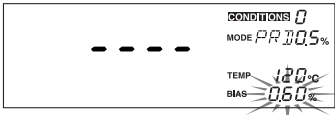
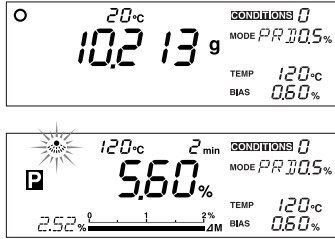
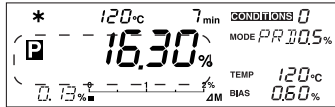
Step	Display	Operating instructions
①		Set the mode to predictive measuring mode. Refer to 8.2.2 “7 Specifying settings for PREDICT (Predictive measuring) mode” for instructions.
②		Specify the same settings for the predicted value convergence range and drying temperature as those used in preparatory measuring mode (subsections 12.2.1 and 12.2.2). Example: Predicted value convergence range: 0.5% Drying temperature: 120°C
③		Set the bias obtained through the procedures described in 12.2.1 and 12.2.2 (shown here as 0.60%). (See “8-2-4 Bias” for setting.)
④		Place the sample onto the sample pan and begin measurement. (In the example shown here, the initial weight is 10.213 grams.) : : :
⑤		Completion of measurement The predicted measurement will then be displayed.

13. Temperature Calibration (Option required)

Temperature calibration can be performed with the optional temperature calibration kit. The calibration record meeting with GLP/GMP/ISO requirements can be automatically produced with the optional printer.

Caution

Do not touch heater cover and the sensor probe or holder of temperature calibration kit during temperature calibration as they become very hot. Touching these parts may cause serious burning.

- The environmental conditions such as ambient temperature and air movement affect temperature calibration. Perform temperature calibration without surrounding air movement and under the same conditions as when performing measurements.
- Press the  key to discontinue a once started temperature calibration. "Abort" is displayed and it returns to the weight display.
- For the operation of digital thermometer of temperature calibration kit, refer to its instruction manual.

Installation of Temperature Calibration Kit (Option)

① Assembling temperature calibration kit:

Insert the sensor probe into the brackets on the holder as shown in the figure.

Place the end of sensor probe in the bracket in holder's center.

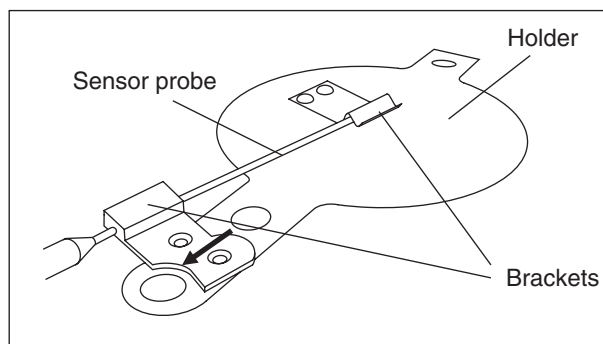

② Open heater cover and place the temperature calibration kit over the sample pan as shown in the figure.

(Fit the hole of holder to stay of main unit as shown in the figure.)

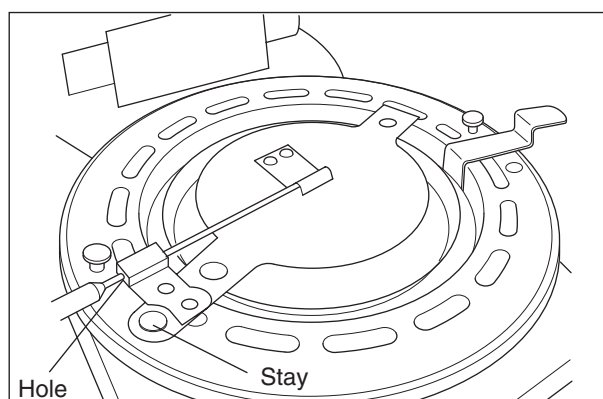



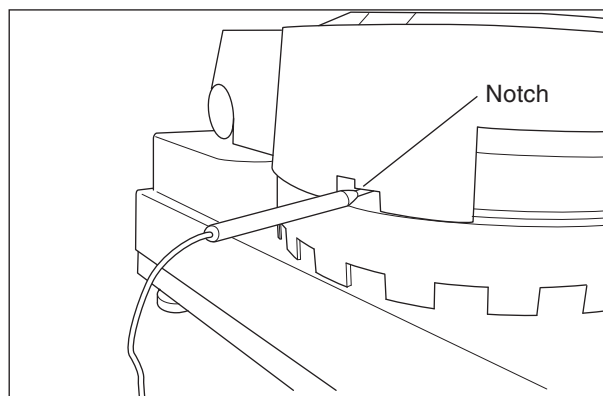











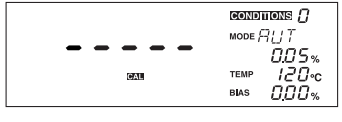

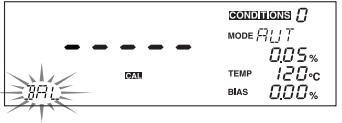

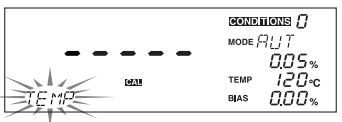

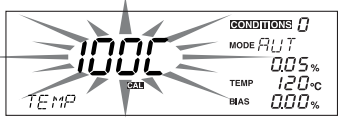



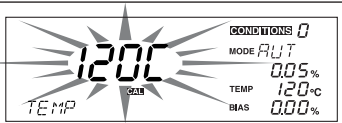





③ Confirm heater cover is completely closed and sensor probe is fitting in the notch of heater cover.

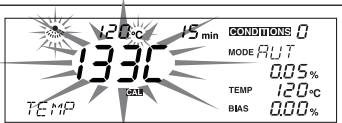

Temperature calibration procedure

The following temperature calibration procedure can be entered only when 'ST' mode is selected as temperature display mode (Refer to 8.1). Verify that the °C symbol in the display is blinking, which indicates that currently selected mode is 'ST' mode.

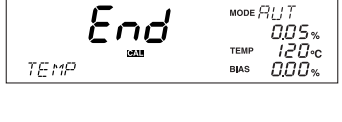
Install temperature calibration kit and switch on digital thermometer in advance.

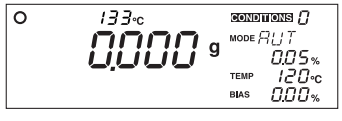
Step	Key(s) used	Display	Operating instructions
①			Press the  key at the weight display.
②			Press the  key repeatedly until 'CAL' is displayed.
③			Press the  key. 'BAL' is displayed.
④			Press the  key repeatedly until 'TEMP' is displayed.
⑤			Press the  key. It moves to the display for inputting the temperature for temperature calibration, and "100C" blinks.
⑥	 		Make up the figure of the desired temperature for temperature calibration with the  ,  keys. Select a temperature close to the most frequently used temperature. Temperature from 50°C to 180°C can be selected. Note that the set temperature here is the heater temperature*.
⑦			Verify heater cover is completely closed. Then, press the [START] key. It heats it up to the temperature that the heater set for the calibrating to begin. Turn on the temperature display of the temperature calibration kit.
⑧			The temperature in heater cover reaches stability in about 15 minutes. Press  key when both temperatures on the main unit and digital thermometer have been stabilized.
⑨	 		Input the temperature indicated on the digital thermometer with the  ,  keys.
⑩			Press  key. First "-----", and then "END" is displayed. Temperature calibration is then complete. The temperature calibration report is automatically output if the optional printer or a computer is connected.
⑪			Wait until it returns to the weight display automatically.

* Select a temperature about 20°C lower than the sample position temperature. Set 80°C if 100°C at the sample position is desired.

14. Printing Output to a Printer (Option)

The MOC-120H may be connected to the optional printer to output measurement data. Output includes data consisting of intermediate or final measurements, sample codes, and measurement times.

14-1 Printer Output Sample

- Output of final results of more than one measurement

[Tabular output (TBL)]

Maker : SHIMADZU CORP	Maker	: SHIMADZU CORP
Model : MOC-120H	Model	: MOC-120H
S/N : D207300000	Serial number	: D207300000
ID : ABCD-123	Device ID	: ABCD-123
Date : 2003.08.08	Time of measurement	: 2003/08/08
Condition No : 0	Measuring conditions storage area	: 0
Unit : Wet Base Moist.	Measurement standard	: Wet base
Temp. mode : Sample plate temp.	Temperature display mode	: Output only when 'ST' mode is selected
Mode : Auto	Measurement mode	: Automatic operation mode
Setting Temp. : 110C	Drying temperature	: 110°C
Auto Stop Cond. : 0.05%	Automatic ending conditions	: 0.05%

Code	Time	Wet-Mass	Dry-Mass	Moist.(%)
A-00	13:03	5.0245	4.4140	12.15
A-01	13:31	5.5402	5.3269	3.85
A-02	14:02	5.1942	4.7745	8.08
A-03	14:33	4.8514	3.9481	18.62
A-04	15:00	5.2647	4.9093	6.75
A-05	15:29	4.7414	4.0335	14.93
A-06	16:00	5.3815	5.3465	0.65

Signature :

Signature title
 * When the measurement is complete, press the  key. This will cause it to be printed.

[Graph output (GRP)]

Maker : SHIMADZU CORP	Maker	: SHIMADZU CORP
Model : MOC-120H	Model	: MOC-120H
S/N : D207300000	Serial number	: D207300000
ID : ABCD-123	Device ID	: ABCD-123
Date : 2003.08.08	Time of measurement	: 2003/08/08
Condition No : 0	Measuring conditions storage area	: 0
Unit : Dry Base Moist.	Measurement standard	: Dry base
Mode : Time	Measurement mode	: Timed operation mode
Setting Temp. : 110C	Drying temperature	: 110°C
Drying Time : 10min.	Measurement time	: 10 mins.

Code	Time	Moist.
		(%) 0 4 8 12 16 20
B-01	10:02	19.54 -----*
B-02	11:00	6.23 -----*
B-03	11:59	15.41 -----*
B-04	13:01	3.95 -----*
B-05	14:02	14.12 -----*
B-06	14:59	14.59 -----*

Sample code
 Time of measurement
 Measurement graph

● Output of the intermediate and final values of a single measurement

[Tabular output (TBL)]

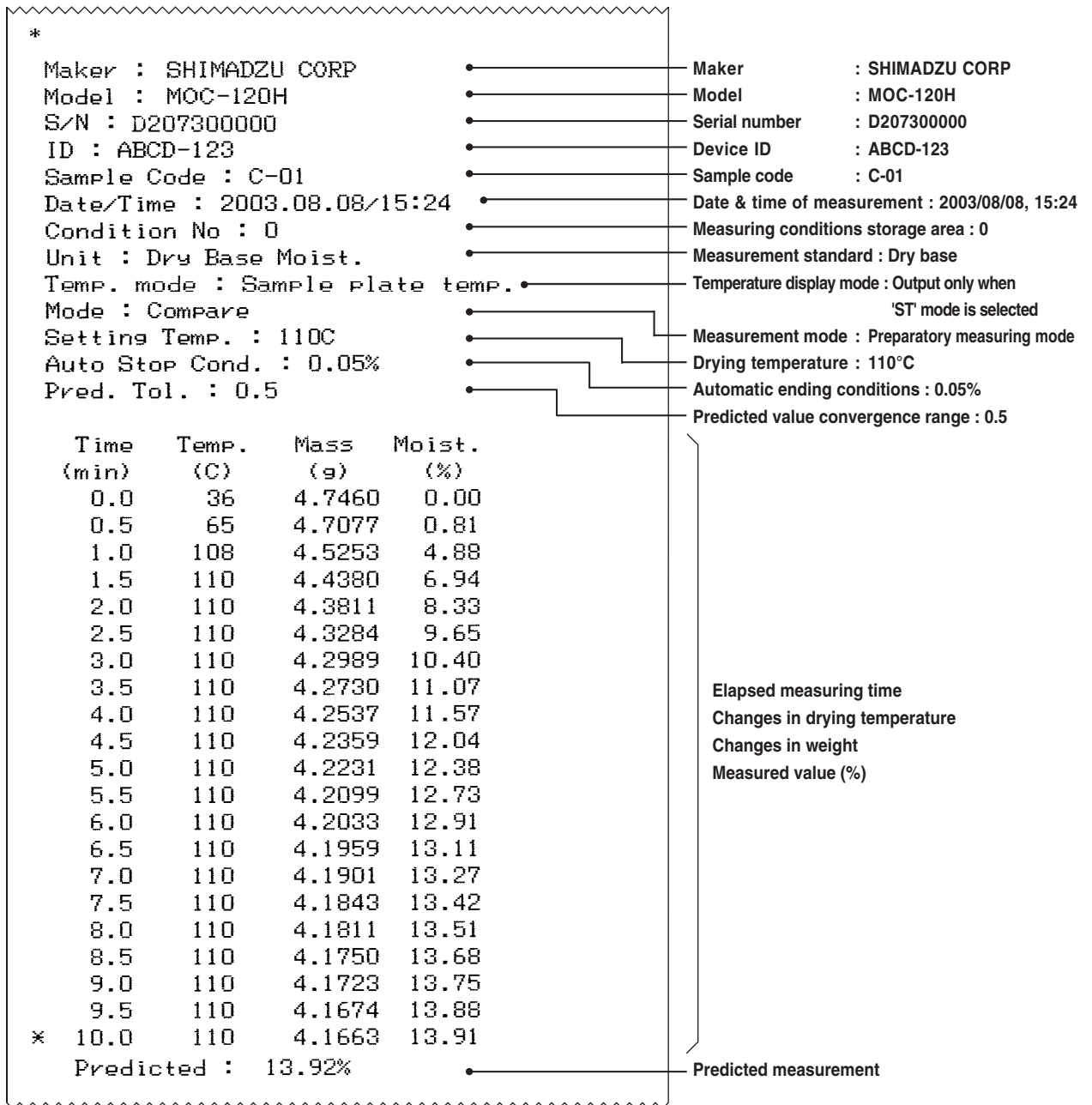

* Note on the decimal precision of printed weight data

Although the minimum weight which may be displayed by the MOC-120H is 0.001 grams, weights are printed to a precision of 4 decimal points because the values printed consist of averages from 7 measurements taken over each 30-second interval for each set of weight data output.

● Output of the intermediate and final values of a single measurement

[Graph output (GRP)]

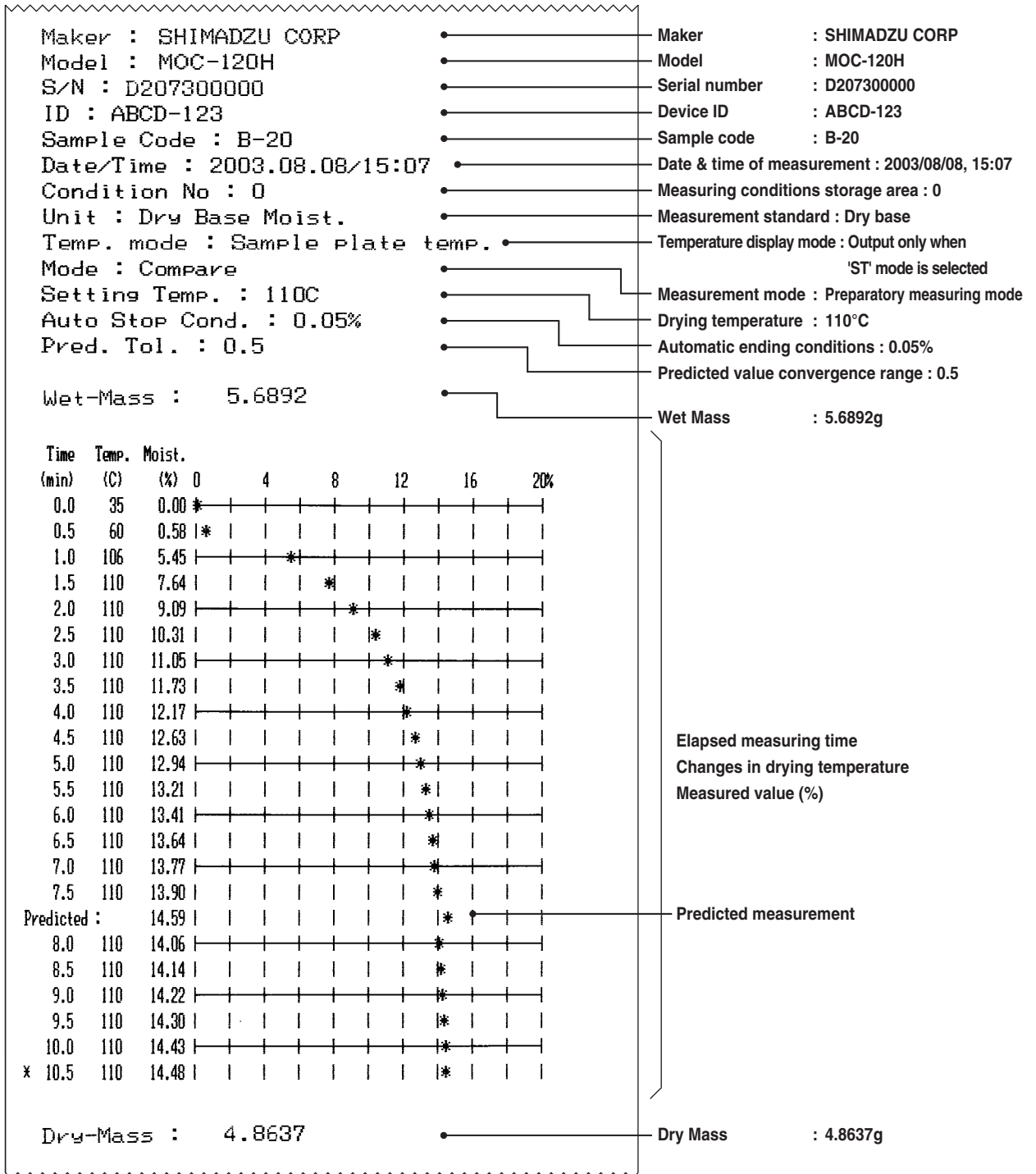





● Output of report of balance calibration

WEIGHT CALIBRATION	
SHIMADZU CORP	Maker : SHIMADZU CORP
Model : MOC-120H	Model : MOC-120H
S/N : D207300000	Serial number : D207300000
ID : ABC-1234	Device ID : ABCD-123
Date/Time : 2003.08.08/15:17	Date & time of measurement : 2003/08/08, 15:17
REF = 100.000g	Reference : 100.000g
BFR = 100.004g	Before calibration : 100.004g
AFT = 100.000g	After calibration : 100.000g
Signature :	Signature title

TEMPERATURE CALIBRATION	
SHIMADZU CORP	Maker : SHIMADZU CORP
Model : MOC-120H	Model : MOC-120H
S/N : D412345678	Serial number : D412345678
ID : 00000000	Device ID : 00000000
Date/Time : 2004.11.22/16:09	Date & time of measurement : 2004/11/22, 16:09
REF = 105C	Reference : 105°C
BFR = 101C	Before calibration : 101°C
AFT = 105C	After calibration : 105°C
Signature :	Signature title

14-2 Outputting Stored Measurement Data

The MOC-120H can store up to 100 sets of previous measurements data, and the stored data can be output to the optional printer or a computer. To output this data:

- ① Follow the directions given on p. 31 in “9-2-2 Specifying the type and format of output” to set the output format to either ‘TBL’ or ‘PC’.
- ② From the weight display, press the  key and hold the  key down while pressing the  key.
- ③ The data will then be output in order beginning from the most recently measured data. To stop printing while printing is still in progress, press the  key.

15. Computer Interface

The RS-232C interface may be used to connect the MOC-120H to a computer.

15-1 RS-232C Interface Specifications

Interface type : RS-232C
Communications method : Asynchronous communication
Baud rate : 2400 bps
Data bits : 8 bits
Parity : None
Stop bits : 1 bit
Connector : Female D-SUB9 pins
Pin assignment :

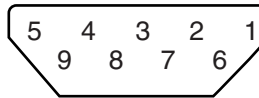

Pin number	Direction	Description
1		Not used
2	Output	TXD
3	Input	RXD
4		Not used
5		GND
6		Not used
7		Not used
8		Not used
9		Not used
Frame		Shield

15-2 Setting Up and Transmitting Data

15-2-1 Connecting the RS-232C cable

With the power to the MOC-120H and the computer both turned off, connect the RS-232C cable. Connect the RS-232C cable to the RS-232C port located at the rear of the MOC-120H and tighten the screws at both sides of the connector. Follow the same procedure to connect the RS-232C cable to the computer. If the MOC-120H has been moved, make sure that the MOC-120H is readjusted the level. (See “6. Assembly and Installation of Main Unit” on p. 9 for instructions.)

15-2-2 MOC-120H settings

Turn on the power to the MOC-120H and set the measurement data output format to ‘PC’. (See “9-2-2 Specifying the type and format of output” on p. 31 for instructions.)

15-2-3 Setting Up the Computer

(leave the balance unplugged)

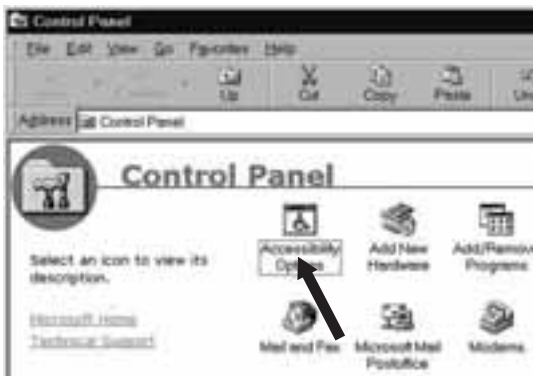

- 1 Turn ON the power to the computer and start Windows®.
- 2 Click “Start”, choose “Settings”, and “Control Panel”.
- 3 Select “Accessibility Options.”
- 4 Verify that there are no check marks for any items on all five tabs including “General.”
- 5 Put a check mark at “Support Serialkey device” in the “General” tab. This should be the only check mark on all the tabs of Accessibility Options unless “Administrative options” appears in the “General” tab. Put check marks at both the items of “Administrative options” to maintain the settings even after restarting Windows®.
- 6 Open “Settings”.
- 7 Select the serial port corresponding to the RS-232C port of your personal computer. (Serial port: any one of COM1 to 4. Usually, COM1)

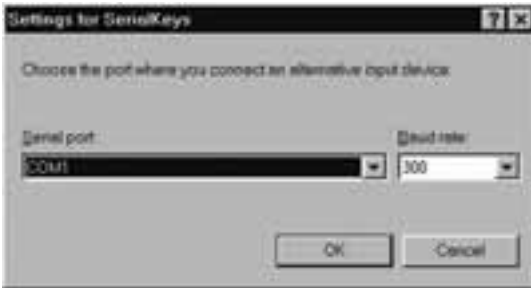

- 8 Select a "Baud rate" of 300.
- 9 Click "OK".
- 10 Click "Apply" and wait.
- 11 Click "OK".



15-2-4 Starting Up the Computer

Turn on the power to the computer and when Windows has started up open the Microsoft Excel or whatever software is to be used to read in data.

- * For instructions on how to use your computer, operating system (Microsoft Windows), or software being used, see the user manuals provided with them.
- * The Microsoft Windows name and logo are the trademarks and registered trademarks of Microsoft Corporation.

The screenshot shows a Microsoft Excel spreadsheet with the following data:

	A	B	C	D	E	F	G
1	SHIMADZU CORP						
2	Model : MOC-120H						
3	S/N : D412345678						
4	ID : 00000000						
5	Code : ST40						
6	Date/Time : 2004.12.08/13:58						
7	Condition : 1						
8	Unit : Wet Base Moist.						
9	Temp mode : Sample plate temp						
10	Mode : Time						
11	Setting Temp : 100C						
12	Drying Time : 30min						
13	Bias : 0.00%						
14		min	C	g	%		
15		0	29	1.0778	0		
16		1	97	1.0585	1.79		
17		2	100	1.0177	5.58		
18		3	100	0.9766	9.39		
19		4	101	0.9615	10.79		
20		5	100	0.954	11.49		
21		6	100	0.9502	11.84		
22		7	100	0.9488	11.97		

A callout box in the spreadsheet contains the text: "Press the [Start] key of the Electronic Moisture Balance."

15-3 Computer Output Format

Interface type	: RS232C
Numeric output format	: JIS (ASCII)
Delimiter code	: 0x09 (tab)
Delimiter	: 0x0D (CR) + 0x0A(LF)

■ Title output format at time of start of measurement

(Underscore characters (i.e., ‘-’) are used below to indicate blanks (i.e., ‘20’ in hexadecimal))

“_SHIMADZU-CORP” + delimiter
“_Model_:_MOC-120H” + delimiter
“_SN_:_” + “_XX” (10-byte Serial No.) + delimiter
“_ID_:_” + “_XX” (8-byte ID) + delimiter
“_Date/Time_:_” + “XX” (2-byte year) + “.” + “XX” (2-byte month) + “.” + “XX” (2-byte day) + “/” +
“XX” (2-byte hour) + “:” + “XX” (2-byte minutes) + delimiter
“_Condition_:_” + “X” (1-byte condition number) + delimiter
“_Unit_:_” + “Wet Base Moist.” or “Dry Base Moist.” or “Solid Content” + delimiter
“_Temp_mode_:_” + “Sample_plate_tem.,” (Output only when 'ST' mode is selected)

- Automatic operation format

“_Mode_:_Auto”
“_Setting_Temp. _:_” + “XXX” (3-byte temperature setting) delimiter
“_Auto Stop Cond. _:_” + “X.XX” (4-byte automatic ending conditions setting) + delimiter

- Timed operation format

“_Mode_:_Time”
“_Setting_Temp. _:_” + “XXX” (3-byte temperature setting) + delimiter
“_Drying_Time_:_” + “XXX” (3-byte drying time setting) + delimiter

- High-speed drying format

“_Mode_:_Rapid”
“_Setting_Temp. _:_” + “XXX” (3-byte temperature setting) + delimiter
Automatic operation: “Auto Stop Cond. _:_” + “X.XX” (4-byte automatic ending conditions setting) + delimiter
Timed operation: “Drying Time_:_” + “XXX” (3-byte drying time setting) + delimiter
“_Delta M_:_” + “X.X” (3-byte 200°C maintenance condition setting) + delimiter

- Low-speed drying format

“_Mode_:_Slow”
“_Setting_Temp. _:_” + “XXX” (3-byte temperature setting) + delimiter
Automatic operation: “Auto Stop Cond. _:_” + “X.XX” (4-byte automatic ending conditions setting) + delimiter
Timed operation: “Drying Time_:_” + “XXX” (3-byte drying time setting) + delimiter

- Stepped mode format
 “_Mode_:_Step”
 tab + “Temp” + tab + “Time” + delimiter
 The following output then appears the same number of times as the number of specified steps:
 “_Step” + “X” (1-byte step number) + tab + “XXX” (3-byte temperature setting) + tab +
 “XXX” (3-byte drying time setting) + delimiter
- Comparative mode format
 “_Mode_:_Compare”
 “_Setting Temp._:_" + “XXX” (3-byte temperature setting) + delimiter
 “_Auto Stop Cond._:_" + “X.XX” (4-byte automatic halting conditions setting) + delimiter
 “_Pred. Tol._:_" + “X.X” (Predicted value convergence range) + delimiter
- Predictive mode format
 “_Mode_:_Predict”
 “_Setting Temp._:_" + “XXX” (3-byte temperature setting) + delimiter
 “_Auto Stop Cond._:_" + “X.XX” (4-byte automatic halting conditions setting) + delimiter

■ Measurement output format

tab + “Time (min.)” + tab + “Temp. (C)” + tab + “Weight (g)” + tab + “Moist (%)” + delimiter

■ Intermediate measurement output format

tab + “XXX.X” (5-byte measuring time) + tab + “XXX” (3-byte sample pan temperature) + tab +
 “XXX.XXXX” (8-byte sample weight) + tab + Moisture content “XXX.XX” (6-byte moisture content)
 + delimiter

■ Final measurement output format

“*” + tab + “XXX.X” (5-byte measuring time) + tab + “XXX” (3-byte sample pan temperature) + tab
 + “XXX.XXXX” (8-byte sample weight) + tab + Moisture content “XXX.XX” (6-byte moisture con-
 tent) + delimiter

16. Maintenance

16-1 Performing Maintenance



Turn the power off and disconnect the power cable. Allow the heater and other parts cool down to ambient temperature before performing maintenance.

Removing and reinstalling parts and components

Remove the sample pan, then the sample pan handler, sample pan supporter, and wind shield in this order.

See “6. Assembly and Installation of Main Unit” on p. 9 for instructions on how to install parts and components.

(1) Wipe away any dust or residue of spilled samples.

(2) Maintenance of the main unit

- Use a soft, dry cloth to wipe away any dirt or soil.
- Avoid applying strong pressure when wiping even if you find dirt or soiling difficult to remove.
- If you find it particularly difficult to remove dirt or soiling, wet a cloth in water or in water with a small amount of neutral detergent, wring the cloth thoroughly, and wipe. Next, rinse the cloth in water and wring it out to remove any detergent and wipe again and then allow to dry.

(3) Maintenance of parts and accessories

- Remove the spoon, spatula, sample pan, and wind shield from the main unit and wash in water with a soft sponge.
- Reattach to the main unit and wait until they completely dry before using the unit again.



* When using detergents, be sure to follow the instructions for use provided with the detergent.



* Never use paint thinner, benzene, or any volatile cleaning agents or any abrasive cleansers or polishes.



* Never use wire brushes or other hard cleaning tools.

16-2 Replacing Fuses

- ① Turn the power off and disconnect the power cord from the unit.
 - ② The fuse holder is located at the rear of the unit. Insert a slot screwdriver or similar tool from the top of the fuse holder and pull the fuse holder towards you.
 - ③ Remove the fuses from the fuse holder and check if any are burned out.
 - ④ If there are no burned-out fuses, return the fuse holder to its original position. Replace burned-out fuse(s) with spare fuse(s) (8A).
 - ⑤ Return the fuse holder to its original position in the main unit.
 - ⑥ Insert the power cord back into the main unit.
- * **Should the fuse(s) blow out repeatedly after replacement, contact your Shimadzu representative.**

17. Parts List

Standard Accessories

Item	Part number	Description
Sample Pan	321-63314	
Sample Pan Handler	321-63315	
Wind Shield	321-63316	
Sample Pan Supporter	321-63317	
Spoon Spatula Set	321-63318	
Fuse, 8A, 2 pcs Set	321-63319	Rated 8A/250V
Aluminum Foil Sheet 10 pcs Set		See below for order
Protection Cover		See below for order

Optional Accessories and Consumables List

Item	Part number	Description
Electronic Printer (W/O AC Adapter)	321-64125	AC Adapter should be separately ordered. Connection cable and Thermal Printer Paper 1 roll are included.
AC Adapter 120V	321-63306-05	For Electronic Printer.
AC Adapter 230V	321-63306-04	For Electronic Printer.
Thermal Printer Paper (10 roll set)	321-63306-08	
RS-232C Cable	321-63308	
Temperature calibration kit	321-64130	
Aluminum Foil Sheet 500 pcs set	321-63320-02	
Protection Cover 5 pcs set	321-64193	

● Specifications of Printer cable and RS-232C communication cable

《Printer cable》 P/N:321-63307

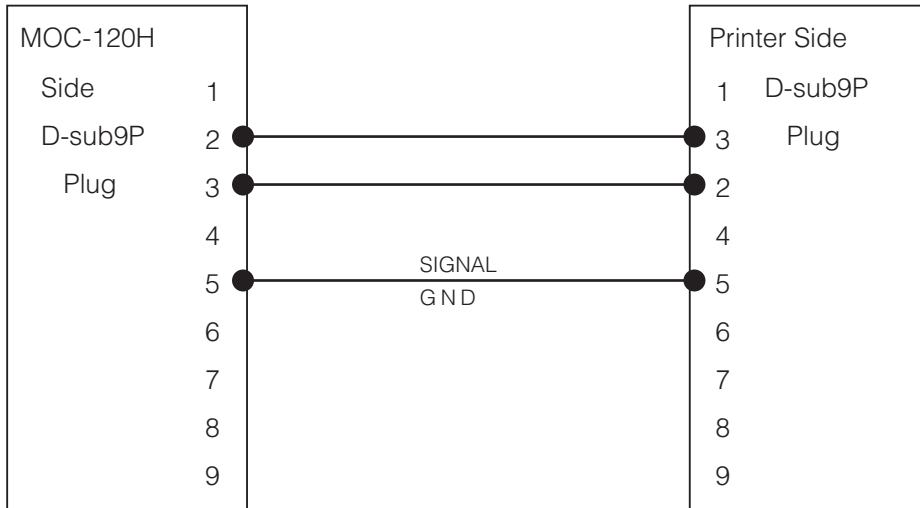

《RS-232C Cable》 P/N:321-63308

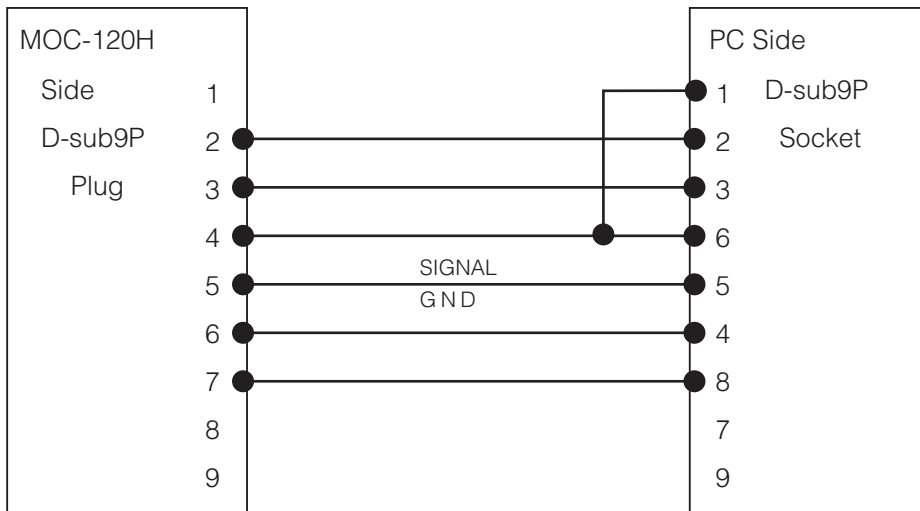

 **SHIMADZU CORPORATION****TOKYO OFFICE**

3, Kanda-Nishikicho 1-chome, Chiyoda-ku, Tokyo 101-8448, Japan
Phone: 81(3)3219-5641 Fax: 81(3)3219-5710
Cable Add.:SHIMADZU TOKYO
Overseas Telex No.: 0232-3291 (SHMDT J)

KYOTO OFFICE

1, Nishinokyo-Kuwabaracho, Nakagyo-ku, Kyoto 604-8511 Japan
Phone: 81(75)823-1200 Fax: 81(75)812-3438
Cable Add.:SHIMADZU KYOTO
Overseas Telex No.: 05422-166 (SHMDS J)

SHIMADZU(CHINA)Co.,LTD. PUXI BRANCH

Block E, No. 570 West Huaihai Road, Shanghai, 200052 P. R. China
Phone: 86(21)2201-3888 Fax: 86(21)2201-3666

SHIMADZU SCIENTIFIC INSTRUMENTS INC

7102, Riverwood Drive, Columbia, Maryland 21046, USA
Phone: 1(410)381-1227 Fax: 1(410)381-1222

SHIMADZU EUROPA GmbH

Albert-Halm-Strasse 6-10, D-47269 Duisburg, F. R. Germany
Phone: 49(203)7687-0 Fax: 49(203)7666-25

SHIMADZU MIDDLE EAST & AFRICA FZE UAE HEAD OFFICE

Warehouse No. RA08UC02, Jebel Ali, Dubai, P.O. Box 262081 United Arab Emirates
Phone: 971(4)883-6668 Fax: 971(4)883-6808

SHIMADZU MIDDLE EAST & AFRICA FZE ISTANBUL BRANCH

Kosuyolu Mah., Salih Omurtak Cad., No:57
34718, Kadikoy Istanbul, Turkey
Phone: 90(216)545-8940 Fax: 90(216)545-8941

SHIMADZU (ASIA PACIFIC) PTE LTD.

79 Science Park Drive #02-01/08, Cintech IV Singapore Science Park 1 Singapore 118264
Phone: (65)6778-6280 Fax: (65)6779-2935

SHIMADZU DO BRASIL COMERCIO LTDA.

Avenida Marques de Sao Vicente, 1771-Barra Funda,
CEP 01139-003, Sao Paulo, SP, Brazil
Phone: 55(11)2134-1688 Fax: 55(11)3611-1635

SHIMADZU SCIENTIFIC INSTRUMENTS (OCEANIA) PTY. LTD.

Unit F, 10-16 South Street Rydalmere N.S.W, 2116
Phone: 61(2)9684-4200 Fax: 61(2)9684-4055