

1 YEAR CE
WARRANTY
MADE IN TAIWAN

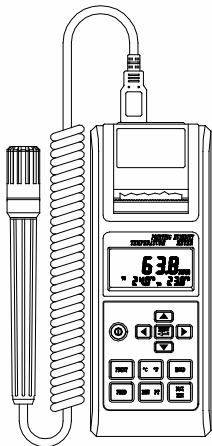

User's Guide

Shop online at

omega.com®
CEOMEGA®

omega.com
e-mail: info@omega.com
For latest product manuals:
omegamanual.info



RH1362P

Printing Humidity / Temperature Meter

M4925/0510

omega.com®
CEOMEGA®

OMEGAnet® Online Service
omega.com

Internet e-mail
info@omega.com

Servicing North America:

U.S.A.:
ISO 9001 Certified

Omega Engineering, Inc., One Omega Drive, P.O. Box 4047
Stamford, CT 06907-0047 USA

Toll Free: 1-800-826-6342
FAX: (203) 359-7700

TEL: (203) 359-1660
e-mail: info@omega.com

Canada:

976 Bergar
Laval (Quebec), Canada H7L 5A1
Toll-Free: 1-800-826-6342
FAX: (514) 856-6886

TEL: (514) 856-6928
e-mail: info@omega.ca

For immediate technical or application assistance:

U.S.A. and Canada:

Sales Service: 1-800-826-6342/1-800-TC-OMEGA®
Customer Service: 1-800-622-2378/1-800-622-BEST®
Engineering Service: 1-800-942-9436/1-800-USA-WHEN®

Mexico:

En Español: 001 (203) 359-7803
info@omega.com.mx

FAX: (001) 203-359-7807
e-mail: espanol@omega.com

Servicing Europe:

Benelux:

Managed by the United Kingdom Office
Toll-Free: 0800 099 3344
FAX: +31 20 643 46 43

TEL: +31 20 347 21 21
e-mail: sales@omega.nl

Czech Republic:

Frystatska 184
733 01 Karviná, Czech Republic
Toll-Free: 0800-1-66342
FAX: +420-59-6311114

TEL: +420-59-6311899
e-mail: info@omegashop.cz

France:

Managed by the United Kingdom Office
Toll-Free: 0800 466 342
FAX: +33 (0) 130 57 54 27

TEL: +33 (0) 161 37 29 00
e-mail: sales@omega.fr

Germany/Austria:

D-75392 Deckenpfronn, Germany
Toll-Free: 0 800 6397678
FAX: +49 (0) 7056 9398-29

TEL: +49 (0) 7059 9398-0
e-mail: info@omega.de

United Kingdom:

ISO 9001 Certified

OMEGA Engineering Ltd.
One Omega Drive, River Bend Technology Centre, Northbank
Irlam, Manchester M44 5BD England
Toll-Free: 0800-488-488
FAX: +44 (0)161 777-6622

TEL: +44 (0)161 777-6611
e-mail: sales@omega.co.uk

It is the policy of OMEGA Engineering, Inc. to comply with all worldwide safety and EMC/EMI regulations that apply. OMEGA is constantly pursuing certification of its products to the European New Approach Directives. OMEGA will add the CE mark to every appropriate device upon certification. The information contained in this document is believed to be correct, but OMEGA accepts no liability for any errors it contains, and reserves the right to alter specifications without notice.
WARNING: These products are not designed for use in, and should not be used for, human applications.

I. SAFETY INFORMATION

- ❑ Read the following safety information carefully before attempting to operate or service the meter.
- ❑ Use the meter only as specified in this manual; otherwise, the protection provided by the meter may be impaired.
- ❑ Caution when working with voltages above 60VDC or 24VAC RMS. Such voltages pose a shock hazard.

Environment conditions

- ① Altitude up to 2000 meters
- ② Indoor use only
- ③ Relatively humidity 95% max.
- ④ Operation Temperature 0 ~ 50°C (32°F ~ 122°F)

Maintenance & Clearing



- ① Repairs or servicing not covered in this manual should only be performed by qualified personnel.
- ② Periodically wipe the case with a dry cloth. Do not use abrasives or solvents on this instrument.

Safety symbols

 Comply with EMC

II. SPECIFICATIONS

2-1 General Information

Display :	Triple 4 digit LCD.
Over Range Indication :	-  - appears.
Low Battery Indication :	 shows up when the battery's voltage is below the operating voltage.
Sampling Rate :	about 1 time per second
Power Requirement :	6pcs 1.5V size AAA alkaline batteries or 9V AC Adaptor /500mA minimum.
Battery Life :	Approx. 90 hours. (interval printing = 60 minutes, excluding beeper). 100 hours (without printing & beeper).
Printing Interval :	6 sec to 59 min 59 sec
Operating Temperature and Humidity :	0°C to 50°C (32°F to 122°F) below 95% RH
Storage Temperature and Humidity :	-10°C to 60°C (14°F to 140°F) below 70% RH
Dimensions (Meter) :	193 (L) × 74 (W) × 37(H) mm
(Probe) :	160 (L) × 13 (D) mm /1m cable
Weight :	Approx. 430g with batteries & thermo-paper.
Accessories :	Carrying case, Instruction manual, Batteries, 2 Rolls of thermo-paper, type K probe.
Printer :	Thermo-printing type with 16 characters per line using 38mm width plain thermo-paper.

2-2 Electrical Specifications

Humidity :

Range : 10%RH to 95%RH

Resolution : 0.1%RH

Accuracy : $\pm 3\%$ RH from 30%RH to 95%RH
 $\pm 5\%$ RH from 10%RH to 30%RH

Temperature (T1) :

Range : -20°C to $+60^{\circ}\text{C}$ (-4°F to $+140^{\circ}\text{F}$)

Resolution : 0.1°C / 0.1°F

Accuracy : $\pm 0.8^{\circ}\text{C}$, $\pm 1.5^{\circ}\text{F}$

Dew Point :

Range : -44.0°C ~ 58.5°C (-47.2°F ~ 137.3°F)

Accuracy : $1.0^{\circ}\text{C}/1.8^{\circ}\text{F}$

Temperature (T2) :

Range : -200°C to $+1333^{\circ}\text{C}$ (-328°F to $+2431^{\circ}\text{F}$)

Resolution : 0.1°C form -200°C to 999°C

0.1°F from -328°F to 999.9°F , other is 1°C , 1°F

Accuracy : -50°C ~ -200°C : $\pm(0.2\% \text{rdg} + 1.8^{\circ}\text{C})$

-50°C ~ 500°C : $\pm(0.1\% \text{rdg} + 0.8^{\circ}\text{C})$

500°C ~ 1333°C : $\pm(0.2\% \text{rdg} + 1.8^{\circ}\text{C})$

-58°F ~ -328°F : $\pm(0.2\% \text{rdg} + 3^{\circ}\text{F})$

-58°F ~ 1000°F : $\pm(0.1\% \text{rdg} + 1.6^{\circ}\text{F})$

1000°F ~ 2431°F : $\pm(0.2\% \text{rdg} + 3^{\circ}\text{F})$

Temperature Coefficient :

0.1 times the applicable accuracy specification per $^{\circ}\text{C}$ from 0°C
to 18°C and 28°C to 50°C (32°F to 64°F and 82°F to 122°F)

III. NAME OF PARTS AND POSITION

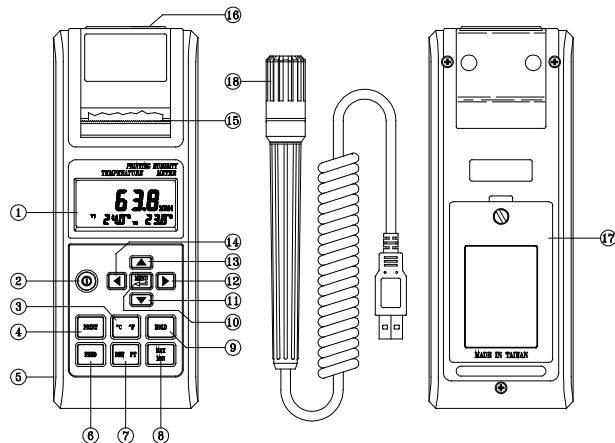





Fig-1

1. LCD : Measured values, unit ,symbols, and decimal points are displayed.
2.  : Key for power on/off
3.  : Key for exchanging temperature unit $^{\circ}\text{C}$ and $^{\circ}\text{F}$.
4.  :
 - ① Key for start printing current data. The format as below:

LINE 1	20 : 12 : 01	02 - 21
LINE 2		58.9 % RH
LINE 3	td	15.7 $^{\circ}\text{C}$
LINE 4	T1	24.3 $^{\circ}\text{C}$
LINE 5	T2	24.8 $^{\circ}\text{C}$

Line 1 : printing time hour: minute: second, month- day.
 Line 2 : printing humidity value.
 Line 3 : printing Dew point value.
 Line 4 : printing T1 temperature value.
 Line 5 : printing T2 temperature value (K-Type).

② Press this button for 2 seconds, the printer will enter interval printing status, and won't stop unless this button is pressed again or FEED button is pressed.

5. DC 9V AC adaptor input jack. 

6. **FEED** PAPER (Fig-2) :

① Key for moving forward thermo-paper one line.
 ② Perform force stop printing, and skip any printing data.

7. **DEW-POINT**: Key for changing humidity to dew-point display.

8. **MAX / MIN** :

① Press this key one time to enter maximum /minimum record mode, the "REC" symbol is displayed.
 ② Press this key to display the maximum reading ("MAX REC" symbol displayed), the minimum reading ("MIN REC" symbol displayed) and the current reading ("REC" symbol displayed) in cycle.
 ③ Press this key 2 seconds to exit this mode.

Fig-2 →



9. **HOLD** : Key for holding the display reading and press again to exit.

10. **MENU** : Key for start/stop set-up parameters mode.

Parameters (in sequence):





ON/OFF (interval printing enable or disable).

TIME INTV (printing interval ranging from 00m:06s to 59m:59s).

INTV▶ (Interval printing start time ranging from 00h:00m to 23h:59m).

INTV■ (Interval printing stop time ranging from 00h:00m to 23h:59m).

TIME (Calendar setting year, month, day, hour, minute).

11.  DOWN : Key for decreasing the value of parameters.
12.  RIGHT : Key for moving to the desired next parameter setting.
13.  UP : Key for increasing the value of parameters setting.
14.  LEFT : Key for moving to the desired forward parameter setting.
15. Way out for thermo-paper.
16. Type K temperature probe jack.
17. Battery cabinet and cover :
6 pcs 1.5V size AAA alkaline batteries.
18. Humidity (including temperature) probe.

LCD DISPLAY :

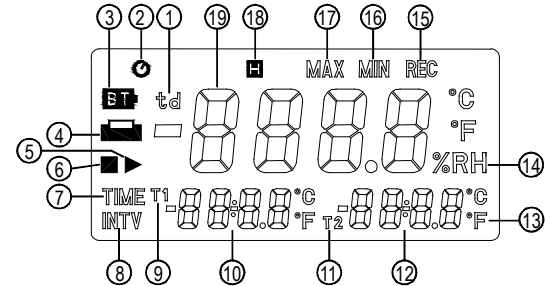

Fig-3

1. Dew point measurement indicator.
2. Preset interval printing function ON indicator.
3. Low battery indicator
4. Printing indicator.
5. Interval printing start time setting indicator.
6. Interval printing stop time setting indicator.
7. Calendar time indicator.

8. Interval printing time indicator.
9. T1 measurement indicator.
10. T1 measured value (NTC).
11. T2 measurement indicator.
12. T2 measured value (Type K).
13. Temperature measurement units.
14. Humidity measurement unit.
15. Recording indicator.
16. Minimum measurement value indicator.
17. Maximum measurement value indicator.
18. Data hold indicator.
19. Humidity and dew point temperature measured value.

IV. PRECAUTIONS AND PREPARATIONS FOR MEASUREMENT

1. Before operating this instrument, please examine it to make sure no shipping damage occurred.
2. Save all packing materials until you are sure that this unit can normally operate.
3. Be sure the batteries are correctly placed in the case or the 9V adaptor is in correct connection.
4. An unsecured battery cover will cause error measuring.
5. To avoid battery leakage problem, remove batteries if this meter will not be used for a long time.
6. Do not use or store this meter outside the operating / storage environment.

V. OPERATING PROCEDURE

1. This meter can be supplied with batteries or DC 9V AC adaptor. If using batteries :

Remove the rear cover, and install batteries. Pay attention to the polarity of battery socket. If using 9V adaptor, make sure there is a good connection to the adaptor socket of the meter. Choose the K-type temperature probe for your application and insert it into T2 the temperature probe socket. Insert Humidity/Temperature (T1) probe into T1 the meter socket.

2. Press the **ⓘ** button to power on the meter, the current date and time will be displayed in about 3 seconds. If “- - -” appears, it indicates no probe or the probe is broken.
3. T1 indicates room temperature, T2 indicates K-type thermocouple test value.
4. Printing data :

- ① Press **PRINT** one time to print one set data.
- ② If continuous printing is required, press and hold down **PRINT** button, until LCD display “INTV” mark and enter continuous interval printing mode, the printer will print data, as follows :

INTV 00 : 06 → Interval printing time, minute : second.

10 : 55 : 19 08-16 → Printing time, hour:minute:second, month:day

 62.7 %RH → Humidity test value and unit.

td 19.8 °C → Dew point and unit.

T1 27.6 °C → Room temperature test value and unit.

T2 26.5 °C → Room temperature test value and unit.

10 : 55 : 25 08-16

 62.7 %RH

td 19.8 °C

T1 27.6 °C

T2 26.5 °C

10 : 55 : 31 08-16
 62.7 %RH
 td 19.8 °C
 T1 27.6 °C
 T2 26.5 °C

10 : 55 : 37 08-16
 62.7 %RH
 td 19.8 °C
 T1 27.6 °C
 T2 26.5 °C

Press **PRINT** or **FEED** key to exit printing mode.





③ When the meter is powered on, if the printing function setting is “ON”, and now time is interval printing start time, the meter will enter to continuous interval printing mode and start printing.

※ Press **PRINT** or **FEED** key to exit printing mode.

※ The interval printing function works only when the start printing time is earlier than the stop printing time, and interval print time can not be longer than 24 hours.

Caution : Before printing, please check thermo-paper is not clipped by thermo-paper cover, if anything interrupts the printer, the meter will shut off the printer power, and “” symbol flickers.

VI. SETTING MODE

Press “” button to enter setting function, re-press this button will select setting parameters in circle (printer on or off, interval printing time, start printing time, stop printing time and calendar setting). The modifier parameter will flicker until the setting is finished. Press  or  button to select parameter setting, press  or  button to increase or decrease the parameter.

Parameter setting in sequence and LCD display as follows :

1. Printing function ON or OFF select.



fig-4

2. Interval printing “second” parameter setting.



fig-5

3. Interval printing “minute” parameter setting.



fig-6

4. Printing start time “minute” parameter setting.



fig-7

5. Printing start time “hour” parameter setting.



fig-8

6. Printing stop time “minute” parameter setting.



fig-9

7. Printing stop time “hour” parameter setting.

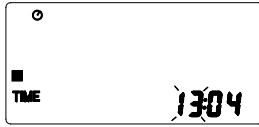

fig-10

8. Calendar “minute” parameter setting.



fig-11

9. Calendar “hour” parameter setting.



fig -12

10. Calendar “day” parameter setting.



fig -13

11. Calendar “month” parameter setting.



fig -14



12. Calendar year last two digit parameter setting.



fig -15





When you finish the setting, press “” key to get back to the measurement mode.

VII. HOW TO SETUP INTERVAL PRINT

- Setup interval print with 24 hours limitation.
 1. Press  key to enter setting mode, setting print operation is ON.
 2. Select interval printing time setting mode, set “second”, “minute” (from 00 : 06 to 59 : 59).
 3. Select start printing time setting mode, set “minute”, “hour” (from 00 : 00 to 23 : 59).
 4. Select stop printing time setting mode, set “minute”, “hour” (from 00 : 00 to 23 : 59).
 5. When you finish the setting, press  key to exit the setting mode, LCD will display “⌚” mark at left upper corner.

Note : The start time must be earlier than the stop time, otherwise the buzzer will beep warning that the setting is in error and did not accept the setting. If this occurs, press  key.

VIII. USER FRIENDLY CALIBRATION PROCEDURE

- Use standard humidity meter to verify the reading.
 1. Press and hold down  key, the press “” key turn on the meter until the LCD show the “SET %RH” symbol.
 2. Press “” and “” keys until the LCD value is same as the standard humidity meter.
 3. Press “” key to store the calibrated value.

IX. BATTERY REPLACEMENT

1. When battery power is not sufficient, **BT** will be shown on LCD. Replace with 6 pcs new of 1.5V size AAA batteries.
2. After the temperature probe is disconnected and the meter is powered off, remove the battery cover.
3. Remove batteries from the holder and replace them with 6 pcs of new 1.5V size AAA alkaline batteries.
4. Secure the battery cover.

WARRANTY/DISCLAIMER

OMEGA ENGINEERING, INC. warrants this unit to be free of defects in materials and workmanship for a period of **13 months** from date of purchase. OMEGA's WARRANTY adds an additional one (1) month grace period to the normal **one (1) year product warranty** to cover handling and shipping time. This ensures that OMEGA's customers receive maximum coverage on each product.

If the unit malfunctions, it must be returned to the factory for evaluation. OMEGA's Customer Service Department will issue an Authorized Return (AR) number immediately upon phone or written request. Upon examination by OMEGA, if the unit is found to be defective, it will be repaired or replaced at no charge. OMEGA's WARRANTY does not apply to defects resulting from any action of the purchaser, including but not limited to mishandling, improper interfacing, operation outside of design limits, improper repair, or unauthorized modification. This WARRANTY is VOID if the unit shows evidence of having been tampered with or shows evidence of having been damaged as a result of excessive corrosion; or current, heat, moisture or vibration; improper specification; misapplication; misuse or other operating conditions outside of OMEGA's control. Components in which wear is not warranted, include but are not limited to contact points, fuses, and triacs.

OMEGA is pleased to offer suggestions on the use of its various products. However, OMEGA neither assumes responsibility for any omissions or errors nor assumes liability for any damages that result from the use of its products in accordance with information provided by OMEGA, either verbal or written. OMEGA warrants only that the parts manufactured by the company will be as specified and free of defects. OMEGA MAKES NO OTHER WARRANTIES OR REPRESENTATIONS OF ANY KIND WHATSOEVER, EXPRESSED OR IMPLIED, EXCEPT THAT OF TITLE, AND ALL IMPLIED WARRANTIES INCLUDING ANY WARRANTY OF MERCHANTABILITY AND FITNESS FOR A PARTICULAR PURPOSE ARE HEREBY DISCLAIMED. LIMITATION OF LIABILITY: The remedies of purchaser set forth herein are exclusive, and the total liability of OMEGA with respect to this order, whether based on contract, warranty, negligence, indemnification, strict liability or otherwise, shall not exceed the purchase price of the component upon which liability is based. In no event shall OMEGA be liable for consequential, incidental or special damages.

CONDITIONS: Equipment sold by OMEGA is not intended to be used, nor shall it be used: (1) as a "Basic Component" under 10 CFR 21 (NRC), used in or with any nuclear installation or activity; or (2) in medical applications or used on humans. Should any Product(s) be used in or with any nuclear installation or activity, medical application, used on humans, or misused in any way, OMEGA assumes no responsibility as set forth in our basic WARRANTY/DISCLAIMER language, and, additionally, purchaser will indemnify OMEGA and hold OMEGA harmless from any liability or damage whatsoever arising out of the use of the Product(s) in such a manner.

RETURN REQUESTS/INQUIRIES

Direct all warranty and repair requests/inquiries to the OMEGA Customer Service Department. BEFORE RETURNING ANY PRODUCT(S) TO OMEGA, PURCHASER MUST OBTAIN AN AUTHORIZED RETURN (AR) NUMBER FROM OMEGA'S CUSTOMER SERVICE DEPARTMENT (IN ORDER TO AVOID PROCESSING DELAYS). The assigned AR number should then be marked on the outside of the return package and on any correspondence.

The purchaser is responsible for shipping charges, freight, insurance and proper packaging to prevent breakage in transit.

FOR **WARRANTY** RETURNS, please have the following information available BEFORE contacting OMEGA:

1. Purchase Order number under which the product was PURCHASED,
2. Model and serial number of the product under warranty, and
3. Repair instructions and/or specific problems relative to the product.

FOR **NON-WARRANTY** REPAIRS, consult OMEGA for current repair charges. Have the following information available BEFORE contacting OMEGA:

1. Purchase Order number to cover the COST of the repair,
2. Model and serial number of the product, and
3. Repair instructions and/or specific problems relative to the product.

OMEGA's policy is to make running changes, not model changes, whenever an improvement is possible. This affords our customers the latest in technology and engineering.

OMEGA is a registered trademark of OMEGA ENGINEERING, INC.

© Copyright 2009 OMEGA ENGINEERING, INC. All rights reserved. This document may not be copied, photocopied, reproduced, translated, or reduced to any electronic medium or machine-readable form, in whole or in part, without the prior written consent of OMEGA ENGINEERING, INC.

Where Do I Find Everything I Need for Process Measurement and Control? OMEGA...Of Course!

Shop online at omega.com SM

TEMPERATURE

- ✓ Thermocouple, RTD & Thermistor Probes, Connectors, Panels & Assemblies
- ✓ Wire: Thermocouple, RTD & Thermistor
- ✓ Calibrators & Ice Point References
- ✓ Recorders, Controllers & Process Monitors
- ✓ Infrared Pyrometers

PRESSURE, STRAIN AND FORCE

- ✓ Transducers & Strain Gages
- ✓ Load Cells & Pressure Gages
- ✓ Displacement Transducers
- ✓ Instrumentation & Accessories

FLOW/LEVEL

- ✓ Rotameters, Gas Mass Flowmeters & Flow Computers
- ✓ Air Velocity Indicators
- ✓ Turbine/Paddlewheel Systems
- ✓ Totalizers & Batch Controllers

pH/CONDUCTIVITY

- ✓ pH Electrodes, Testers & Accessories
- ✓ Benchtop/Laboratory Meters
- ✓ Controllers, Calibrators, Simulators & Pumps
- ✓ Industrial pH & Conductivity Equipment

DATA ACQUISITION

- ✓ Data Acquisition & Engineering Software
- ✓ Communications-Based Acquisition Systems
- ✓ Plug-in Cards for Apple, IBM & Compatibles
- ✓ Data Logging Systems
- ✓ Recorders, Printers & Plotters

HEATERS

- ✓ Heating Cable
- ✓ Cartridge & Strip Heaters
- ✓ Immersion & Band Heaters
- ✓ Flexible Heaters
- ✓ Laboratory Heaters

ENVIRONMENTAL MONITORING AND CONTROL

- ✓ Metering & Control Instrumentation
- ✓ Refractometers
- ✓ Pumps & Tubing
- ✓ Air, Soil & Water Monitors
- ✓ Industrial Water & Wastewater Treatment
- ✓ pH, Conductivity & Dissolved Oxygen Instruments