

HI99131

Waterproof
pH & Temperature Meter
for Plating Baths



INSTRUCTION MANUAL

**Dear
Customer,**

Thank you for choosing a Hanna Instruments product. Please read this instruction manual carefully before using this meter.

This manual will provide you with the necessary information for correct use of this meter, as well as a precise idea of its versatility.

If you need additional technical information, do not hesitate to e-mail us at tech@hannainst.com or view our worldwide contact list at www.hannainst.com.

All rights are reserved. Reproduction in whole or in part is prohibited without the written consent of the copyright owner, Hanna Instruments Inc., Woonsocket, Rhode Island, 02895, USA.

Preliminary examination	4
General description and Intended use	5
Main features.....	6
Specifications.....	7
Display description	8
Operational guide.....	9
Meter setup.....	14
Battery replacement.....	15
Accessories.....	16
Electrode maintenance.....	17
Certification.....	18
Recommendations for users.....	19
Warranty	19

PRELIMINARY EXAMINATION

Remove the instrument and accessories from the packaging and examine it carefully to make sure that no damage has occurred during shipping. Notify your nearest Hanna Instruments Customer Service Center if damage is observed.

Each [HI99131](#) is delivered in a rugged carrying case and is supplied with:

- [HI629113](#) pH/temperature probe with titanium body, DIN connector and 1m (3.3') cable
- [HI70004](#) pH 4.01 buffer (1 sachet)
- [HI70007](#) pH 7.01 buffer (1 sachet)
- [HI700601](#) pH and ORP electrode cleaning solution (2 sachets)
- 100 mL beaker (1 pc.)
- 1.5V AAA alkaline batteries
- Instrument quality certificate
- Electrode quality certificate
- Instruction manual

Note: Save all packing material until you are sure that the instrument works correctly. Any damaged or defective item must be returned in its original packing material with the supplied accessories.

GENERAL DESCRIPTION AND INTENDED USE

The [HI99131](#) portable pH meter together with [HI629113](#) pH electrode is designed to measure pH in plating baths.

The [HI99131](#) is a lightweight, portable pH and temperature meter. It features a two button operation system and is simple to use. It has a waterproof and compact casing, large dual-line display, and automatic pH calibration at one or two points.

The titanium body of the [HI629113](#) functions as a potential matching pin for increased stability of readings and extended sensor life. It also provides an unbreakable structure and allows the transfer of heat to the internal temperature sensor for rapid temperature compensation. The [HI629113](#) has an integrated preamplifier to provide measurements impervious to noise and electrical interferences.

MAIN FEATURES

- Simultaneous pH and temperature measurements on a large dual-line LCD display
- Automatic pH calibration at one or two points within two memorized buffer sets (standard or NIST)
- Selectable temperature unit ($^{\circ}\text{C}$ or $^{\circ}\text{F}$)
- Electrode condition indicator
- mV of pH measurement for electrode check
- **HI629113** dedicated pH probe with integrated temperature sensor
- Probe quick connect system
- Battery life indication and low battery detection
- Keystroke confirmation tone
- Auto-off function
- Waterproof casing IP67

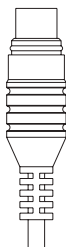
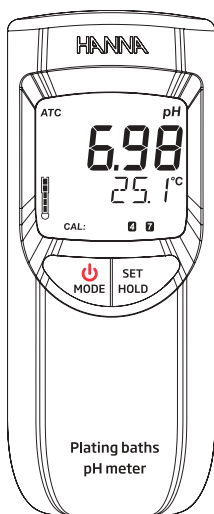

SPECIFICATIONS

Range*	-2.00 to 16.00 pH / -2.0 to 16.0 pH ±825 mV (pH-mV) -5.0 to 105.0 °C/23.0 to 221.0 °F
Resolution	0.01 pH / 0.1 pH 1 mV 0.1 °C/0.1 °F
Accuracy @ 25 °C / 77 °F	±0.02 pH / ±0.1 pH ±1 mV (pH-mV) ±0.5 °C up to 60 °C; ±1.0 °C (outside) ±1.0 °F up to 140 °F; ±2.0 °F (outside)
Temperature compensation	Automatic -5.0 to 105.0 °C/23.0 to 221.0 °F
pH calibration	Automatic, 1 or 2 point selectable buffer set Standard (4.01, 7.01, 10.01) or NIST (4.01, 6.86, 9.18)
Probe (included)	HI629113 preamplified pH and temperature probe with titanium body, DIN connector and 1 m (3.3') cable
Battery type/life	1.5V AAA (3 pcs.) approx. 1400 hours of continuous use
Auto-off	user selectable: after 8 min, 60 min or disabled
Environment	0 to 50 °C (32 to 122 °F) RH max. 100%
Meter dimensions	154 x 63 x 30 mm (6.1 x 2.5 x 1.2")
Weight (with batteries)	196 g (6.91 oz.)
Case ingress protection rating	IP67

* the **HI629113** is limited to be used from 0 to 13 pH and from 0 to 80 °C temperature (32 to 176 °F).

DISPLAY DESCRIPTION

DISPLAY DESCRIPTION

- 1 Automatic Temperature Compensation indicator
- 2 Stability indicator
- 3 Battery percentage
- 4 Electrode condition indicator
- 5 Low battery indicator
- 6 Measurement unit
- 7 Primary LCD
- 8 Temperature unit
- 9 Secondary LCD
- 10 Meter modes indicator
- 11 pH calibration buffer(s) used

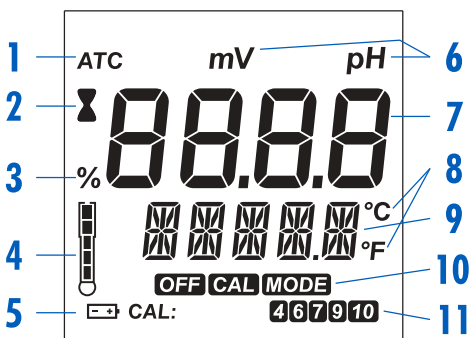

OPERATIONAL GUIDE

Each meter is supplied with batteries. Before using the meter for the first time, open the battery compartment and insert batteries, observing the polarity (see “Battery Replacement”).

CONNECTING THE ELECTRODE

With the meter turned off, connect the HI629113 probe to the DIN socket on the bottom of the meter by aligning the pins and pushing in the plug firmly. Remove the protective cap from the probe before taking any measurements.

TURNING THE METER ON

To turn the meter ON, press the  button on the front of the meter. If it does not turn on, make sure that the batteries are properly installed in their place. The meter is provided with an active acoustic signal when a key is pressed. At start-up the meter displays all LCD segments for a few seconds, followed by the percentage indication of the remaining battery life, displaying “WAIT” until electrode check is in process then the meter enters the normal measurement mode.

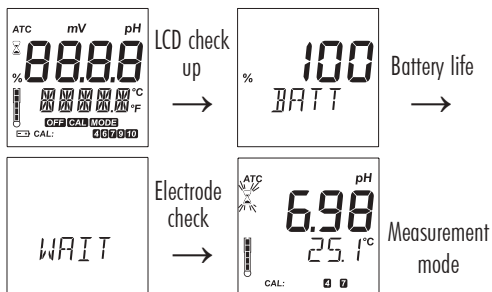

Note: The meter detects the presence and the type of the probe at its input.

- If the probe is not connected the message “NO” “PROBE” appears alternatively on the secondary LCD with “---” blinking on the first LCD line.
- If the probe is not compatible “WRONG” “PROBE” message appears alternatively on the secondary LCD with “---” blinking on the first LCD line.
- If the readings are out of range, the nearest range limits are displayed blinking (e.g. -2.00 pH -5.0 °C).

SELECTING MEASUREMENT RANGE

While in measurement mode, press the **SET** button to select pH or pH-mV measurement on the first LCD line.

FREEZING MEASUREMENT VALUES

While in measurement mode, press and hold the **SET** button until “**HOLD**” appears on the secondary LCD. The “**HOLD**” remains for 1 second and reading of pH, mV and temperature will be frozen on the LCD with “**H**” blinking.

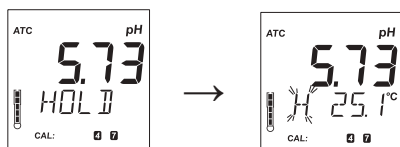

Press any button to resume active measurements.

ENTERING CALIBRATION MODE

Press and hold the  button until “**POWER**” and **OFF** tag is replaced by “**STD**” and **CAL** tag. Release the button.

ENTERING SETUP MODE

Press and hold  button until “**STD**” and **CAL** tag is replaced by “**SETUP**” and **MODE** tag. Release the button.

TURNING THE METER OFF

While in measurement mode, press the  button. “**POWER**” and **OFF** tag will appear. Release the button.

pH MEASUREMENT & CALIBRATION

Make sure the meter has been calibrated before use.

If the probe is dry, soak it in **HI70300** storage solution for 30 minutes to reactivate it. If soiled, clean the electrode by soaking in cleaning solution for 20 minutes, then rinse the tip and soak in storage solution at least 30 minutes before use.

Rinse the electrode off well and shake off excess droplets. Recalibrate before using.

Submerge the probe in the sample to be tested while stirring it gently. Wait until the  tag on the LCD disappears.

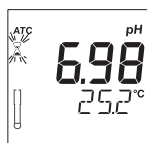

The LCD displays the pH value (automatically compensated for temperature) on the primary LCD, while the secondary LCD displays the sample temperature. If measurements are taken in different samples successively, rinse the probe tip thoroughly in distilled or deionized water to eliminate cross-contamination.

For better accuracy, frequent calibration of the pH sensor with the meter is recommended. In addition, the meter must be recalibrated:

- whenever the pH electrode is replaced.
- after testing aggressive chemicals.
- when high accuracy is required.
- at least once a month.
- after cleaning the sensor.

pH calibration

Enter calibration mode while in pH measurement mode. Place the sensor into the first calibration buffer.

If performing a two-point calibration, use pH 7.01 (pH 6.86 for NIST) buffer first. The meter will enter the calibration mode, displaying "pH 7.01 USE" **CAL** and ⏰ tag blinking (or "pH 6.86 USE" for NIST).

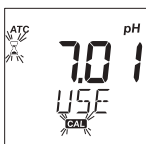

Follow directions for single and two-point calibration below:

Single-point calibration

- Place the probe in any buffer from the selected buffer set. The meter will automatically recognize the buffer value.
- If the buffer is not recognized or the calibration offset is out of the accepted range "---- **WRONG**" is displayed.
- If the buffer is recognized "**REC**" is displayed then "**WAIT**" until the calibration is accepted.

If using pH 7.01 (or pH 6.86 for NIST), after acceptance of the buffer press any key to exit. The "**SAVE**" message is displayed and the meter returns to pH measurement mode. If using pH 4.01 or 10.01 (or pH 9.18 for NIST) buffer the "**SAVE**" message is displayed and the meter returns to pH measurement mode.

Two-point calibration

Proceed with steps 1 through 3 under single-point calibration using 7.01 pH (pH 6.86 for NIST) buffer first. Then follow steps below:

The “**pH 4.01 USE**” message is then displayed.

Place the probe in the second calibration buffer (pH 4.01 or 10.01, or, if using NIST, pH 4.01 or 9.18). When the second buffer is accepted, the LCD will display “**SAVE**” for 1 second and the meter will return to the normal measurement mode.

If the buffer is not recognized or the slope is out of accepted range “--- **WRONG**” is displayed. Change the buffer, clean the electrode or press any key to exit calibration.

For better accuracy it is always recommended to carry out a two-point calibration.

After the calibration procedure has been completed, the **CAL** tag is turned on together with the calibrated points.

Exiting calibration and resetting default values

After entering the calibration mode and before the first point is accepted, it is possible to quit the procedure and return to the last calibration data by pressing the  button. The LCD displays “**ESC**” for 1 second and the meter returns to normal mode.

To reset the default values and clear a previous calibration, press the **SET** button after entering the calibration mode and before the first point is accepted.

The LCD displays “**CLEAR**” for 1 second, the meter resets to the default calibration and the **CAL** tag with the calibrated points on the LCD disappears.

ELECTRODE CONDITION

The display is provided with a probe icon (unless the feature is disabled from setup) which indicates the electrode status after calibration. The “condition” remains active for 12 hours (unless the batteries are removed).

The electrode condition is evaluated only if the current calibration has two points.



With 1 bar it is recommended to clean the electrode and recalibrate. If there is still only 1 bar or 1 bar blinking replace the probe.

Sensor check



Setting the meter to pH-mV range the user can check the sensor status at any time. The offset value is the reading in pH 7.01 buffer (@ 25 °C/77 °F). If this reading is outside the range ± 30 mV, the electrode is considered “very poor”. The slope value of the sensor is the difference between readings in pH 7.01 and in pH 4.01 buffers. When the slope reaches the value of about 150 mV, the electrode is considered “very poor”. When “poor” or “very poor”, it is recommended to replace it with a new one.



Note: To ensure reliable readings, the electrode must be cleaned with cleaning solution and then hydrated in storage solution for a minimum of 30 minutes before calibrating the probe.



METER SETUP



Setup mode allows the selection of the Temperature unit, Auto-off, Beep confirmation tone, the type of pH buffer set, the Resolution and Information. To enter Setup mode press and hold  button until "STD" and **CAL** tag is replaced by "SETUP" and **MODE** tag. Release the button.



- "TEMP" is displayed on the secondary LCD with the current temperature unit (e.g. "TEMP °C"), for °C/°F selection, use the **SET** button. After the temperature unit has been selected, press  to confirm and to enter the "A-OFF" selection.

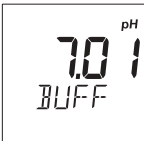

- Use the **SET** button, to navigate through the auto-off choices: 8 minutes ("8", default value), 60 minutes ("60") or disabled ("---"). Press  to confirm and to enter the "BEEP" selection.

- To switch the beep tone ON or OFF, press the **SET** button; press  to confirm and to enter the calibration buffer selection "pH 7.01 BUFF".

- To change the buffer set, the meter will show the current buffer set: "pH 7.01 BUFF" (for standard buffer set: 4.01/7.01/10.01) or "pH 6.86 BUFF" (for NIST buffer set: 4.01/6.86/9.18). Change the set with the **SET** button. Press  to confirm and to enter pH resolution selection "RESOL".



- To change the pH measurement resolution between "0.1" and "0.01" use the **SET** button; then press  to confirm and to enter electrode calibration information "INFO" selection.

- To switch the electrode condition indicator on the LCD ON or OFF, press the **SET** button; press  to exit setup options. Change the set with the **SET** button, then press  to confirm and to return to normal mode.

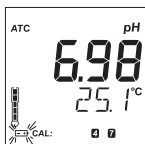

BATTERY REPLACEMENT

When the remaining battery life is less than 10% the battery tag blinks on the display to warn the user.



Battery Error Prevention System (BEPS)

If the battery is too weak ("0%") the display shows "bAtt", "DEAD" for a few seconds then the meter powers off. Immediately replace the batteries with new ones.

The batteries are accessed by opening the battery cover on the back of the instrument. Remove protective boot if present.

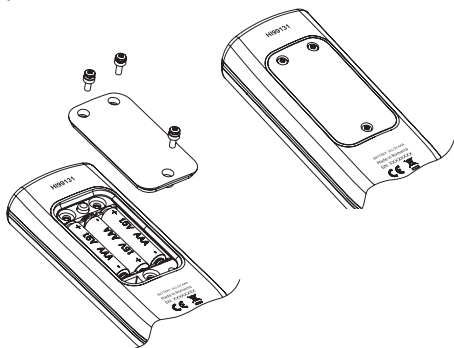

Replace the three 1.5V AAA alkaline batteries located in the battery compartment, observing the indicated polarity.

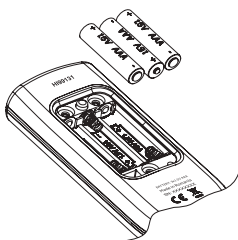

Replace the battery cover making sure that the gasket is in place.

ACCESSORIES

HI629113	Combination preamplified pH/temperature probe with titanium body, DIN connector and 1 m (3.3') cable
HI7004L	pH 4.01 buffer solution, 500 mL
HI7006L	pH 6.86 buffer solution, 500 mL
HI7007L	pH 7.01 buffer solution, 500 mL
HI7009L	pH 9.18 buffer solution, 500 mL
HI7010L	pH 10.01 buffer solution, 500 mL
HI70300L	Storage solution for pH and ORP electrodes, 500 mL
HI700601P	pH and ORP electrode cleaning solution, 20 mL sachet, 25pcs.
HI710028	Orange silicon rubber boot
HI710142	Black carrying case for HI991XX portable instruments
HI77400P	Calibration kit (pH 4.01 and pH 7.01, 20 mL sachets, 5 pcs. each)

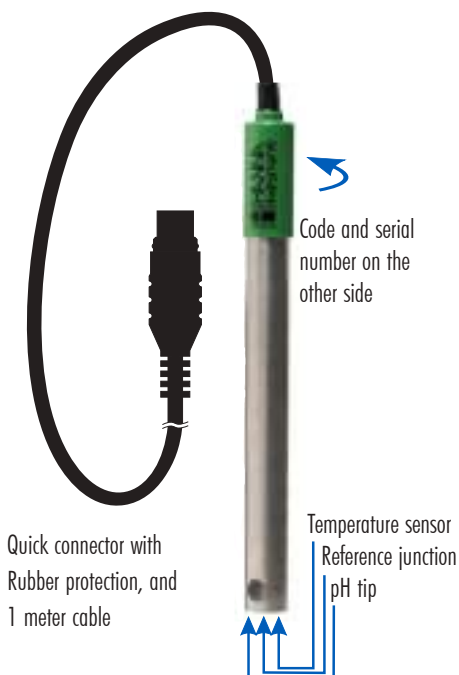

ELECTRODE MAINTENANCE

PREPARATION

- Remove the protective cap. Do not be alarmed if any salt deposits are present. Rinse with water.
- Shake the electrode down as you would do with a clinical thermometer to eliminate any air bubbles inside the glass tip.
- If the glass tip and/or junction are dry, soak the electrode in **HI70300** storage solution for a minimum of 30 minutes.
- Rinse with water.
- Calibrate before using.

STORAGE

- To ensure a quick response, the glass tip and the junction should be kept moist and not allowed to dry.
- Replace protective cap with a few drops of **HI70300** storage solution. Follow PREPARATION above before taking measurements.

Note: Never store the electrode in distilled water.

PERIODIC MAINTENANCE

- Inspect the electrode for any scratches or cracks. If any present, replace the electrode.
- Rinse off any salt deposits with water.
- Follow the STORAGE procedure above.

CLEANING PROCEDURE

- Soak in Hanna **HI700601** pH and ORP electrode cleaning solution for 20 minutes. Rinse with water.
- Soak the electrode in **HI70300** storage solution for a minimum of 30 minutes. Rinse with water. Calibrate before using.

TROUBLESHOOTING

- pH Meter: Follow the meter's operating and calibration procedures.
- Electrode: Evaluate your electrode performance based on the **Sensor check** procedure on page 13.

CERTIFICATION

All Hanna Instruments conform to the **CE European Directives**.



RoHS
compliant

Disposal of Electrical & Electronic Equipment. The product should not be treated as household waste. Instead hand it over to the appropriate collection point for the recycling of electrical and electronic equipment which will conserve natural resources.

Disposal of waste batteries. This product contains batteries, do not dispose of them with other household waste. Hand them over to the appropriate collection point for recycling.

Ensuring proper product and battery disposal prevents potential negative consequences for the environment and human health. For more information, contact your city, your local household waste disposal service, the place of purchase or go to www.hannainst.com.



Recommendations for users

Before using this product, make sure it is entirely suitable for your specific application and for the environment in which it is used. Any variation introduced by the user to the supplied equipment may degrade the meter's performance. For yours and the meter's safety do not use or store the meter in hazardous environments.

Warranty

HI99131 is warranted for two years against defects in workmanship and materials when used for its intended purpose and maintained according to instructions. Electrodes and probes are warranted for a period of six months. This warranty is limited to repair or replacement free of charge. Damage due to accidents, misuse, tampering or lack of prescribed maintenance is not covered.

If service is required, contact your local Hanna Instruments Office. If under warranty, report the model number, date of purchase, serial number (see engraved on the back of the meter) and the nature of the problem. If the repair is not covered by the warranty, you will be notified of the charges incurred. If the meter is to be returned to Hanna Instruments, first obtain a Returned Goods Authorization number from the Technical Service department and then send it with shipping costs prepaid. When shipping any meter, make sure it is properly packed for complete protection.

Hanna Instruments reserves the right to modify the design, construction or appearance of its products without advance notice.

World Headquarters

Hanna Instruments Inc.
Highland Industrial Park
584 Park East Drive
Woonsocket, RI 02895 USA
www.hannainst.com