



S85

LASER distance sensor for precise measurement up to 20 m with a millimeter of resolution and repeatability through the Time of Flight technology

- Time of Flight technology
- Class 2 visible red LASER for an easy alignment with the target
- Measuring range up to 10m or 20m in the advanced model
- 1 mm resolution, 7 mm accuracy, 1 mm repeatability
- 4-20 mA or 0-10 V scalable analog output and 2 digital outputs
- RS485 serial interface in the advanced model
- Standard M12 connector
- IP67 Industrial metal housing

APPLICATIONS

- Automated warehousing
- Processing and Packaging machinery
- Industrial vehicles
- Automotive



SENSORS

S85		
Distance sensor (90% White target)		0,2...20 m (S85...Y13) 0,2...10 m (S85...Y03)
Repeatability		1...2 mm
Accuracy		7...10 mm
Resolution		1 mm
Light emission		red LASER (class 2)
Response time		30 ms (S85...Y03) 15...30 ms (S85...Y13)
Serial interface		RS485 (S85...Y13)
Setting		Display (S85...Y13) push-buttons (S85...Y03)
Power supply	Vdc	24 Vdc +/- 20%
	PNP	▪
Output	NPN	▪
	Push pull	▪
	other	Analog output: 4...20 mA or 0...10 V
Connection	connector	▪
Approximate dimensions (mm)		60x72x37
Housing material		Zamak
Mechanical protection		IP67

TECHNICAL DATA	
Power supply	24 Vdc \pm 20%
Consumption (output current excluded)	2,8 W max. (mod. S85...Y03) 3 W max. (mod. S85...Y13)
Light emission	red Laser 658 nm
Setting	push-buttons (mod. S85...Y03) push-buttons and display (mod. S85...Y13)
Operating distance	90% white target 0,2...10 m (mod. S85...Y03), 0,2...20 m (mod. S85...Y13) 18% grey target 0,2...5 m (mod. S85...Y03), 0,2...8 m (mod. S85...Y13) 6% black target 0,2...3 m (mod. S85...Y03), 0,2...5 m (mod. S85...Y13)
Indicators	yellow Q1 LED, Q2 LED green/red POWER/OUT OF RANGE LED 5-digit multi display (mod. S85...Y13)
Output	push pull/Q (mod. S85...Y03) PNP, NPN, push pull, Q, Qneg (mod. S85...Y13)
Analog output	0-10 V (mod. S85...Y03-00V) 4-20 mA (mod. S85...Y03-00I) 0-10 V/4-20 mA (mod. S85...Y13-00IVY)
Response time	slow 45 ms (mod. S85...Y13) medium 30 ms fast 15 ms (mod. S85...13)
Connection	M12 5-pole connector (mod. S85...Y03), M12 8-pole connector (mod. S85...Y13)
Dielectric strength	500 Vac, 1 min between electronics and housing
Insulating resistance	>20 M Ω , 500 Vdc between electronics and housing
Mechanical protection	IP67
Ambient light rejection	according to EN 60947-5-2, >40 Klux DC ambient light
Vibrations	0,5 mm amplitude, 10 ... 55 Hz frequency, for every axis (EN60068-2-6)
Shock resistance	11 ms (30 G) 6 shock for every axis (EN60068-2-27)
Housing material	ZINC ALLOY ZAMA 13 EN-1774/PC LEXAN 121R display
Lens material	PMMA
Operating temperature	-15 ... 50 °C
Storage temperature	-25 ... 70 °C
Weight	250 g max.

DIMENSIONS

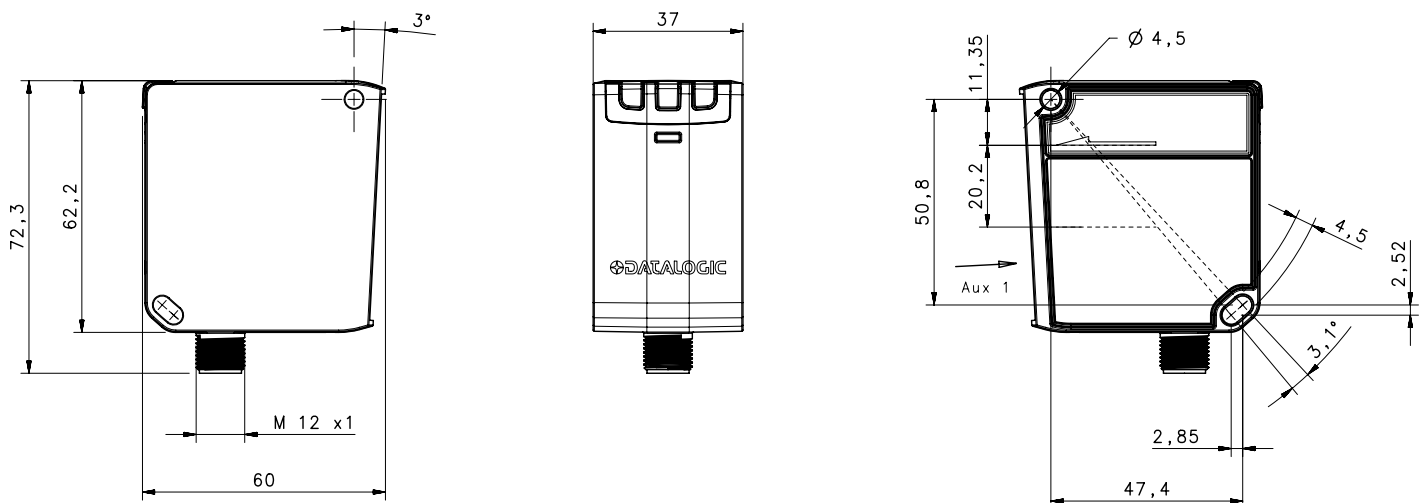

CONNECTIONS

M12 CONNECTOR - STANDARD

S85-Y03-00V
Voltage version

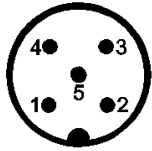

1 (BROWN): +24 V \pm 20 %
2 (WHITE): Q2 100mA max.
3 (BLUE): 0 V
4 (BLACK): Q1 100mA max.
5 (GREY): ANALOG. OUT 0-10V

S85-Y03-00I
Current version

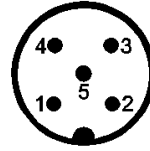

1 (BROWN): +24 V \pm 20 %
2 (WHITE): Q2 100mA max.
3 (BLUE): 0 V
4 (BLACK): Q1 100mA max.
5 (GREY): ANALOG. OUT 4-20mA

M12 CONNECTOR - ADVANCED

S85-Y13-00IVY
Analog version

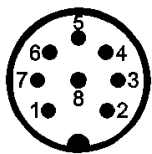

1 (WHITE): RS485 -
2 (BROWN): +24 V \pm 20 %
3 (GREEN): ANALOGUE OUT
4 (YELLOW): Q1 100mA max.
5 (GREY): Q2 100mA max.
6 (PINK): RS485 +
7 (BLUE): 0 V
8 (RED): MULTIFUNC.INPUT

S85-Y13-00Y

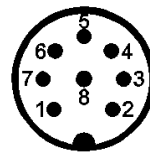

1 (WHITE): RS485 -
2 (BROWN): +24 V \pm 20 %
3 (GREEN): RESERVED
4 (YELLOW): Q1 100mA max.
5 (GREY): Q2 100mA max.
6 (PINK): RS485 +
7 (BLUE): 0 V
8 (RED): MULTIFUNC.INPUT

INDICATORS AND SETTINGS

Without the procedure setting the sensor is configured to measure distances on a white target from a minimum value of 200 mm and a maximum of 20000 mm, with both switching point placed at 500 mm.

The parameters can be changed by the menu on the display pointing the LASER on the target in the different interested points.

INDICATORS

LED 1 | Q1 (yellow)
LED 2 | Q2 (yellow)
LED 3 | POWER ON (green),
OUT OF RANGE (red)



DISPLAY | Run/W.UP → Run mode or Warm-up mode
| Q+Q → Digital Output setting → PNP/NPN/Push-Pull
| I/V → Analog Output Setting → Ampere/Volt
| Lock Symbol → Keylock or unlock
| 5-digit display → Value corresponds to Distance in mm

Menu	Functions
OUT 1	Switching point1: Light/Dark; Switching point value; PNP, NPN, Push-pull; Alarm
OUT 2	Switching point 2: Light/Dark; Switching point value; PNP, NPN, Push-pull; Alarm
HYSTERESIS	Hysteresis level: 5...1000 mm
ANALOG OUT	Voltage (0...10 V); Current (4...20 mA)
MULTIFUNCTION IN	LASER OFF; Teach IN (Thresholds); RS485 Send Data
AVERAGE	Response time: SLOW; MEDIUM; FAST
RS485	Node N°; Enable; Termination; Output mode; Delay (0...254 ms)
SCALABLE OUT	Analog output range: Reset, MIN and MAX distance
FACTORY RESET	Factory default values
INFO	Software version

DETECTION DIAGRAMS

CURRENT ANALOG OUTPUT

MEASUREMENT RANGE (4...20 mA)
OUT OF RANGE (3,95...4 mA; 20...20,5 mA)

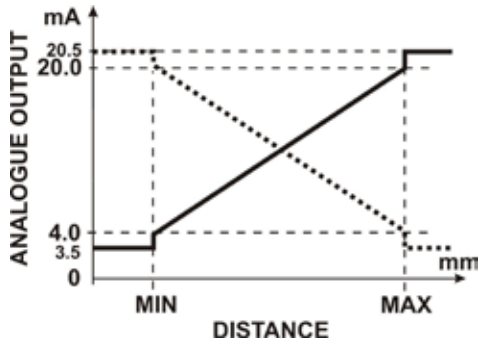

VOLTAGE ANALOG OUTPUT

MEASUREMENT RANGE (0...10 V)

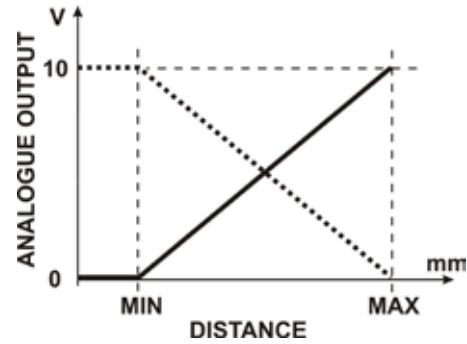

S85-...-Y13 ADVANCED REPEATABILITY (SLOW MODE)

[WHITE 90%; GREY 18%; BLACK 6%]

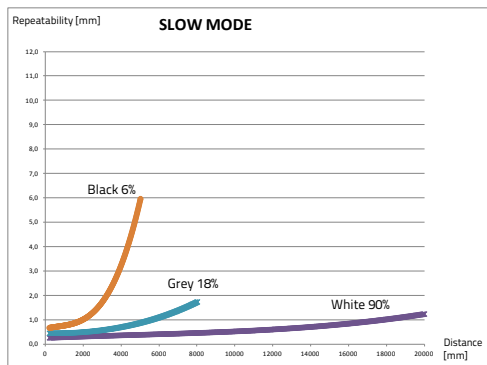

S85-...-Y13 ADVANCED REPEATABILITY (MEDIUM MODE)

[WHITE 90%; GREY 18%; BLACK 6%]

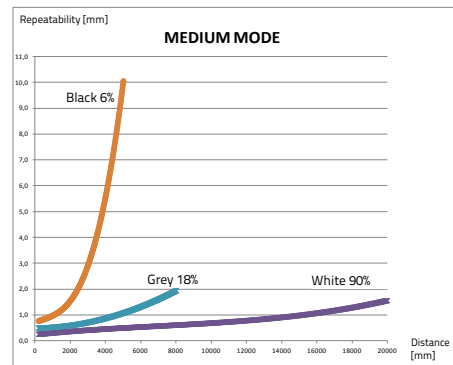

S85-...-Y13 ADVANCED REPEATABILITY (FAST MODE)

[WHITE 90%; GREY 18%; BLACK 6%]

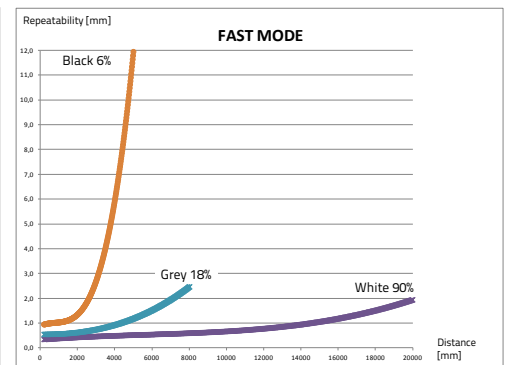

S85-...-Y13 ADVANCED

REPEATABILITY/RESPONSE TIME

(90% WHITE TARGET @ 20 m)

Mode	Response time	Repeatability
Slow	45 ms	< 1,5 mm
Medium	30 ms	1,5 mm
Fast	15 ms	< 2 mm

HYSTERESIS

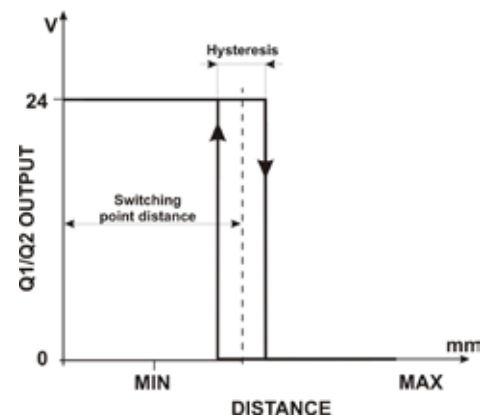

MODEL SELECTION AND ORDER INFORMATION

OPTIC FUNCTION	OPERATING DISTANCE	CONNECTION	OUTPUT & INPUT	MODELS	ORDER No.
Distance sensor (Standard)	10 m	M12 5-pole connector	2 Digital outputs; Analog output: Voltage (0...10 V)	S85-MH-5-Y03-00V	951511010
			2 Digital outputs; Analog output: Current (4...20mA)	S85-MH-5-Y03-00I	951511030
Distance sensor (Advanced)	20 m	M12 8-pole connector	2 Digital outputs; Analog output: Current (4...20mA) or Voltage (0...10 V); RS485; Multifunction input	S85-MH-5-Y13-00IVY	951511020
			2 Digital outputs; RS485; Multifunction input	S85-MH-5-Y13-00Y	951511040

ACCESSORIES

ST-S85-STD

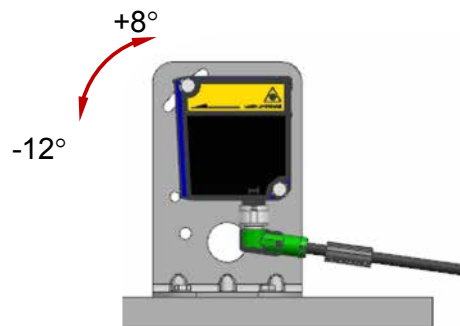
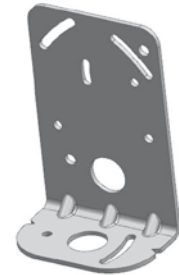
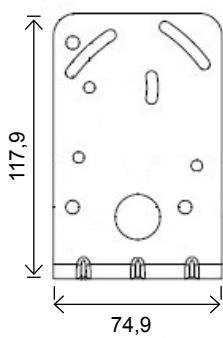

MODEL	DESCRIPTION	ORDER No.
ST-S85-STD	mounting bracket	95ACC7840

CABLES

TYPE	DESCRIPTION	LENGTH	MODEL	ORDER No.
Axial M12 connector	5-pole, grey, P.V.C.	3 m	CS-A1-03-G-03	95ACC2110
		5 m	CS-A1-03-G-05	95ACC2120
		10 m	CS-A1-03-G-10	95ACC2140
	5-pole, U.L., black, P.V.C	3 m	CS-A1-03-U-03	95ASE1170
		5 m	CS-A1-03-U-05	95ASE1180
		10 m	CS-A1-03-U-10	95ASE1190
		15 m	CS-A1-03-U-15	95ASE1200
		25 m	CS-A1-03-U-25	95ASE1210
Axial M12 Connector	8-pole, black, P.V.C.	3 m	CS-A1-06-B-03	95ACC2230
		5 m	CS-A1-06-B-05	95ACC2240
		10 m	CS-A1-06-B-10	95ACC2250
Radial M12 Connector	8-pole, shielded, black, P.V.C.	3 m	CV-A2-26-B-03	95ACC1600
		5 m	CV-A2-26-B-05	95ACC1610
		10 m	CV-A2-26-B-10	95ACC1620
Axial M12 Connector	8-pole, shielded, black, P.V.C.	3 m	CV-A1-26-B-03	95ACC1510
		5 m	CV-A1-26-B-05	95ACC1520
		10 m	CV-A1-26-B-10	95ACC1530
		15 m	CV-A1-26-B-15	95ACC2080
		25 m	CV-A1-26-B-25	95ACC2100
		8-pole, U.L., black, P.V.C.	3 m	CS-A1-06-U-03
	5 m		CS-A1-06-U-05	95ASE1230
	10 m		CS-A1-06-U-10	95ASE1240
	15 m		CS-A1-06-U-15	95ASE1250
	8-pole, black	25 m	CS-A1-06-U-25	95ASE1260
50 m		CS-A1-06-U-50	95A252710	
Connector-not cabled		CS-A1-06-B-NC	95ACC2550	