

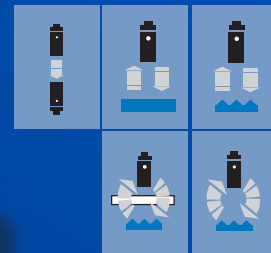

# FA series

M18 photoelectric sensors DC



## features

- Complete range of M18 sensors with 10...30 Vdc power supply
- Axial and radial optic with flat surface
- Retro-reflective models for transparent objects detection, with red emission
- IP67 protection degree
- Metallic or plastic housing
- Sensitivity adjustment available for all models
- Total protection against any type of electric damages
- Approvals: CE and cULus listed



## web contents



- Application notes
- Photos
- Catalogue / Manuals



M18 cylindrical DC

## code description (\*)

	FA	I	C	/	B	P	-	0	A	
series	FA	M18 sensor with 4 DC wires								
emission	I	Infrared invisible led emission								
	R	Red visible led emission								
type	2	100 mm Direct reflection without adjustment								
	3	100 mm Direct reflection with adjustment								
	4	200 mm Direct reflection with adjustment								
	5	200 mm Direct reflection without adjustment								
	6	400 mm Direct reflection without adjustment								
	7	400 mm Direct reflection with adjustment								
	8	Direct reflection: 1000 mm axial, 800 mm radial with adjustment								
	C	Reflex without adjustment								
	P	Reflex polarized without adjustment								
	N	Reflex polarized with adjustment								
	M	Reflex with adjustment								
	L	Reflex with adj. for transparent objects detection								
	H	Emitter								
	emitter	D	Receiver with sensitivity adjustment							
Z		Receiver without sensitivity adjustment								
0		Emitter								
output	X	Emitter with check								
	B	4 wires output complementary NO and NC								
	0	Emitter								
housing	P	PNP output								
	N	NPN output								
	0	Plastic housing, axial optic								
plug / cable output	1	Metal housing, axial optic								
	2	Plastic housing, radial optic								
	3	Metal housing, radial optic								
plug / cable output	A	Axial cable output								
	E	Axial M12 plastic connector output								

(\*) ATEX models available, contact our Sales Dept. for further information.



## available models

### cable exit photoelectric sensors

M18 cylindrical DC

model	distance	housing	adjustment	4 wires (axial optic)		4 wires (right angle optic)	
				NPN NO + NC	PNP NO + NC	NPN NO + NC	PNP NO + NC
diffuse reflection	100 mm	plastic	-	FAR2/BN-0A	FAR2/BP-0A	FAR2/BN-2A	FAR2/BP-2A
			●	FAR3/BN-0A	FAR3/BP-0A	FAR3/BN-2A	FAR3/BP-2A
		metallic	-	FAR2/BN-1A	FAR2/BP-1A	FAR2/BN-3A	FAR2/BP-3A
			●	FAR3/BN-1A	FAR3/BP-1A	FAR3/BN-3A	FAR3/BP-3A
	200 mm	plastic	-	FAI4/BN-0A	FAI4/BP-0A	FAI4/BN-2A	FAI4/BP-2A
			●	FAI5/BN-0A	FAI5/BP-0A	FAI5/BN-2A	FAI5/BP-2A
			-	FAI4/BN-1A	FAI4/BP-1A	FAI4/BN-3A	FAI4/BP-3A
		metallic	●	FAI5/BN-1A	FAI5/BP-1A	FAI5/BN-3A	FAI5/BP-3A
			-	FAI6/BN-0A	FAI6/BP-0A	FAI6/BN-2A	FAI6/BP-2A
			●	FAI7/BN-0A	FAI7/BP-0A	FAI7/BN-2A	FAI7/BP-2A
	400 mm	plastic	-	FAI6/BN-1A	FAI6/BP-1A	FAI6/BN-3A	FAI6/BP-3A
			●	FAI7/BN-1A	FAI7/BP-1A	FAI7/BN-3A	FAI7/BP-3A
		metallic	-	FAI6/BN-0A	FAI6/BP-0A	FAI6/BN-2A	FAI6/BP-2A
			●	FAI7/BN-0A	FAI7/BP-0A	FAI7/BN-2A	FAI7/BP-2A
1,000 mm (axial)	plastic	●	FAI8/BN-0A	FAI8/BP-0A	FAI8/BN-2A	FAI8/BP-2A	
800 mm (90°)	metallic	-	FAI8/BN-1A	FAI8/BP-1A	FAI8/BN-3A	FAI8/BP-3A	
retroreflective	5 m (axial)	plastic	-	FAIC/BN-0A	FAIC/BP-0A	FAIC/BN-2A	FAIC/BP-2A
			●	FAIM/BN-0A	FAIM/BP-0A	FAIM/BN-2A	FAIM/BP-2A
	4 m (90°)	metallic	-	FAIC/BN-1A	FAIC/BP-1A	FAIC/BN-3A	FAIC/BP-3A
			●	FAIM/BN-1A	FAIM/BP-1A	FAIM/BN-3A	FAIM/BP-3A
polarized	4 m (axial)	plastic	-	FARP/BN-0A	FARP/BP-0A	FARP/BN-2A	FARP/BP-2A
			●	FARN/BN-0A	FARN/BP-0A	FARN/BN-2A	FARN/BP-2A
	2.5 m (90°)	metallic	-	FARP/BN-1A	FARP/BP-1A	FARP/BN-3A	FARP/BP-3A
			●	FARN/BN-1A	FARN/BP-1A	FARN/BN-3A	FARN/BP-3A
trasparents	0.1...1.5 m	plastic	●	FARL/BN-0A	FARL/BP-0A	FARL/BN-2A	FARL/BP-2A
		metallic	-	FARL/BN-1A	FARL/BP-1A	FARL/BN-3A	FARL/BP-3A
through-beam	20 m (axial)	plastic	emitter	FAIH/00-0A		FAIH/00-2A	
			emitt. + check	FAIH/X0-0A		FAIH/X0-2A	
			receiver	FAIZ/BN-0A	FAIZ/BP-0A	FAIZ/BN-2A	FAIZ/BP-2A
			adj. receiver	FAID/BN-0A	FAID/BP-0A	FAID/BN-2A	FAID/BP-2A
	15 m (90°)	metallic	emitter	FAIH/00-1A		FAIH/00-3A	
			emitt. + check	FAIH/X0-1A		FAIH/X0-3A	
			receiver	FAIZ/BN-0A	FAIZ/BP-0A	FAIZ/BN-2A	FAIZ/BP-2A
			adj. receiver	FAID/BN-1A	FAID/BP-1A	FAID/BN-3A	FAID/BP-3A

## available models

### plug cable exit photoelectric sensors

model	distance	housing	adjustment	4 wires (axial optic)		4 wires (right angle optic)	
				NPN NO + NC	PNP NO + NC	NPN NO + NC	PNP NO + NC
diffuse reflection	100 mm	plastic	-	FAR2/BN-0E	FAR2/BP-0E	FAR2/BN-2E	FAR2/BP-2E
			●	FAR3/BN-0E	FAR3/BP-0E	FAR3/BN-2E	FAR3/BP-2E
		metallic	-	FAR2/BN-1E	FAR2/BP-1E	FAR2/BN-3E	FAR2/BP-3E
			●	FAR3/BN-1E	FAR3/BP-1E	FAR3/BN-3E	FAR3/BP-3E
	200 mm	plastic	-	FAI4/BN-0E	FAI4/BP-0E	FAI4/BN-2E	FAI4/BP-2E
			●	FAI5/BN-0E	FAI5/BP-0E	FAI5/BN-2E	FAI5/BP-2E
		metallic	-	FAI4/BN-1E	FAI4/BP-1E	FAI4/BN-3E	FAI4/BP-3E
			●	FAI5/BN-1E	FAI5/BP-1E	FAI5/BN-3E	FAI5/BP-3E
	400 mm	plastic	-	FAI6/BN-0E	FAI6/BP-0E	FAI6/BN-2E	FAI6/BP-2E
			●	FAI7/BN-0E	FAI7/BP-0E	FAI7/BN-2E	FAI7/BP-2E
		metallic	-	FAI6/BN-1E	FAI6/BP-1E	FAI6/BN-3E	FAI6/BP-3E
			●	FAI7/BN-1E	FAI7/BP-1E	FAI7/BN-3E	FAI7/BP-3E
	1.000 mm (axial)	plastic	●	FAI8/BN-0E	FAI8/BP-0E	FAI8/BN-2E	FAI8/BP-2E
	800 mm (90°)	metallic		FAI8/BN-1E	FAI8/BP-1E	FAI8/BN-3E	FAI8/BP-3E
retroreflective	5 m (axial)	plastic	-	FAIC/BN-0E	FAIC/BP-0E	FAIC/BN-2E	FAIC/BP-2E
			●	FAIM/BN-0E	FAIM/BP-0E	FAIM/BN-2E	FAIM/BP-2E
	4 m (90°)	metallic	-	FAIC/BN-1E	FAIC/BP-1E	FAIC/BN-3E	FAIC/BP-3E
			●	FAIM/BN-1E	FAIM/BP-1E	FAIM/BN-3E	FAIM/BP-3E
polarized	4 m (axial)	plastic	-	FARP/BN-0E	FARP/BP-0E	FARP/BN-2E	FARP/BP-2E
			●	FARN/BN-0E	FARN/BP-0E	FARN/BN-2E	FARN/BP-2E
	2.5 m (90°)	metallic	-	FARP/BN-1E	FARP/BP-1E	FARP/BN-3E	FARP/BP-3E
			●	FARN/BN-1E	FARN/BP-1E	FARN/BN-3E	FARN/BP-3E
trasparents	0,1...1.5 m	plastic	●	FARL/BN-0E	FARL/BP-0E	FARL/BN-2E	FARL/BP-2E
		metallic		FARL/BN-1E	FARL/BP-1E	FARL/BN-3E	FARL/BP-3E
through-beam	20 m (axial)	plastic	emitter	FAIH/00-0E		FAIH/00-2E	
			emitt. + check	FAIH/X0-0E		FAIH/X0-2E	
			receiver	FAIZ/BN-0E	FAIZ/BP-0E	FAIZ/BN-2E	FAIZ/BP-2E
			adj. receiver	FAID/BN-0E	FAID/BP-0E	FAID/BN-2E	FAID/BP-2E
	15 m (90°)	metallic	emitter	FAIH/00-1E		FAIH/00-3E	
			emitt. + check	FAIH/X0-1E		FAIH/X0-3E	
			receiver	FAIZ/BN-0E	FAIZ/BP-0E	FAIZ/BN-2E	FAIZ/BP-2E
			adj. receiver	FAID/BN-1E	FAID/BP-1E	FAID/BN-3E	FAID/BP-3E



	red LED emission	
	FAR2/B*-**	FAR3/B*-**
		
nominal sensing distance	100 mm <sup>(1)</sup>	
emission	red (660 nm)	
hysteresis	≤ 10 %	
repeatability	5 %	
operating voltage	10...30 Vcc	
ripple	≤ 10 %	
no-load supply current	30 mA	
load current	100 mA	
leakage current	10 µA	
output voltage drop	2 V max. I <sub>L</sub> = 100 mA	
output type	NPN or PNP NO + NC	
switching frequency	250 Hz	
power on delay	200 ms	
power supply protections	polarity reversal, impulsive overvoltage	
output protection	Short circuit (autoreset) Overvoltage	
sensitivity adjustment	-	●
operating temperature range	- 25°C...+ 70°C (without freeze)	
temperature drift	10 % Sr	
protection degree	IP67 (EN60529) <sup>(4)</sup>	
EMC	in conformity with the EMC Directive according to EN 60947-5-2	
external light interference	3,000 lux (incandescence lamp), 10,000 lux (sunlight)	
LEDs	Yellow (Light status) or (output status in the LO/DO special versions)	
housing material	PBT (plastic) / nicked plated brass (metallic) / PC (cable exit)	
optic material	PC	
tightening torque	1 Nm (plastic), 25 Nm (metallic)	
weight (approximate)	plastic version: 30 g connector / 50 g cable metallic version: 100 g connector / 130 g cable	

<sup>(1)</sup> White target kodak 90% reflection 100 x 100 mm

<sup>(2)</sup> Protection guaranteed only with plug cable well mounted

		infrared LED emission				
		FAI4/B*-**	FAI5/B*-**	FAI6/B*-**	FAI7/B*-**	FAI8/B*-**
nominal sensing distance		200 mm <sup>(1)</sup>		400 mm <sup>(2)</sup>		1,000 mm <sup>(3)</sup> (axial) 800 mm <sup>(3)</sup> (90°)
emission		infrared (880 nm)				
hysteresis		≤ 10 %				
repeatability		5 %				
operating voltage		10...30 Vcc				
ripple		≤ 10 %				
no-load supply current		30 mA				
load current		100 mA				
leakage current		10 µA				
output voltage drop		2 V max. IL = 100 mA				
output type		NPN or PNP NO + NC				
switching frequency		250 Hz				
power on delay		200 ms				
power supply protections		polarity reversal, impulsive overvoltage				
output protection		Short circuit (autoreset) Overvoltage				
sensitivity adjustment		•		-		•
operating temperature range		- 25°C...+ 70°C (without freeze)				
temperature drift		10 % Sr				
protection degree		IP67 (EN60529) <sup>(4)</sup>				
EMC		in conformity with the EMC Directive according to EN 60947-5-2				
external light interference		3,000 lux (incandescence lamp), 10,000 lux (sunlight)				
LEDs		Yellow (Light status) or (output status in the LO/DO special versions)				
housing material		PBT (plastic) / nicked plated brass (metallic) / PC (cable exit)				
optic material		PC				
tightening torque		1 Nm (plastic), 25 Nm (metallic)				
weight (approximate)		plastic version: 30 g plug / 50 g cable metallic version: 100 g plug / 130 g cable				

<sup>(1)</sup> White target kodak 90% reflection 100 x 100 mm <sup>(2)</sup> White target kodak 90% reflection 200 x 200 mm <sup>(3)</sup> White target kodak 90% reflection 400 x 400 mm

<sup>(4)</sup> Protection guaranteed only with plug cable well mounted



# technical specification

## reflex and polarized models

M18 cylindrical DC

	retroreflective		polarized		transparent objects detection
	FAIC/B*~** (1)	FAIM/B*~** (1)	FARP/B*~** (1)	FARN/B*~** (1)	FARL/B*~** (2)
nominal sensing distance	5 m (axial), 4 m (radial)		4 m (axial), 2.5 m (radial)		1.5 m
emission	infrared (880 nm)		red (660 nm)		
hysteresis	≤ 10 %				
repeatability	5 %				
operating voltage	10...30 Vdc				
ripple	≤ 10 %				
no-load supply current	30 mA				
load current	100 mA				
leakage current	≤ 10 µA				
output voltage drop	2 V max. IL = 100 mA				
output type	NPN or PNP NO + NC				
switching frequency	250 Hz				
power on delay	200 ms				
power supply protections	polarity reversal, impulsive overvoltage				
output protection	Short circuit (autoreset) Overvoltage				
sensitivity adjustment	-	●	-	●	
operating temperature range	- 25°C...+ 70°C (without freeze)				
temperature drift	10 % Sr				
protection degree	IP67 (EN60529) (3)				
EMC	in conformity with the EMC Directive according to EN 60947-5-2				
external light interference	5000 lux (incandescence lamp), 10.000 lux (sunlight)				
LEDs	Yellow (Light status) or (output status in the LO/DO special versions)				
housing material	PBT (plastic) / nicked plated brass (metallic) / PC (cable exit)				
optic material	PC		plastic		PC
tightening torque	1 Nm (plastic), 25 Nm (metallic)				
weight (approximate)	plastic version: 30 g plug / 50 g cable metallic version: 100 g plug / 130 g cable				

(1) With RL 110 reflector (2) With RL 113G or RL 116 reflector (3) Protection guaranteed only with plug cable well mounted



	emitter		receiver	
	FAIH/X0-**	FAIH/00-**	FAIZ/B*-**	FAID/B*-**
nominal sensing distance	20 m axial model / 15 m right angle model			
emission	infrared (880 nm)			
hysteresis	≤ 10 %			
repeatability	5 %			
operating voltage	10...30 Vdc			
ripple	≤ 10 %			
no-load supply current	25 mA			
load current	-		100 mA	
leakage current	-		10 µA	
output voltage drop	-		2 V max. IL = 100 mA	
output type	-		NPN or PNP NO + NC	
switching frequency	-		250 Hz	
power on delay	-		200 ms	
power supply protections	impulsive overvoltage polarity reversal			
output protection	-		Short circuit (autoreset) - Overvoltage	
sensitivity adjustment	-		-	●
operating temperature range	- 25°C...+ 70°C (without freeze)			
temperature drift	10 % Sr			
check input	BK/2 connected to 0 V switches off the emission		-	
EMC	in conformity with the EMC Directive according to EN 60947-5-2			
protection degree	IP67 (EN60529) <sup>(1)</sup>			
external light interference	5,000 lux (incandescence lamp), 10,000 lux (sunlight)			
LEDs	green (power ON)		Yellow (light state or output status in the special LO/DO versions)	
housing material	PBT (plastic) / nicked plated brass (metallic) / PC (cable exit)			
optic material	PC			
tightening torque	1 Nm (plastic), 25 Nm (metallic)			
weight (approximate)	plastic version: 30 g connector / 50 g cable metallic version: 100 g connector / 130 g cable			

<sup>(1)</sup> Protection guaranteed only with plug cable well mounted



M18 cylindrical DC

# electrical diagrams of the connections

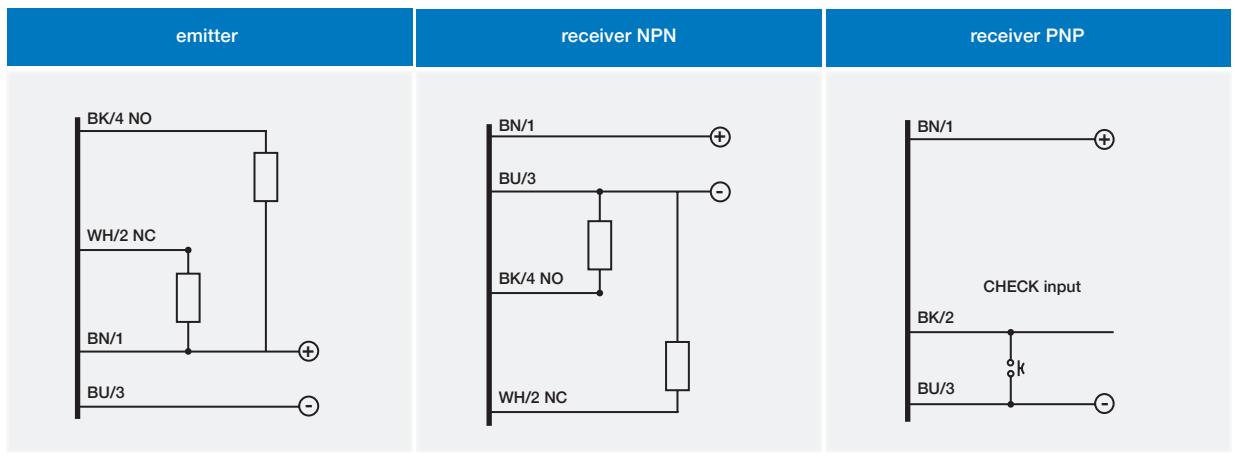

- BN brown
- BU blue
- BK black
- WH white
- PK pink
- GY gray

# plug

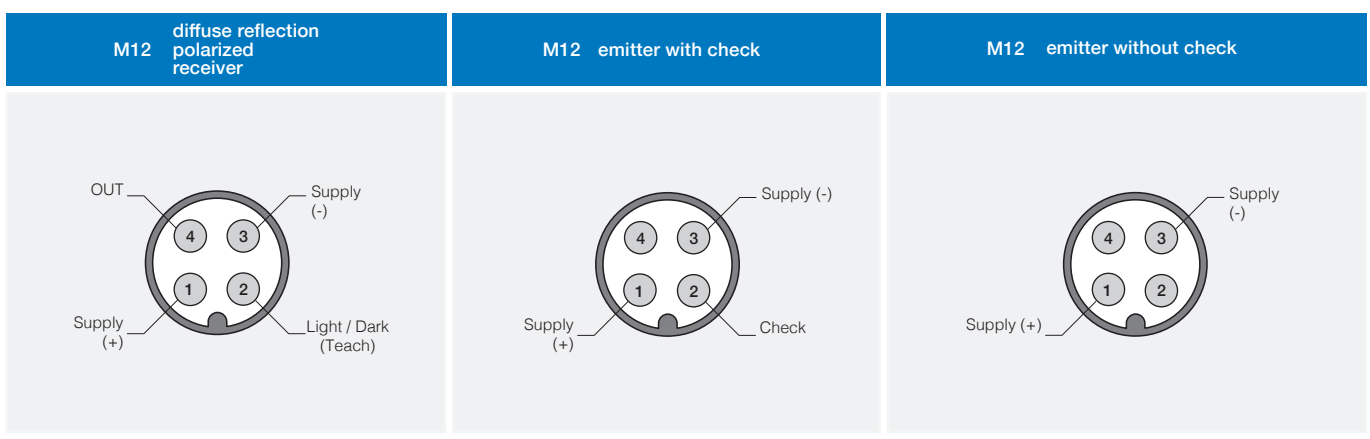

# response diagram

direct diffuse models

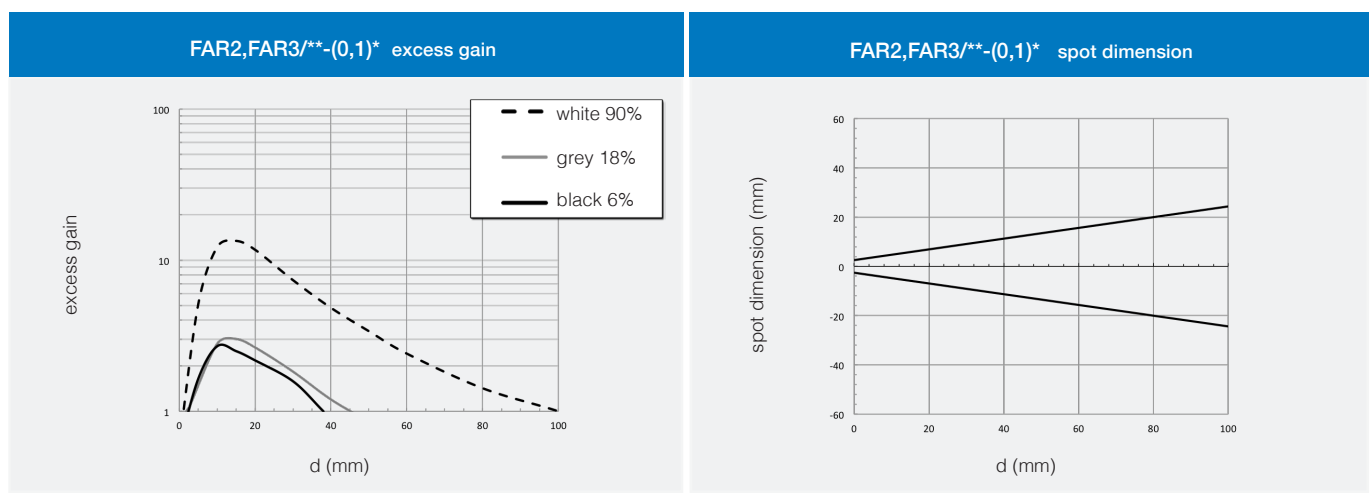

FA





FAR2,FAR3/\*\*-(0,1)\* parallel displacement

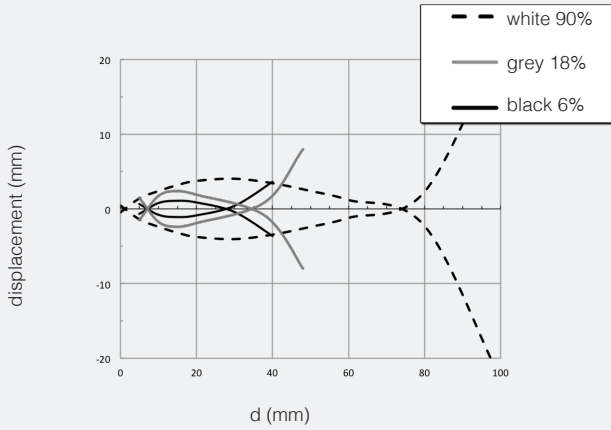

FAR2,FAR3/\*\*-(2,3)\* excess gain

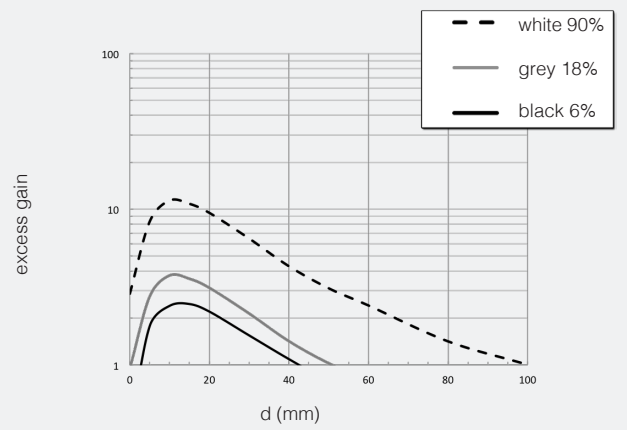

FAR2,FAR3/\*\*-(2,3)\* spot dimension

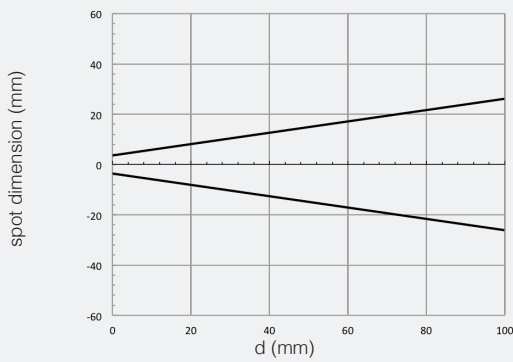

FAR2,FAR3/\*\*-(2,3)\* parallel displacement

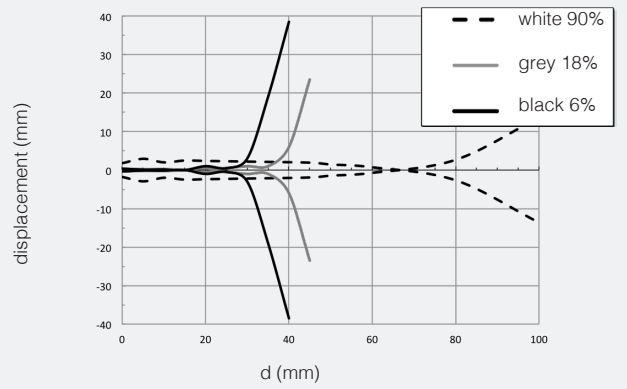

FAI4, FAI5/\*\*-(0,1)\* excess gain

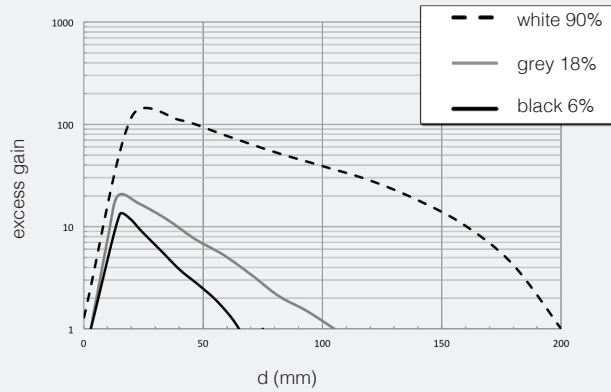

FAI4, FAI5/\*\*-(0,1)\* spot dimension

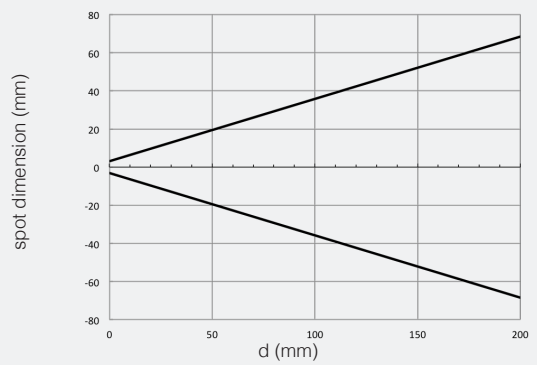

FAI4, FAI5/\*\*-(0,1)\* parallel displacement

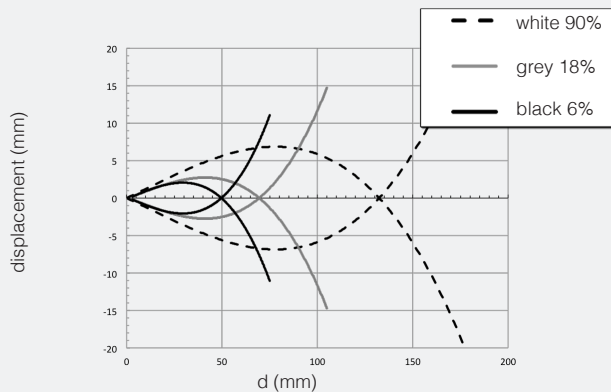

FAI4, FAI5/\*\*-(2,3)\* excess gain

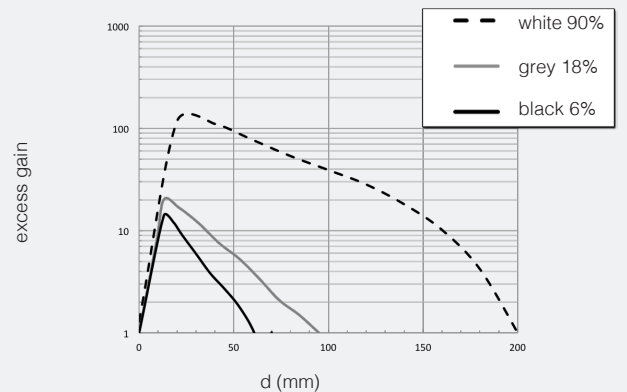



# response diagrams

## direct diffuse models

FAI4, FAI5/\*\*-(2,3)\* spot dimension

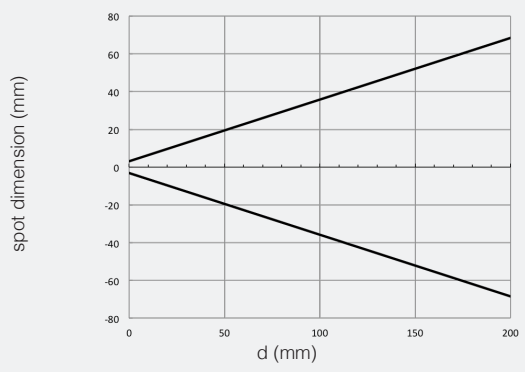

FAI4, FAI5/\*\*-(2,3)\* parallel displacement

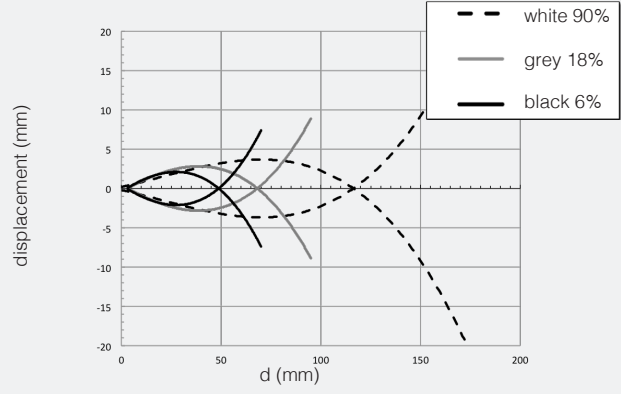

FAI6,FAI7/\*\*-(0,1)\* excess gain

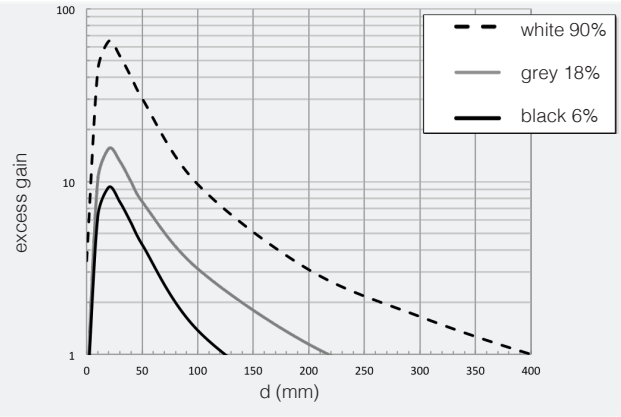

FAI6,FAI7/\*\*-(0,1)\* spot dimension

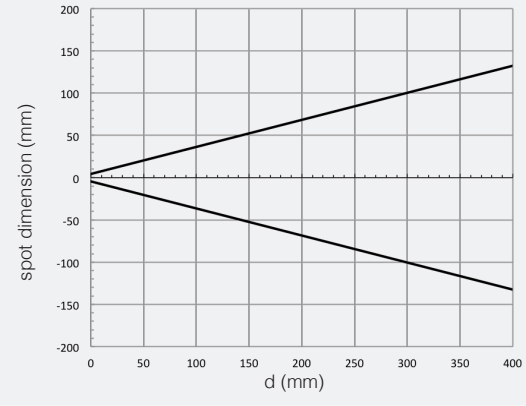

FAI6,FAI7/\*\*-(0,1)\*parallel displacement

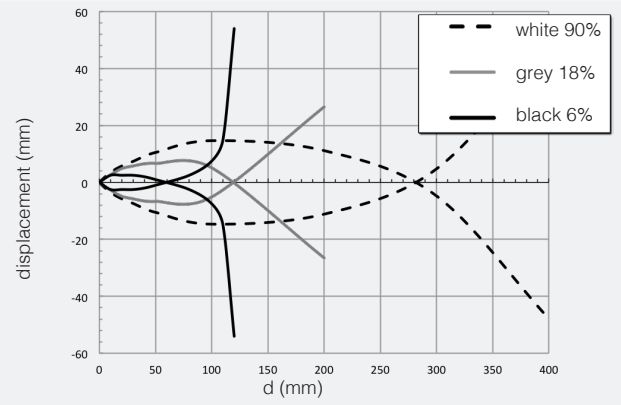

FAI6,FAI7/\*\*-(2,3)\* excess gain

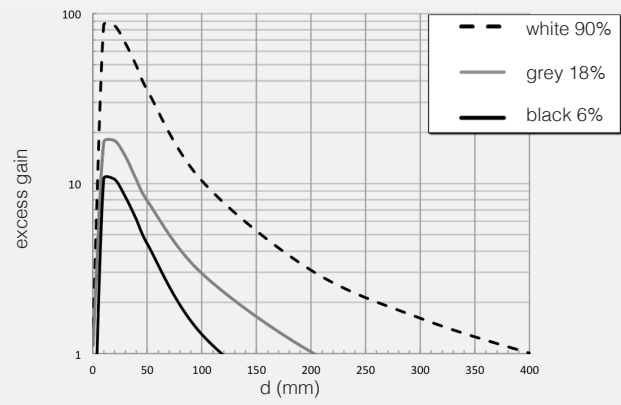

FAI6,FAI7/\*\*-(2,3)\* spot dimension

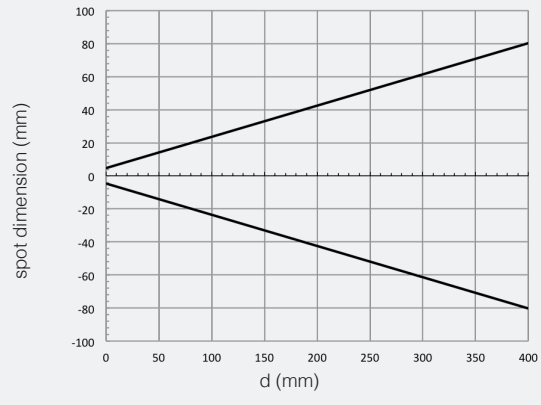

FAI6,FAI7/\*\*-(2,3)\* parallel displacement

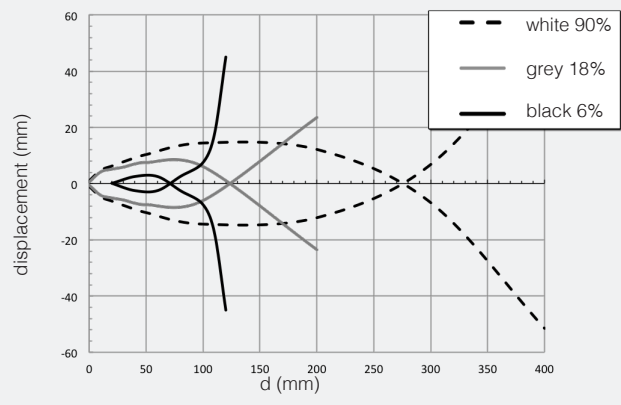



FAI8/\*\*-(0,1)\* excess gain

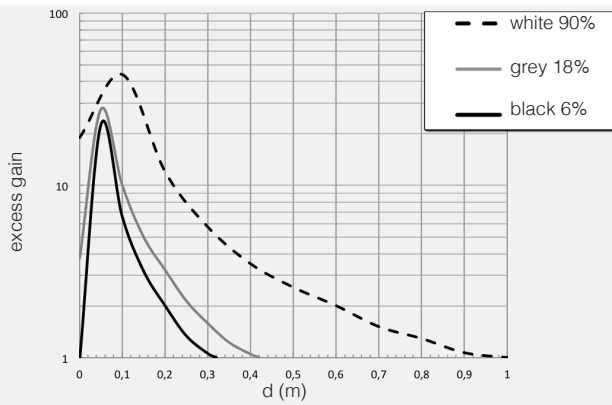

FAI8/\*\*-(0,1)\* spot dimension

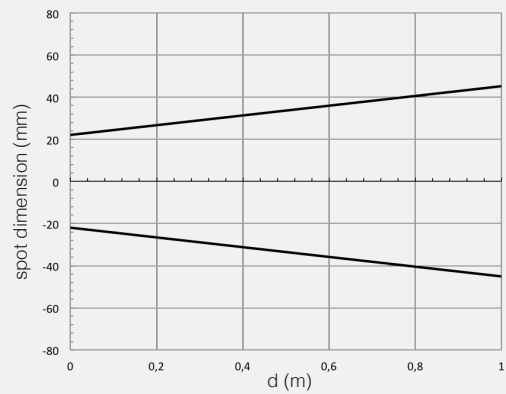

FAI8/\*\*-(0,1)\* parallel displacement

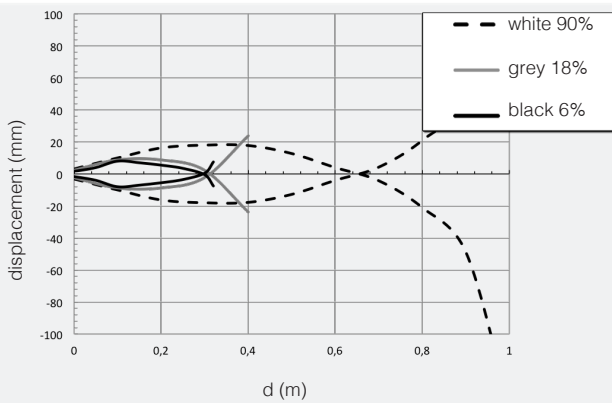

FAI8/\*\*-(2,3)\* excess gain

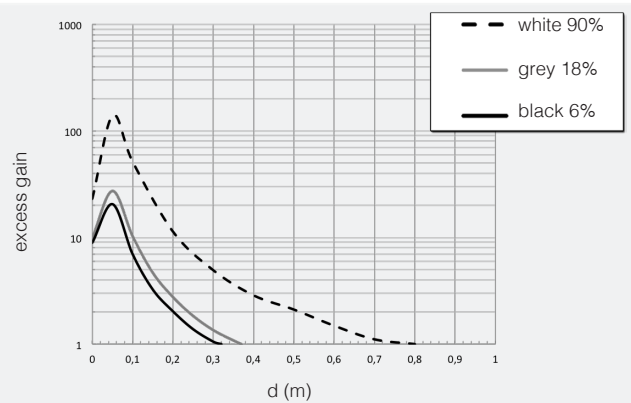

FAI8/\*\*-(2,3)\* spot dimension

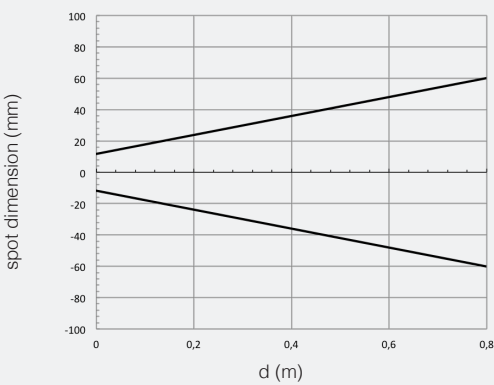

FAI8/\*\*-(2,3)\* parallel displacement

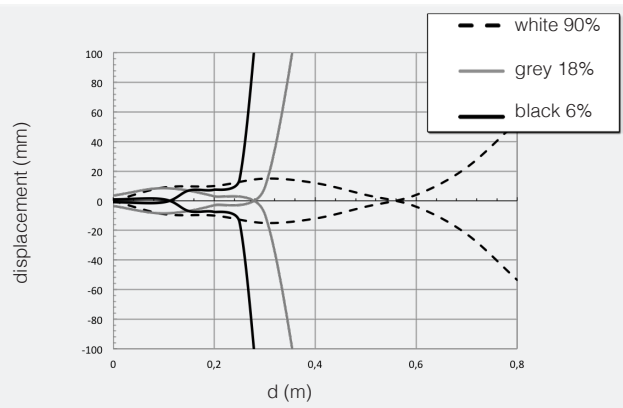



# response diagrams

retro-reflective models

M18 cylindrical DC

FAIC,FAIM/\*\*-(0,1)\* excess gain

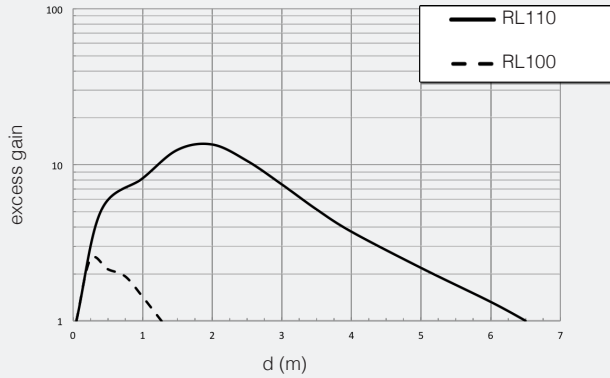

FAIC,FAIM/\*\*-(0,1)\* spot dimension

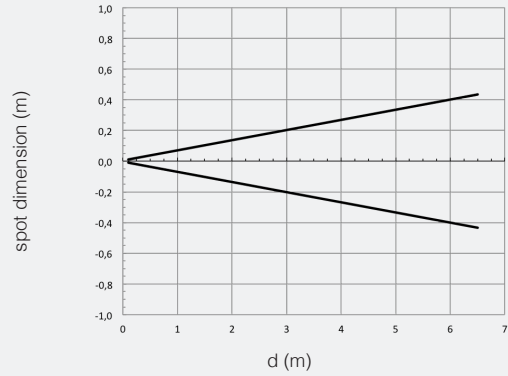

FAIC,FAIM/\*\*-(0,1)\* parallel displacement

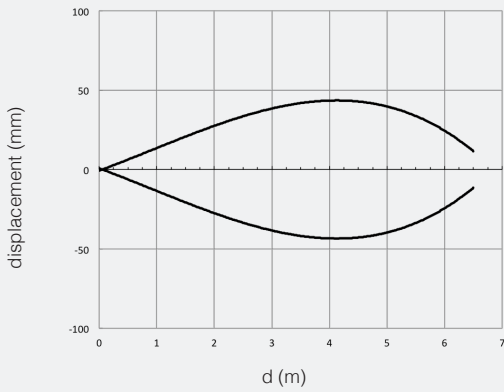

FAIC,FAIM/\*\*-(2,3)\* excess gain

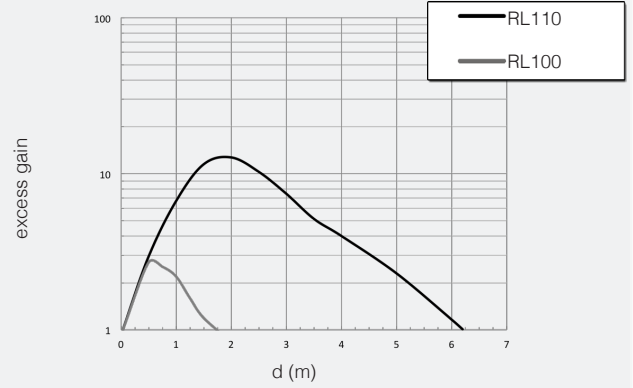

FAIC,FAIM/\*\*-(2,3)\* spot diameter

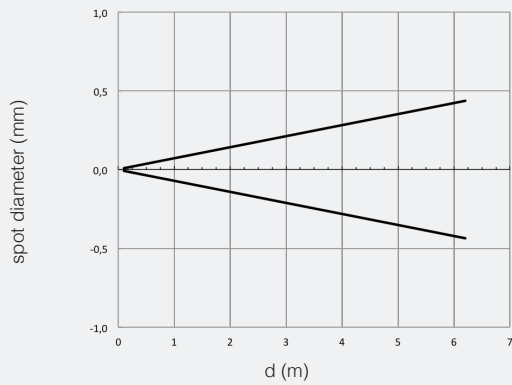

FAIC,FAIM/\*\*-(2,3)\* parallel displacement

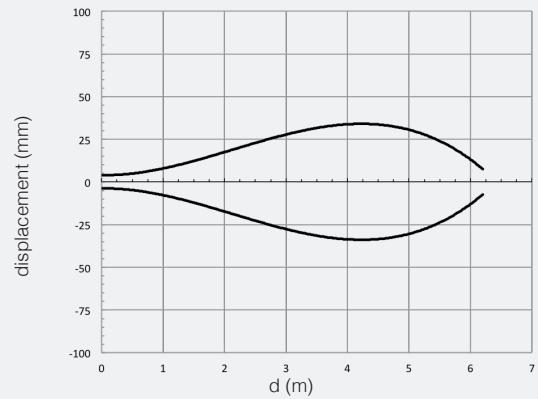

FA

# response diagrams

polarized models



M18 cylindrical DC

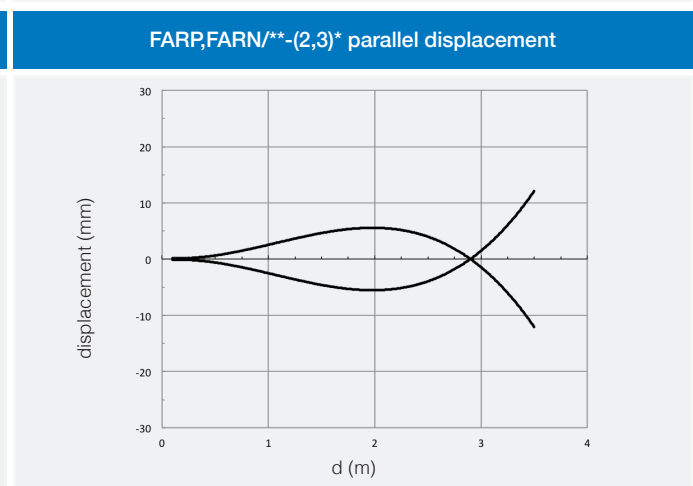
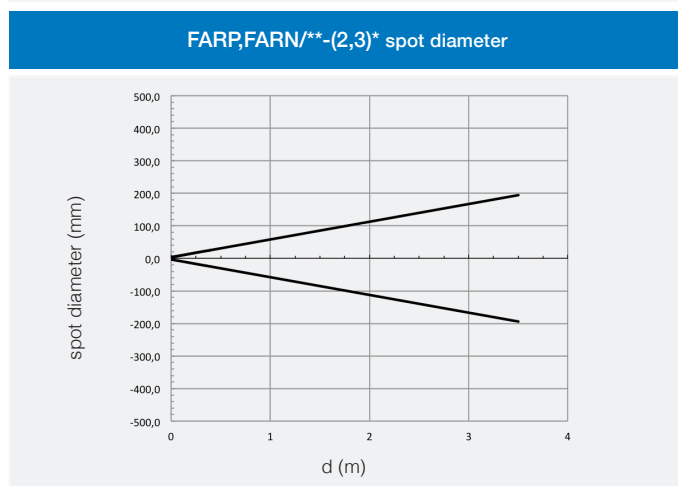
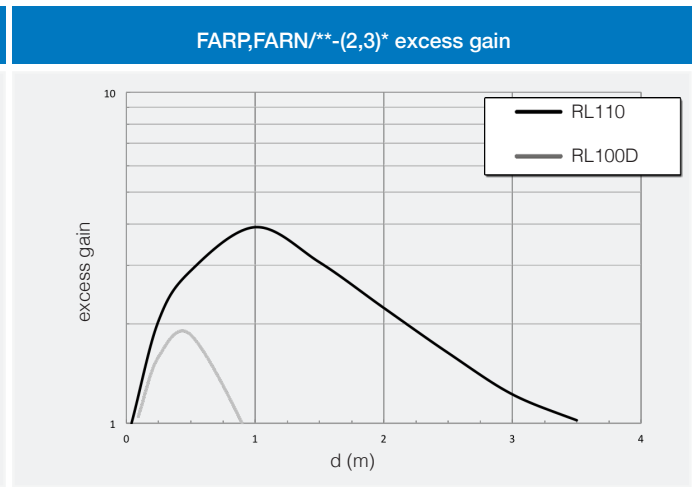
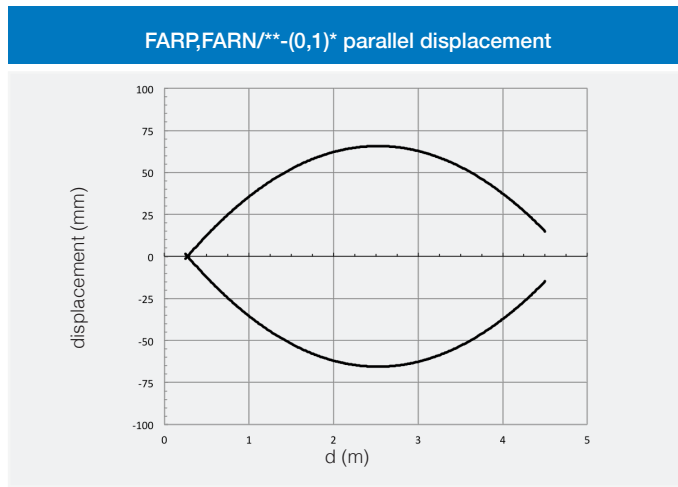
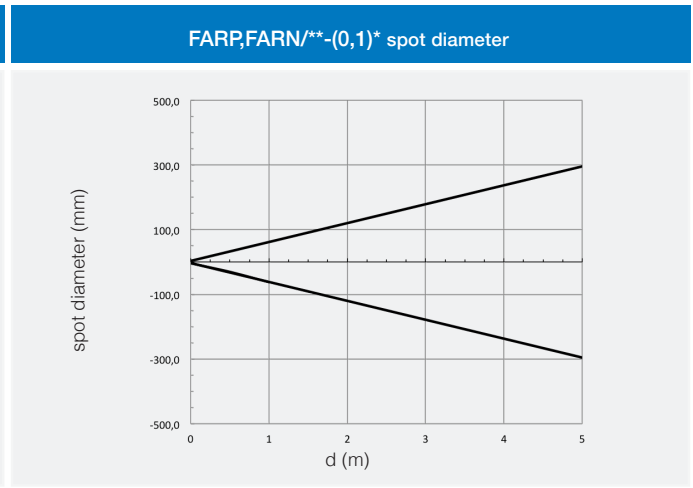
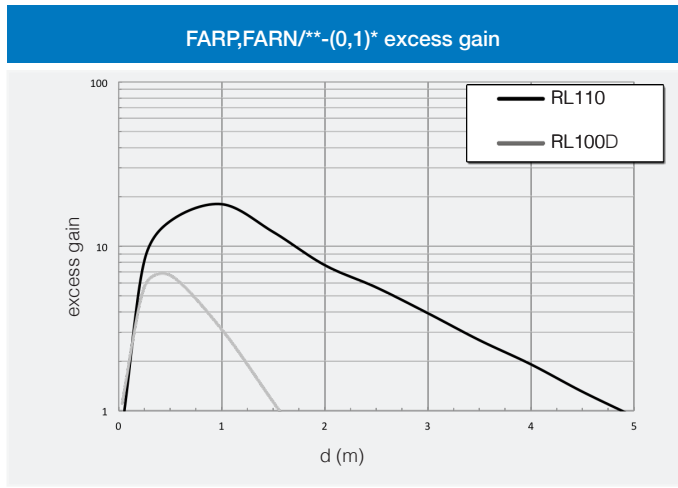

FA



## response diagrams

polarized models for transparent objects (diagrams calculated with RL110)

M18 cylindrical DC

FARL/\*\*-\* excess gain

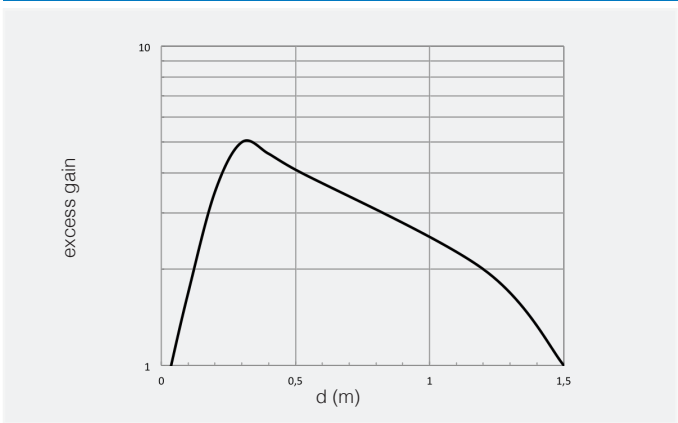

FARL/\*\*-\* spot diameter

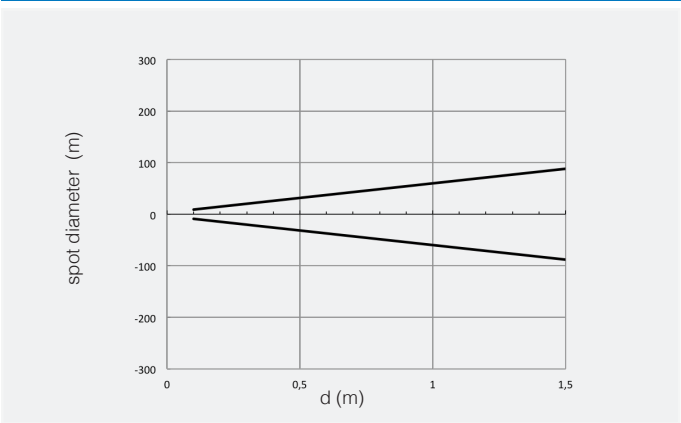

## response diagrams

polarized models for transparent objects

FARL/\*\*-\* parallel displacement

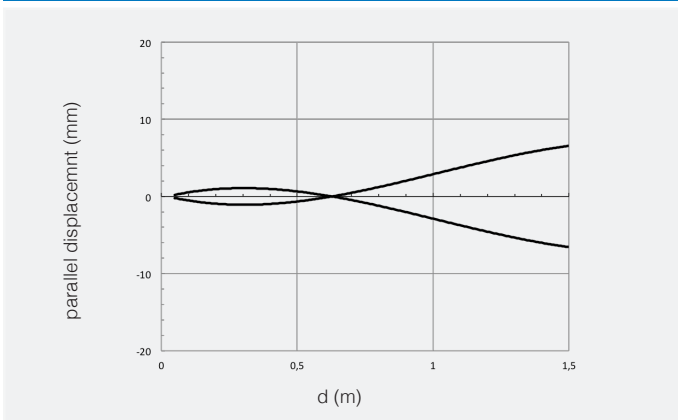

## response diagrams

through beam models

FAIH/\*\*-(0,1)\* FAID/\*\*-(0,1)\*, excess gain

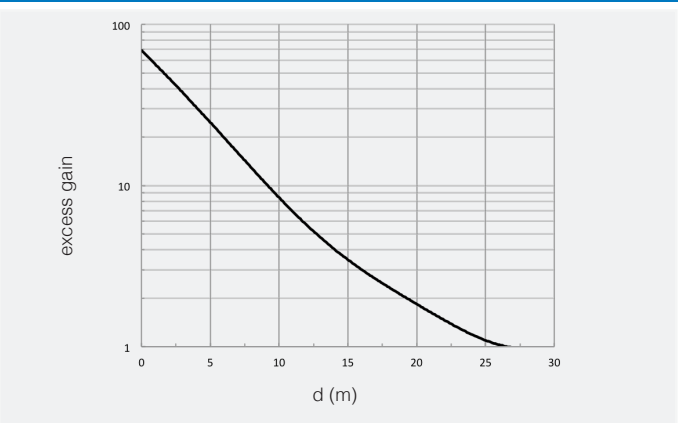

FAIH/\*\*-(0,1)\* FAID/\*\*-(0,1)\*, spot diameter

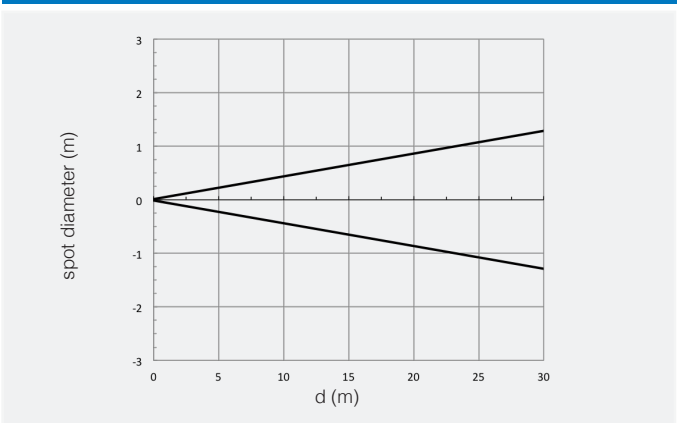

FA



FAIH/\*\*-(0,1)\* FAID/\*\*-(0,1)\*, parallel displacement

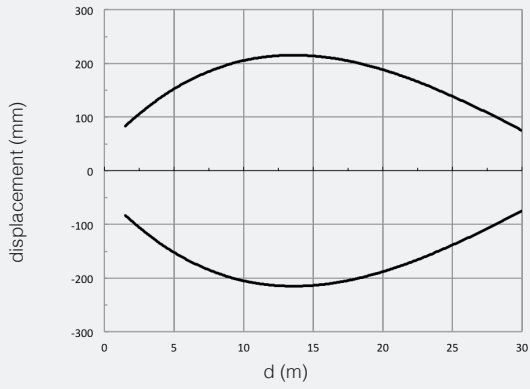

## response diagrams

through beam models

FAIH/\*\*-(2,3)\* FAID/\*\*-(2,3)\*, excess gain

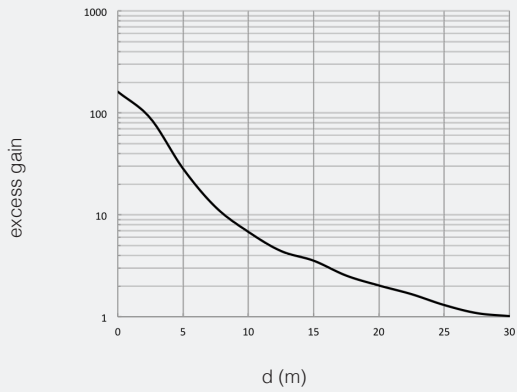

FAIH/\*\*-(2,3)\* FAID/\*\*-(2,3)\*, spot diameter

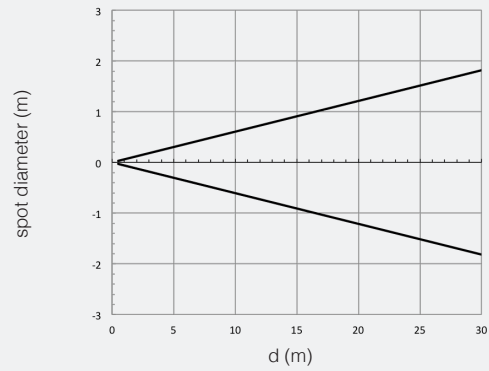

FAIH/\*\*-(2,3)\* FAID/\*\*-(2,3)\*, parallel displacement

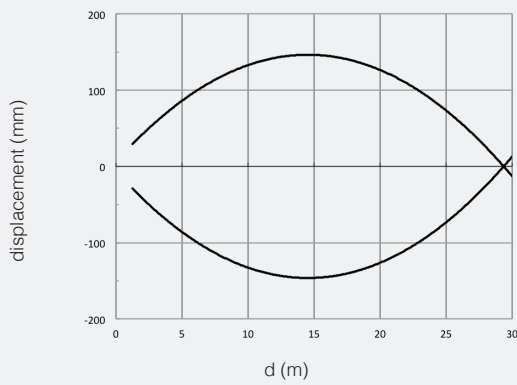



# dimensions (mm)

M18 cylindrical DC

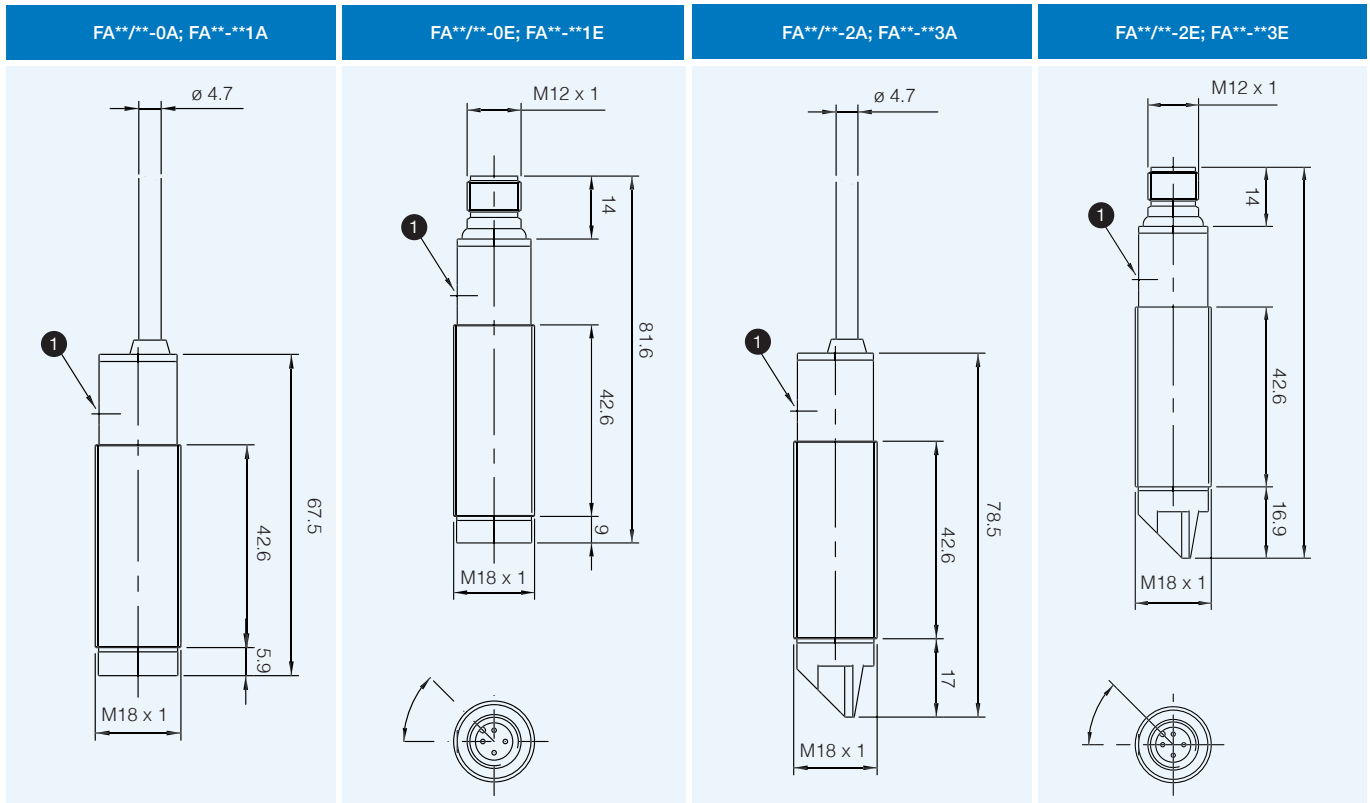

1 Trimmer for sensibility regulation

## dimensions (mm)

accessories included in all plastic models

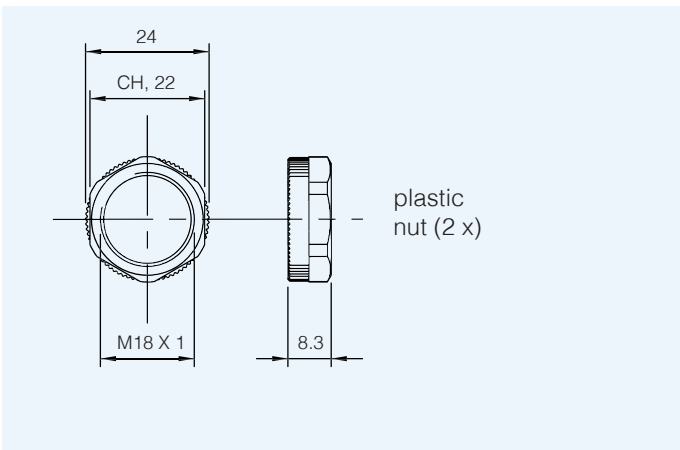

## dimensions (mm)

accessories included in all metallic models

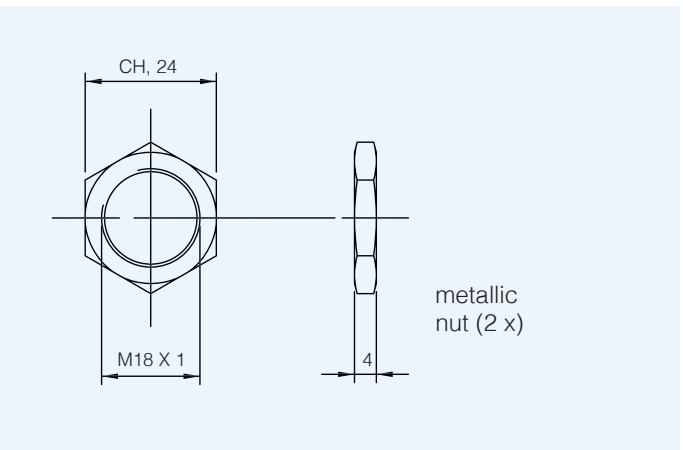

FA