

IN450

The incubator I is perfect for the world of research, medicine, pharmaceuticals and food analytics, as well as food chemistry.

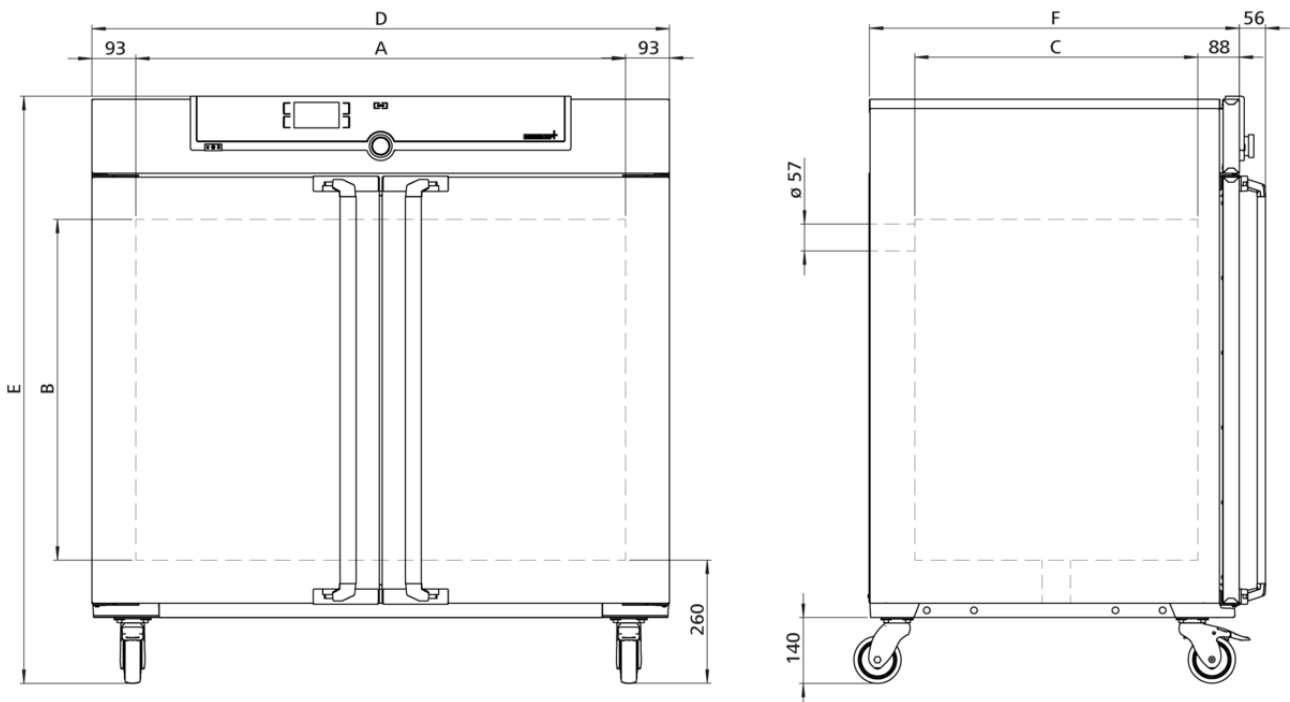

The heating of this incubator is optimally tuned for natural convection and valuable chamber loads for research, pharmaceuticals, medicine and food chemistry are warmed up very carefully. On this page, you can find all the essential technical data on our incubator. Our customer relations team will be pleased to help if you want further information. If you should require a customised special solution, please contact our technical specialists at sales@memmert.com.



Temperature

Setting temperature range +20 to +80 °C

Working temperature range at least 5 above ambient temperature to +80 °C

Setting accuracy temperature 0.1 °C

Temperature sensor 1 Pt100 sensor DIN class A in 4-wire-circuit

Control technology

Language setting German, English, Spanish, French, Polish, Czech, Hungarian

ControlCOCKPIT SingleDISPLAY. Adaptive multifunctional digital PID-microprocessor controller with high-definition TFT-colour display

Timer Digital backwards counter with target time setting, adjustable from 1 minute to 99 days

Function SetpointWAIT the process time does not start until the set temperature is reached

Calibration three freely selectable temperature values

adjustable parameters temperature (Celsius or Fahrenheit), air flap position, programme time, time zones, summertime/wintertime

Ventilation

Convection natural convection

Fresh air Admixture of pre-heated fresh air by electronically adjustable air flap

Vent vent connection with restrictor flap

Communication

Documentation programme stored in case of power failure

Programming AtmoCONTROL software for reading out, managing and organising the data logger via Ethernet interface (temporary trial version can be downloaded). USB stick with AtmoCONTROL software available as accessory (on demand).

Safety

Temperature control adjustable electronic overtemperature monitor and mechanical temperature limiter TB, protection class 1 according to DIN 12880 to switch off the heating approx. 20°C above nominal temperature

Autodiagnostic system for fault analysis

Standard equipment

Works calibration certificate incl. works calibration certificate for +37°C

Door inner glass doors

Door fully insulated stainless steel doors with 2-point locking (compression door lock)

Internals 2 stainless steel grid(s), electropolished

Stainless steel interior

Interior	easy-to-clean interior, made of stainless steel, reinforced by deep drawn ribbing with integrated and protected large-area heating on four sides
Volume	449 l
Dimensions	$w_{(A)} \times h_{(B)} \times d_{(C)}$: 1040 x 720 x 600 mm
Max. number of internals	8
Max. loading of chamber	300 kg
Max. loading per internal	30 kg

Textured stainless steel casing

Dimensions	$w_{(D)} \times h_{(E)} \times d_{(F)}$: 1224 x 1247 x 784 mm (d +56mm door handle)
Installation	on lockable castors
Housing	rear zinc-plated steel

Electrical data

Voltage	230 V, 50/60 Hz
Electrical load	approx. 1800 W
Voltage	115 V, 50/60 Hz
Electrical load	approx. 1500 W

Ambient conditions

Set Up	The distance between the wall and the rear of the appliance must be at least 15 cm. The clearance from the ceiling must not be less than 20 cm and the side clearance from walls or nearby appliances must not be less than 5 cm.
Altitude of installation	max. 2,000 m above sea level
Ambient temperature	+5 °C to +40 °C
Humidity rh	max. 80 %, non-condensing
Overvoltage category	II
Pollution degree	2

Packing/shipping data

Transport information	The appliances must be transported upright
Customs tariff number	8419 8998
Country of origin	Federal Republic of Germany
WEEE-Reg.-No.	DE 66812464
Dimensions approx incl. carton	w x h x d: 1330 x 1440 x 1050 mm
Net weight	approx. 161 kg
Gross weight carton	approx. 227 kg

Standard units are safety-approved and bear the test marks

