

# Product data sheet

Specifications



variable speed drive, Altivar 212,  
55kW, 75hp, 480V, 3 phases, with  
EMC, IP21

ATV212HD55N4

Product availability: Stock - Normally stocked in distribution facility

**Price\*: 5,646.00 USD**

## Main

Device Short Name	ATV212
Product Destination	Asynchronous motors
Phase	3 phase
Motor Power Kw	55 kW
Maximum Horse Power Rating	75 hp
Supply Voltage Limits	323...528 V
Supply Frequency	50...60 Hz - 5...5 %
Line Current	102.7 A 380 V 89 A 480 V
Range Of Product	Altivar 212
Product Or Component Type	Variable speed drive
Product Specific Application	Pumps and fans in HVAC
Communication Port Protocol	METASYS N2 BACnet LonWorks APOGEE FLN Modbus
[Us] Rated Supply Voltage	380...480 V - 15...10 %
Emc Filter	Class C2 EMC filter integrated
Ip Degree Of Protection	IP21

## Complementary

Apparent Power	76.3 kVA 380 V
Continuous Output Current	116 A 380 V 116 A 460 V
Maximum Transient Current	127.6 A 60 s
Speed Drive Output Frequency	0.5...200 Hz
Speed Range	1...10
Speed Accuracy	+/- 10 % of nominal slip 0.2 Tn to Tn
Local Signalling	for DC bus energized 1 LED (red)
Output Voltage	<= power supply voltage
Isolation	Electrical between power and control

Price is "List Price" and may be subject to a trade discount – check with your local distributor or retailer for actual price.

<b>Type Of Cable</b>	Without mounting kit 1 IEC cable 113 °F (45 °C), copper 90 °C / XLPE/EPR Without mounting kit 1 IEC cable 113 °F (45 °C), copper 70 °C / PVC With UL Type 1 kit 3 UL 508 cable 104 °F (40 °C), copper 75 °C / PVC
<b>Electrical Connection</b>	VIA, VIB, FM, FLA, FLB, FLC, RY, RC, F, R, RES terminal 0.00 in <sup>2</sup> (2.5 mm <sup>2</sup> ) / AWG 14 L1/R, L2/S, L3/T terminal 0.23 in <sup>2</sup> (150 mm <sup>2</sup> ) 300 kcmil)
<b>Tightening Torque</b>	5.31 lbf.in (0.6 N.m) VIA, VIB, FM, FLA, FLB, FLC, RY, RC, F, R, RES) 362.88 lbf.in (41 N.m), 360 lb.in L1/R, L2/S, L3/T)
<b>Supply</b>	Internal supply for reference potentiometer (1 to 10 kOhm) 10.5 V DC +/- 5 %, <10 A overload and short-circuit protection Internal supply 24 V DC 21...27 V), <200 A overload and short-circuit protection
<b>Sampling Duration</b>	2 ms +/- 0.5 ms F discrete 2 ms +/- 0.5 ms R discrete 2 ms +/- 0.5 ms RES discrete 3.5 ms +/- 0.5 ms VIA analog 22 ms +/- 0.5 ms VIB analog
<b>Response Time</b>	FM 2 ms +/- 0.5 ms analog FLA, FLC 7 ms +/- 0.5 ms discrete FLB, FLC 7 ms +/- 0.5 ms discrete RY, RC 7 ms +/- 0.5 ms discrete
<b>Accuracy</b>	+/- 0.6 % (VIA) for a temperature variation 60 °C +/- 0.6 % (VIB) for a temperature variation 60 °C +/- 1 % (FM) for a temperature variation 60 °C
<b>Linearity Error</b>	VIA +/- 0.15 % of maximum value input VIB +/- 0.15 % of maximum value input FM +/- 0.2 % output
<b>Analogue Output Type</b>	FM switch-configurable voltage 0...10 V DC 7620 Ohm 10 bits FM switch-configurable current 0...20 mA 970 Ohm 10 bits
<b>Discrete Output Type</b>	Configurable relay logic FLA, FLC) NO - 100000 cycles Configurable relay logic FLB, FLC) NC - 100000 cycles Configurable relay logic RY, RC) NO - 100000 cycles
<b>Minimum Switching Current</b>	3 mA 24 V DC configurable relay logic
<b>Maximum Switching Current</b>	5 A 250 V AC resistive cos phi = 1 L/R = 0 ms FL, R) 5 A 30 V DC resistive cos phi = 1 L/R = 0 ms FL, R) 2 A 250 V AC inductive cos phi = 0.4 L/R = 7 ms FL, R) 2 A 30 V DC inductive cos phi = 0.4 L/R = 7 ms FL, R)
<b>Discrete Input Type</b>	F programmable 24 V DC level 1 PLC 4700 Ohm R programmable 24 V DC level 1 PLC 4700 Ohm RES programmable 24 V DC level 1 PLC 4700 Ohm
<b>Discrete Input Logic</b>	Positive logic (source) F, R, RES), <= 5 V, >= 11 V Negative logic (sink) F, R, RES), >= 16 V, <= 10 V
<b>Dielectric Strength</b>	3535 V DC between earth and power terminals 5092 V DC between control and power terminals
<b>Insulation Resistance</b>	>= 1 mOhm 500 V DC for 1 minute
<b>Frequency Resolution</b>	Display unit 0.1 Hz Analog input 0.024/50 Hz
<b>Communication Service</b>	Time out setting from 0.1 to 100 s Write multiple registers (16) 2 words maximum Write single register (06) Read holding registers (03) 2 words maximum Read device identification (43) Monitoring inhabitable
<b>Option Card</b>	Communication card LonWorks
<b>Power Dissipation In W</b>	1455 W
<b>Air Flow</b>	131560.04 Gal/hr(US) (498 m3/h)
<b>Functionality</b>	Mid
<b>Specific Application</b>	HVAC

<b>Variable Speed Drive Application Selection</b>	Building - HVAC compressor for scroll Building - HVAC fan Building - HVAC pump
<b>Motor Power Range Ac-3</b>	55...100 kW 380...440 V 3 phase 55...100 kW 480...500 V 3 phase
<b>Motor Starter Type</b>	Variable speed drive
<b>Discrete Output Number</b>	2
<b>Analogue Input Number</b>	2
<b>Analogue Input Type</b>	VIA switch-configurable voltage 0...10 V DC 24 V max 30000 Ohm 10 bits VIB configurable voltage 0...10 V DC 24 V max 30000 Ohm 10 bits VIB configurable PTC probe 0...6 probes 1500 Ohm VIA switch-configurable current 0...20 mA 250 Ohm 10 bits
<b>Analogue Output Number</b>	1
<b>Physical Interface</b>	2-wire RS 485
<b>Connector Type</b>	1 open style 1 RJ45
<b>Transmission Rate</b>	9600 bps or 19200 bps
<b>Transmission Frame</b>	RTU
<b>Number Of Addresses</b>	1...247
<b>Data Format</b>	8 bits, 1 stop, odd even or no configurable parity
<b>Type Of Polarization</b>	No impedance
<b>Asynchronous Motor Control Profile</b>	Voltage/frequency ratio, automatic IR compensation (U/f + automatic Uo) Flux vector control without sensor, standard Voltage/frequency ratio, 5 points Voltage/frequency ratio - Energy Saving, quadratic U/f Voltage/frequency ratio, 2 points
<b>Torque Accuracy</b>	+/- 15 %
<b>Transient Overtorque</b>	120 % of nominal motor torque +/- 10 % 60 s
<b>Acceleration And Deceleration Ramps</b>	Automatic based on the load Linear adjustable separately from 0.01 to 3200 s
<b>Motor Slip Compensation</b>	Adjustable Automatic whatever the load Not available in voltage/frequency ratio motor control
<b>Switching Frequency</b>	6...16 kHz adjustable 8...16 kHz with derating factor
<b>Nominal Switching Frequency</b>	8 kHz
<b>Braking To Standstill</b>	By DC injection
<b>Network Frequency</b>	47.5...63 Hz
<b>Prospective Line Isc</b>	22 kA
<b>Protection Type</b>	Overheating protection drive Thermal power stage drive Short-circuit between motor phases drive Input phase breaks drive Overcurrent between output phases and earth drive Overvoltages on the DC bus drive Break on the control circuit drive Against exceeding limit speed drive Line supply overvoltage and undervoltage drive Line supply undervoltage drive Against input phase loss drive Thermal protection motor Motor phase break motor With PTC probes motor
<b>Width</b>	12.60 in (320 mm)

<b>Height</b>	24.80 in (630 mm)
<b>Depth</b>	11.42 in (290 mm)

## Environment

<b>Pollution Degree</b>	3 IEC 61800-5-1
<b>Ip Degree Of Protection</b>	IP20 on upper part without blanking plate on cover IEC 61800-5-1 IP20 on upper part without blanking plate on cover IEC 60529 IP21 IEC 61800-5-1 IP21 IEC 60529 IP41 on upper part IEC 61800-5-1 IP41 on upper part IEC 60529
<b>Vibration Resistance</b>	1.5 mm 3...13 Hz)IEC 60068-2-6 1 gn 13...200 Hz)EN/IEC 60068-2-8
<b>Shock Resistance</b>	15 gn 11 ms IEC 60068-2-27
<b>Environmental Characteristic</b>	Classes 3C1 IEC 60721-3-3 Classes 3S2 IEC 60721-3-3
<b>Noise Level</b>	63.7 dB 86/188/EEC
<b>Operating Altitude</b>	3280.84...9842.52 ft (1000...3000 m) limited to 2000 m for the Corner Grounded distribution network with current derating 1 % per 100 m <= 3280.84 ft (1000 m) without derating
<b>Relative Humidity</b>	5...95 % without condensation IEC 60068-2-3 5...95 % without dripping water IEC 60068-2-3
<b>Ambient Air Temperature For Operation</b>	14...104 °F (-10...40 °C) without derating) 104...122 °F (40...50 °C) with derating factor)
<b>Operating Position</b>	Vertical +/- 10 degree
<b>Product Certifications</b>	C-tick UL CSA NOM 117
<b>Marking</b>	CE
<b>Standards</b>	IEC 61800-3 environments 1 category C1 IEC 61800-3 environments 1 category C3 IEC 61800-5-1 IEC 61800-3 IEC 61800-3 environments 2 category C1 IEC 61800-3 IEC 61800-3 environments 1 category C2 EN 55011 class A group 1 IEC 61800-3 environments 1 category C1 IEC 61800-3 environments 2 category C3 IEC 61800-3 environments 1 category C2 IEC 61800-3 environments 2 category C3 IEC 61800-3 environments 2 category C2 UL Type 1 IEC 61800-3 category C2 IEC 61800-3 category C3 IEC 61800-5-1 EN 61800-3 category C3 IEC 61800-3 environments 2 category C2 IEC 61800-3 environments 1 category C3 IEC 61800-3 category C2 IEC 61800-3 environments 2 category C1
<b>Assembly Style</b>	With heat sink
<b>Electromagnetic Compatibility</b>	Electrostatic discharge immunity test level 3 IEC 61000-4-2 Radiated radio-frequency electromagnetic field immunity test level 3 IEC 61000-4-3 Electrical fast transient/burst immunity test level 4 IEC 61000-4-4 1.2/50 µs - 8/20 µs surge immunity test level 3 IEC 61000-4-5 Conducted radio-frequency immunity test level 3 IEC 61000-4-6 Voltage dips and interruptions immunity test IEC 61000-4-11
<b>Regulation Loop</b>	Adjustable PI regulator

---

Ambient Air Temperature For Storage -13...158 °F (-25...70 °C)

## Ordering and shipping details

---

Category US1CP4D22158

---

Discount Schedule CP4D

---

Gtin 3606480322587

---

Returnability Yes

---

Country Of Origin CN

---

## Packing Units

---

Unit Type Of Package 1 PCE

---

Number Of Units In Package 1 1

---

Package 1 Height 18.50 in (47 cm)

---

Package 1 Width 19.69 in (50 cm)

---

Package 1 Length 30.31 in (77 cm)

---

Package 1 Weight 93.70 lb(US) (42.5 kg)

---

## Contractual warranty

---

Warranty 18 months

---

## Sustainability

**Green Premium™ label** is Schneider Electric's commitment to delivering products with best-in-class environmental performance. Green Premium promises compliance with the latest regulations, transparency on environmental impacts, as well as circular and low-CO<sub>2</sub> products.

**Guide to assessing product sustainability** is a white paper that clarifies global eco-label standards and how to interpret environmental declarations.

[Learn more about Green Premium >](#)

[Guide to assess a product's sustainability >](#)



Transparency RoHS/REACH

## Well-being performance

Mercury Free

Rohs Exemption Information Yes

## Certifications & Standards

Reach Regulation [REACH Declaration](#)

Eu Rohs Directive Pro-active compliance (Product out of EU RoHS legal scope)

China Rohs Regulation [China RoHS declaration](#)

Environmental Disclosure [Product Environmental Profile](#)

Weee The product must be disposed on European Union markets following specific waste collection and never end up in rubbish bins.

Circularity Profile [End of Life Information](#)

California Proposition 65 WARNING: This product can expose you to chemicals including: Lead and lead compounds, which is known to the State of California to cause cancer and birth defects or other reproductive harm. For more information go to [www.P65Warnings.ca.gov](http://www.P65Warnings.ca.gov)

Dimensions Drawings

Dimensions

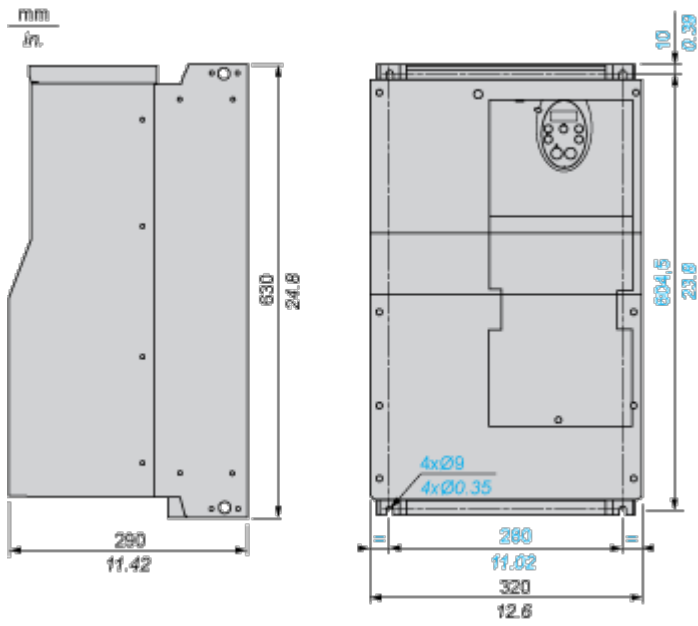

EMC mounting plate (supplied with drive)

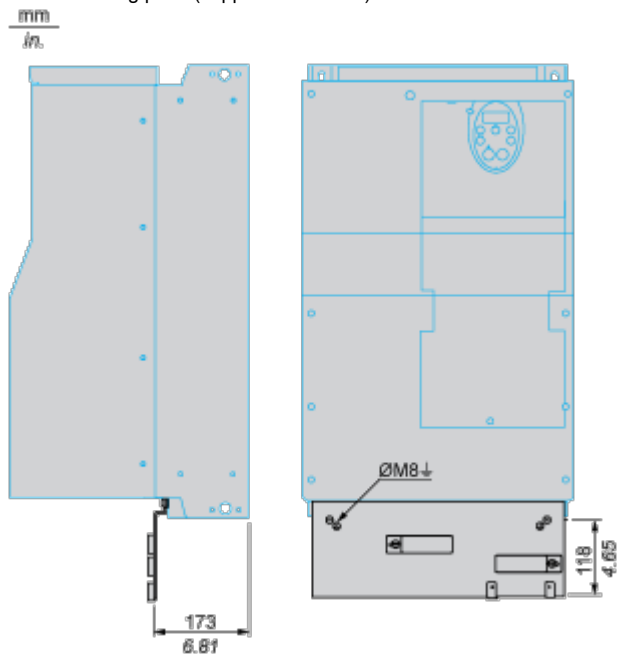

Mounting and Clearance

Mounting Recommendations

Clearance

Depending on the conditions in which the drive is to be used, its installation will require certain precautions and the use of appropriate accessories.

Install the unit vertically:

- Do not place it close to heating elements.
- Leave sufficient free space to ensure that the air required for cooling purposes can circulate from bottom to the top of the unit.

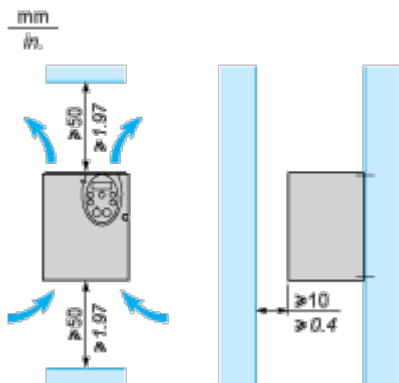

Mounting Types

Type A mounting

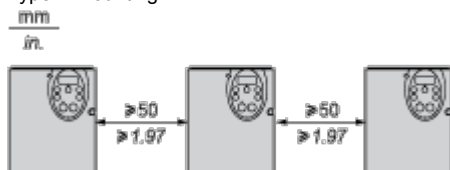

Type B mounting

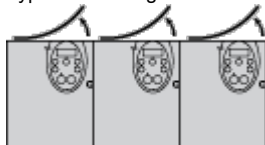

Type C mounting

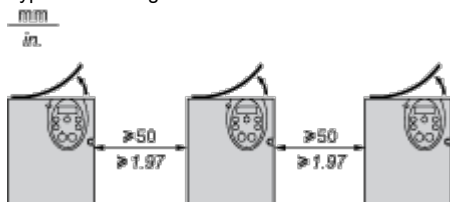

By removing the protective blanking cover from the top of the drive, the degree of protection for the drive becomes IP21. The protective blanking cover may vary according to the drive model, see opposite.



**Specific Recommendations for Mounting in an Enclosure**

---

To help ensure proper air circulation in the drive:

- Fit ventilation grilles.
- Check that there is sufficient ventilation. If there is not, install a forced ventilation unit with a filter. The openings and/or fans must provide a flow rate at least equal to that of the drive fans (refer to the product

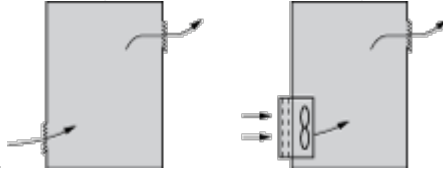

characteristics).

- Use special filters with UL Type 12/IP54 protection.
- Remove the blanking cover from the top of the drive.

**Sealed Metal Enclosure (IP54 Degree of Protection)**

The drive must be mounted in a dust and damp proof enclosure in certain environmental conditions, such as dust, corrosive gases, high humidity with risk of condensation and dripping water, splashing liquid, etc. This enables the drive to be used in an enclosure where the maximum internal temperature reaches 50°C.

Connections and Schema

Recommended Wiring Diagram

3-Phase Power Supply

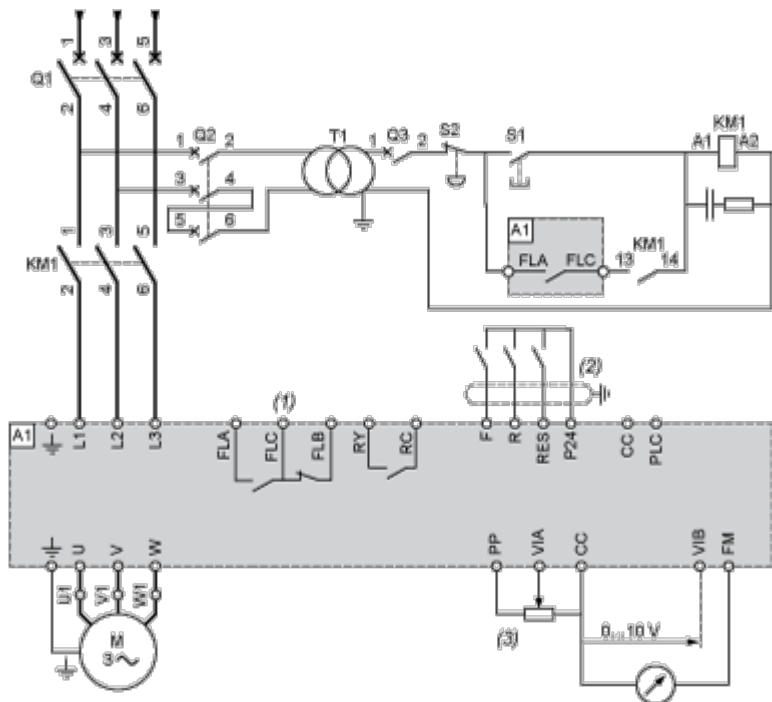

A1: ATV 212 drive

KM1: Contactor

Q1: Circuit breaker

Q2: GV2 L rated at twice the nominal primary current of T1

Q3: GB2CB05

S1, S2: XB4 B or XB5 A pushbuttons

T1: 100 VA transformer 220 V secondary

(1) Fault relay contacts for remote signalling of the drive status

(2) Connection of the common for the logic inputs depends on the positioning of the switch (Source, PLC, Sink)

(3) Reference potentiometer SZ1RV1202

**NOTE:** All terminals are located at the bottom of the drive. Install interference suppressors on all inductive circuits near the drive or connected on the same circuit, such as relays, contactors, solenoid valves, fluorescent lighting, etc.

Switches (Factory Settings)

Voltage/current selection for analog I/O (VIA and VIB)



Voltage/current selection for analog I/O (FM)



Selection of logic type

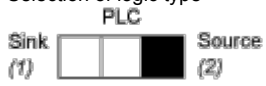

(1) negative logic

(2) positive logic

Other Possible Wiring Diagrams

Logic Inputs According to the Position of the Logic Type Switch

“Source” position

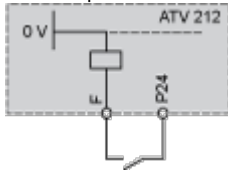

“Sink” position

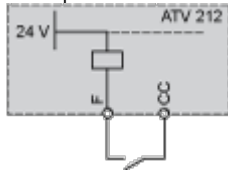

“PLC” position with PLC transistor outputs

<p>(1) PLC</p>	<p>(1) PLC</p>
----------------	----------------

2-wire control

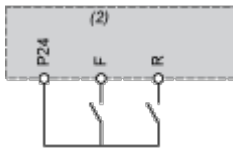

F: Forward

R: Preset speed

(2) ATV 212 control terminals

3-wire control

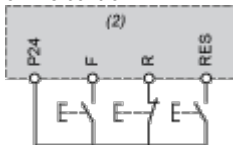

F: Forward

R: Stop

RES: Reverse

(2) ATV 212 control terminals

PTC probe

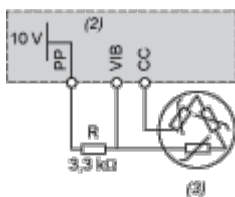

- (2) ATV 212 control terminals
- (3) Motor

**Analog Inputs**

Voltage analog inputs

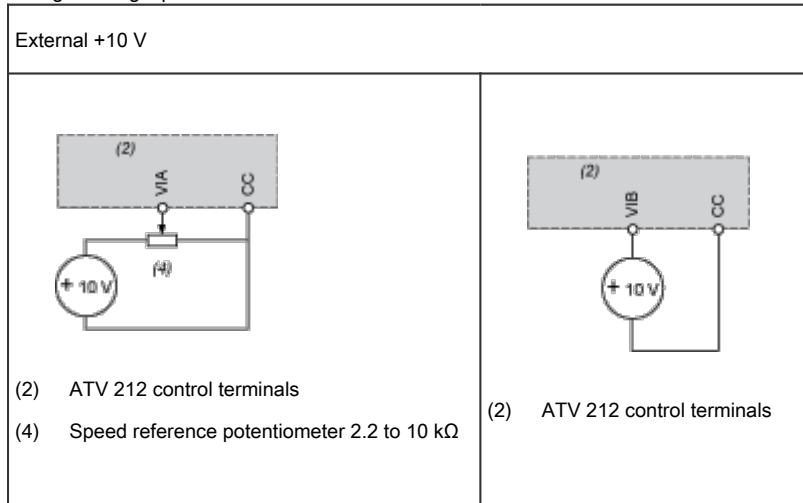

Analog input configured for current: 0-20 mA, 4-20 mA, X-Y mA

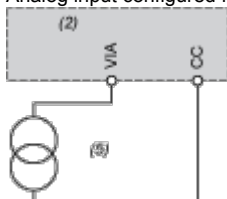

- (2) ATV 212 control terminals
- (5) Source 0-20 mA, 4-20 mA, X-Y mA

Analog input VIA configured as positive logic input (“Source” position)

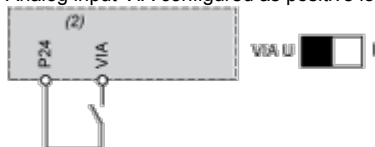

- (2) ATV 212 control terminals

Analog input VIA configured as negative logic input (“Sink” position)

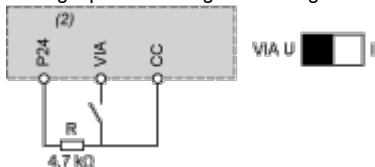

- (2) ATV 212 control terminals

Performance Curves

Derating Curves

The derating curves for the drive nominal current ( $I_n$ ) depend on the temperature, the switching frequency and the mounting type (A, B or C).

For intermediate temperatures (45°C for example), interpolate between 2 curves.

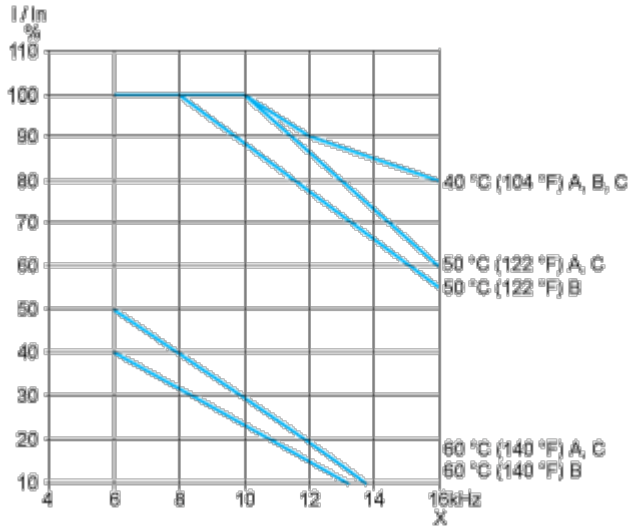

X Switching frequency