

19. Quad-Rings®/X-Rings

The sealing principle of the Quad-Ring®/X-Ring is nearly the same as the O-ring sealing. The initial sealing is achieved by the diametrical squeeze in a right angled groove. The system pressure itself creates a positive sealing force.

Following are some advantages of Quad-Rings®/X-Rings:

- With Quad-Rings®/X-Rings the standard grooves are deeper in comparison with O-ring glands. So the diametrical squeeze is lower than with O-rings. This makes dynamic sealing possible with reduced friction.
- The four lips of the Quad-Ring®/X-Ring create more sealing capacity and at the same time a groove for lubrication, which is very favorable for dynamic sealing.
- The most important advantage of the Quad-Ring®/X-Ring is the high stability for dynamic applications. In the situation that an O-ring rolls in the groove and creates torsion, a Quad-Ring®/X-Ring will slide with no negative results.
- More resistant to spiral failure.

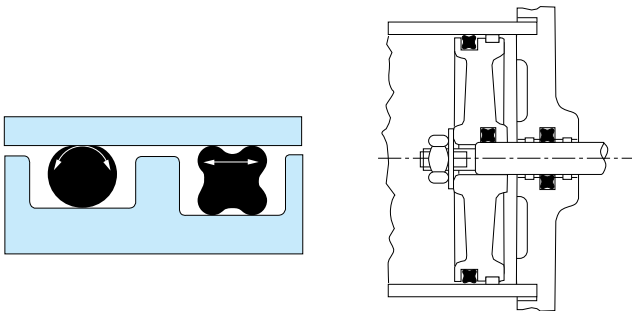

Standard cross sections of Quad-Rings®/X-Rings

Application Range from vacuum to 6000 psi (400 bar, 40 MPa.).
Over 750 psi (50 bar, 5 MPa.) when used in connection with back-up-rings.

Speeds up to 1.6 ft/s (0.5 m/sec.) (reciprocating).

Surface finish is the same as with O-ring applications.

See page 7.

The temperature range is from -50°C up to +200°C (-60°F up to +400°F) depending on the elastomer or compound. As with O-rings, many Quad-Rings®/X-Rings are manufactured according to the American Standards with inch dimensions and AS. numbers. To order Quad-Rings®/X-Rings, add a "4" as a prefix to the O-ring's number.

Note 1:

It is recommended, especially for dynamic seals, to use the Quad-Ring®/X-Ring with the largest possible cross section or thickness because thicker rings can withstand more tolerance variance.

A 4-inch I.D. (100 mm) Quad-Ring®/X-Ring is available with cross sections of .070 (1,78 mm), .103 (2,62 mm), .139 (3,53 mm), and .210 (5,33 mm). For dynamic applications use, if there is room, the largest cross section available (.210 / 5,33 mm).

Note 2:

Because Quad-Ring®/X-Ring glands have deeper grooves than O-rings, standard O-ring back-up rings cannot be used. The actual groove dimensions are needed to supply the correct sized machined back-up ring.

Note 3:

Use FKM Quad-Rings®/X-Rings with minimum stretch because FKM Quad-Rings®/X-Rings have a smaller tolerance range than NBR Quad-Rings®/X-Rings.



.070
(1,78 mm)



.103
(2,62 mm)



.139
(3,53 mm)



.210
(5,33 mm)

19. A. Gland Designs for Quad-Rings®/X-Rings

Dynamic Applications with Quad-Rings®/X-Rings

Spiral failure sometimes occurs on reciprocating O-rings. The conditions which cause this type of failure are those which cause segments of the O-ring to slide and other segments to roll simultaneously. The twisted seal is forced by the pressure into the sharp corner at the clearance gap. Rapid stress-aging can cause a rupture of the O-ring to start adjacent to the clearance gap. Motion of the O-ring causes the rupture to penetrate about half way through the cross section. Thus, when the O-ring is removed from the gland, it returns to its original shape and the rupture appears as a tight spiral around the cross section. One of the primary causes of spiral failure is by reciprocating speeds of less than one foot (0,3 m) per minute and on low or balanced pressure components. At this low speed, the sliding, or running, seal friction is very high relative to the break-out friction.

Therefore O-ring seals are not recommended for speeds less than 1 foot (0,3 m) per minute when the pressure difference is less than 400 psi (27,5 bar). A good solution to avoid spiral failure is the use of Quad-Rings®/X-Rings.

Quad-Rings®/X-Rings are used in many dynamic applications where O-rings provide less than satisfactory performance. The Quad-Ring®/X-Ring is a four lobed seal. They are designed for improved seal lubrication and to prevent rolling of the seal, or spiral failure.

Quad-Rings®/X-Rings are dimensionally the same size corresponding to US standard AS568 O-ring numbers. Groove dimensions for the Quad-Rings®/X-Rings are slightly different however, as less squeeze is required on the seal. Less squeeze means less friction and less wear on the seal.

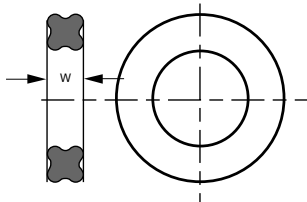

Fig. 1-36

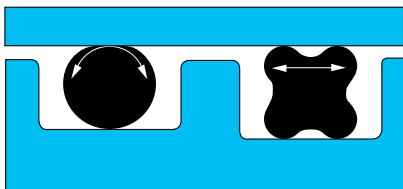

Fig. 1-37

19. A. Gland Designs for Quad-Rings®/X-Rings

Quad-Rings®/X-Rings Gland Design Static/Dynamic (INCHES)

The following table shows the groove dimensions for Quad-Rings®/X-Rings.

- If the Quad-Ring®/X-Ring swells in the application, the groove width can be enlarged up to 15% max.
- For the Quad-Rings®/X-Rings not listed, the groove dimensions are available upon request.

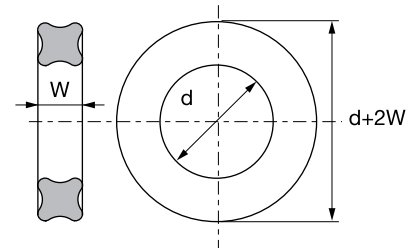
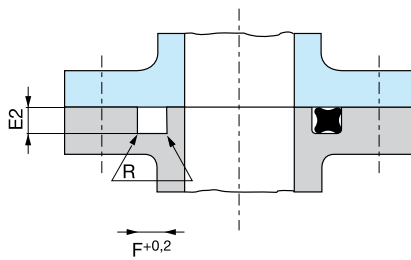
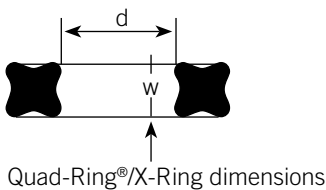
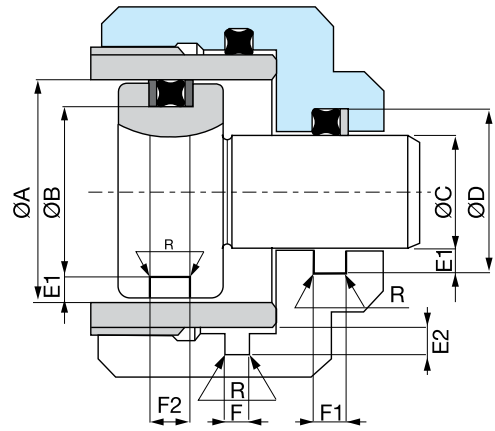

Table AS.8A Gland Dimensions (inches)

Quad-Ring® / X-Ring Size	Cross section *** W	Depth		Width **			Radius R	Max. Ø Clearance S max.
		Dynamic E1	Static E2	No backup ring F+ .008	With Backup ring F1+ .008	With Backup ring F2+ .008		
4001	.040 ± .003	.031 ± .001	.030 ± .001	.047	-	-	.004	.002
4002	.050 ± .003	.039 ± .001	.035 ± .001	.055	-	-	.006	.002
4003	.060 ± .003	.051 ± .001	.047 ± .001	.067	-	-	.010	.003
4003 1/2	.040 ± .003	.031 ± .001	.030 ± .001	.047	-	-	.004	.002
4004 - 4050	.070 ± .003	.061 ± .001	.056 ± .001	.080	.140	.200	.010	.004
4102 - 4178	.103 ± .003	.094 ± .001	.089 ± .001	.115	.170	.230	.015	.006
4201 - 4284	.139 ± .004	.128 ± .001	.122 ± .001	.155	.210	.270	.015	.006
4309 - 4395	.210 ± .005	.196 ± .001	.188 ± .001	.240	.310	.375	.020	.008
4425 - 4475	.275 ± .006	.256 ± .001	.244 ± .001	.310	.410	.510	.020	.008

Note:

(**) In case of exceptional bending of the rod or shaft, the diameter of the bottom of the groove can be adjusted both in case of vacuum and high pressure.

(***) Similar to O-rings, the Quad-Rings®/X-Rings need a squeeze of 10 to 15%. For critical applications in combination with small cross sections it is recommended to compare squeeze with the actual dimensions and tolerances.

19. A. Gland Designs for Quad-Rings®/X-Rings

Quad-Rings®/X-Rings Gland Design Static/Dynamic (METRIC)

The following table shows the groove dimensions for Quad-Rings®/X-Rings.

- If the Quad-Ring®/X-Ring swells in the application, the groove width can be enlarged up to 15% max.
- For the Quad-Rings®/X-Rings not listed, the groove dimensions are available upon request.

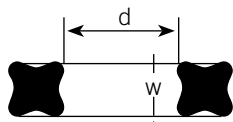
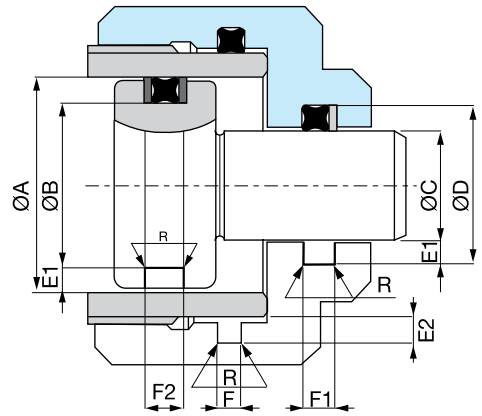

Quad-Ring®/X-Ring dimensions

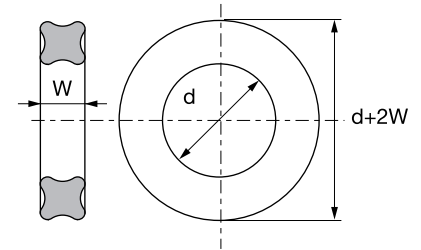
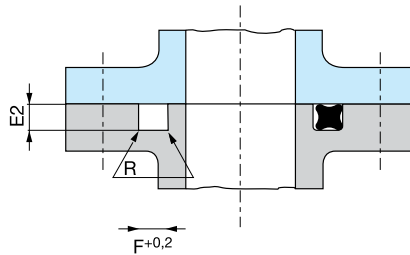

Table AS.8A Gland Dimensions (millimeters)

Quad-Ring® / X-Ring Size	Cross section *** W	Depth		Width **			Radius R	Max. Ø Clearance S max.
		Dynamic E1	Static E2	No backup ring F+ 0,2	With Backup ring F1+ 0,2	With Backup ring F2 + 0,2		
4001	1,02 + 0,08	0,8 + 0,025	0,75 + 0,025	1,2	-	-	0,1	0,05
4002	1,27 + 0,08	1,0 + 0,025	0,9 + 0,025	1,4	-	-	0,15	0,05
4003	1,52 + 0,08	1,3 + 0,025	1,2 + 0,025	1,7	-	-	0,25	0,08
4003 1/2	1,02 + 0,08	0,8 + 0,025	0,75 + 0,025	1,2	-	-	0,1	0,05
4004 - 4050	1,78 + 0,08	1,55 + 0,025	1,4 + 0,025	2,0	3,5	5,0	0,25	0,10
4102 - 4178	2,62 + 0,08	2,35 + 0,025	2,25 + 0,025	3,0	4,4	5,8	0,4	0,15
4201 - 4284	3,53 + 0,1	3,25 + 0,025	3,0 + 0,025	4,0	5,4	6,8	0,4	0,15
4309 - 4395	5,33 + 0,13	4,95 + 0,05	4,75 + 0,05	6,0	7,8	9,5	0,6	0,20
4425 - 4475	7,00 + 0,15	6,50 + 0,05	6,2 + 0,05	8,0	10,5	13,0	0,6	0,20

Other dimensions and elastomers are available upon request.

Note:

(**) In case of exceptional bending of the rod or shaft, the diameter of the bottom of the groove can be adjusted both in case of vacuum and high pressure.

(***) Similar to O-rings, the Quad-Rings®/X-Rings need a squeeze of 10 to 15%.

For critical applications in combination with small cross sections it is recommended to compare squeeze with the actual dimensions and tolerances.

19. B. Precision Quad-Rings®/X-Rings Standard Sizes

Nominal and Actual Dimensions

The following tables include nominal and actual dimensions, reflecting a slight built-in size reduction for effective sealing.

Tolerances

The standard seal tooling is dimensioned to the shrink characteristics of the standard NBR 70 hardness compound 36624. Because every rubber compound has its own shrink characteristics, slight deviations in dimensional tolerances will occur when standard seal tooling is used with materials other than the 36624 compound. The majority of the cases encountered involve rubber compounds with a higher shrink factor like a fluoroelastomer, resulting in an undersized seal. A slight adjustment in groove dimension may be required. Please contact the ERIKS Applications Engineers for tolerances when specifying materials other than the 36624 compound.

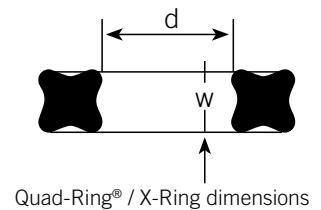

19. B. Precision Quad-Rings®/X-Rings Standard Sizes

Standard Quad-Ring® / X-Ring Sizes

Size Only		Nominal Sizes				Actual Sizes						
Part nr.	Rod	Bore	ID (in)	C/S (in)	ID (in)	+/-	ID(mm)	+/-	C/S (in)	+/-	C/S (mm)	+/-
4001	.031	.093	1/32	1/32	.029	.004	0,74	0,10	.040	.003	1,02	0,08
4002	.046	.125	3/64	3/64	.042	.004	1,07	0,10	.050	.003	1,27	0,08
4003	.062	.156	1/16	1/16	.056	.004	1,42	0,10	.060	.003	1,52	0,08
4003 1/2	.078	.141	1/16	1/32	.070	.004	1,78	0,10	.040	.003	1,02	0,08
4004	.078	.203	5/64	1/16	.070	.005	1,78	0,13	.070	.003	1,78	0,08
4005	.109	.234	3/32	1/16	.101	.005	2,57	0,13	.070	.003	1,78	0,08
4006	.125	.250	1/8	1/16	.114	.005	2,90	0,13	.070	.003	1,78	0,08
4007	.156	.281	5/32	1/16	.145	.005	3,68	0,13	.070	.003	1,78	0,08
4008	.187	.312	3/16	1/16	.176	.005	4,47	0,13	.070	.003	1,78	0,08
4009	.218	.343	7/32	1/16	.208	.005	5,28	0,13	.070	.003	1,78	0,08
4010	.250	.375	1/4	1/16	.239	.005	6,07	0,13	.070	.003	1,78	0,08
4011	.312	.437	5/16	1/16	.301	.005	7,65	0,13	.070	.003	1,78	0,08
4012	.375	.500	3/8	1/16	.364	.005	9,25	0,13	.070	.003	1,78	0,08
4013	.437	.562	7/16	1/16	.426	.005	10,82	0,13	.070	.003	1,78	0,08
4014	.500	.625	1/2	1/16	.489	.005	12,42	0,13	.070	.003	1,78	0,08
4015	.562	.687	9/16	1/16	.551	.007	14,00	0,18	.070	.003	1,78	0,08
4016	.625	.750	5/8	1/16	.614	.009	15,60	0,23	.070	.003	1,78	0,08
4017	.687	.812	11/16	1/16	.676	.009	17,17	0,23	.070	.003	1,78	0,08
4018	.750	.875	3/4	1/16	.739	.009	18,77	0,23	.070	.003	1,78	0,08
4019	.812	.937	13/16	1/16	.801	.009	20,35	0,23	.070	.003	1,78	0,08
4020	.875	1.000	7/8	1/16	.864	.009	21,95	0,23	.070	.003	1,78	0,08
4021	.937	1.062	15/16	1/16	.926	.009	23,52	0,23	.070	.003	1,78	0,08
4022	1.000	1.125	1	1/16	.989	.010	25,12	0,25	.070	.003	1,78	0,08
4023	1.062	1.187	1-1/16	1/16	1.051	.010	26,70	0,25	.070	.003	1,78	0,08
4024	1.125	1.250	1-1/8	1/16	1.114	.010	28,23	0,25	.070	.003	1,78	0,08
4025	1.187	1.312	1-3/16	1/16	1.176	.011	29,87	0,28	.070	.003	1,78	0,08
4026	1.250	1.375	1-1/4	1/16	1.239	.011	31,47	0,28	.070	.003	1,78	0,08
4027	1.312	1.437	1-5/16	1/16	1.301	.011	33,05	0,28	.070	.003	1,78	0,08
4028	1.375	1.500	1-3/8	1/16	1.364	.013	34,65	0,33	.070	.003	1,78	0,08
4029	1.500	1.625	1-1/2	1/16	1.489	.013	37,82	0,33	.070	.003	1,78	0,08
4030	1.625	1.750	1-5/8	1/16	1.614	.013	41,00	0,33	.070	.003	1,78	0,08
4031	1.750	1.875	1-3/4	1/16	1.739	.015	44,17	0,38	.070	.003	1,78	0,08
4032	1.875	2.000	1-7/8	1/16	1.864	.015	47,35	0,38	.070	.003	1,78	0,08
4033	2.000	2.125	2	1/16	1.989	.018	50,52	0,46	.070	.003	1,78	0,08
4034	2.125	2.250	2-1/8	1/16	2.114	.018	53,70	0,46	.070	.003	1,78	0,08
4035	2.250	2.375	2-1/4	1/16	2.239	.018	56,87	0,46	.070	.003	1,78	0,08
4036	2.375	2.500	2-3/8	1/16	2.364	.018	60,05	0,46	.070	.003	1,78	0,08
4037	2.500	2.625	2-1/2	1/16	2.489	.018	63,22	0,46	.070	.003	1,78	0,08
4038	2.625	2.750	2-5/8	1/16	2.614	.020	66,40	0,51	.070	.003	1,78	0,08
4039	2.750	2.875	2-3/4	1/16	2.739	.020	69,57	0,51	.070	.003	1,78	0,08
4040	2.875	3.000	2-7/8	1/16	2.864	.020	72,75	0,51	.070	.003	1,78	0,08
4041	3.000	3.125	3	1/16	2.989	.024	75,92	0,61	.070	.003	1,78	0,08
4042	3.250	3.375	3-1/4	1/16	3.239	.024	82,27	0,61	.070	.003	1,78	0,08
4043	3.500	3.625	3-1/2	1/16	3.489	.024	88,62	0,61	.070	.003	1,78	0,08
4044	3.750	3.875	3-3/4	1/16	3.739	.027	94,97	0,69	.070	.003	1,78	0,08
4045	4.000	4.125	4	1/16	3.989	.027	101,32	0,69	.070	.003	1,78	0,08
4046	4.250	4.375	4-1/4	1/16	4.239	.030	107,67	0,76	.070	.003	1,78	0,08
4047	4.500	4.625	4-3/4	1/16	4.489	.030	114,02	0,76	.070	.003	1,78	0,08
4048	4.750	4.875	4-3/4	1/16	4.739	.030	120,37	0,76	.070	.003	1,78	0,08
4049	5.000	5.125	5	1/16	4.989	.037	126,72	0,94	.070	.003	1,78	0,08
4050	5.250	5.375	5-1/4	1/16	5.239	.037	133,07	0,94	.070	.003	1,78	0,08

19. B. Precision Quad-Rings®/X-Rings Standard Sizes

Standard Quad-Ring® / X-Ring Sizes

Size Only Part nr.	Nominal Sizes				Actual Sizes							
	Rod	Bore	ID (in)	C/S (in)	ID (in)	+/-	ID(mm)	+/-	C/S (in)	+/-	C/S (mm)	+/-
4102	.062	.250	1/16	3/32	.049	.005	1,24	0,13	.103	.003	2,62	0,08
4103	.094	.281	3/32	3/32	.081	.005	2,06	0,13	.103	.003	2,62	0,08
4104	.125	.312	1/8	3/32	.112	.005	2,85	0,13	.103	.003	2,62	0,08
4105	.156	.343	5/32	3/32	.143	.005	3,63	0,13	.103	.003	2,62	0,08
4106	.187	.375	3/16	3/32	.174	.005	4,42	0,13	.103	.003	2,62	0,08
4107	.219	.406	7/32	3/32	.206	.005	5,23	0,13	.103	.003	2,62	0,08
4108	.250	.437	1/4	3/32	.237	.005	6,02	0,13	.103	.003	2,62	0,08
4109	.312	.500	5/16	3/32	.299	.005	7,60	0,13	.103	.003	2,62	0,08
4110	.375	.562	3/8	3/32	.362	.005	9,20	0,13	.103	.003	2,62	0,08
4111	.437	.625	7/16	3/32	.424	.005	10,77	0,13	.103	.003	2,62	0,08
4112	.500	.687	1/2	3/32	.487	.005	12,37	0,13	.103	.003	2,62	0,08
4113	.562	.750	9/16	3/32	.549	.007	13,95	0,18	.103	.003	2,62	0,08
4114	.625	.812	5/8	3/32	.612	.009	15,55	0,23	.103	.003	2,62	0,08
4115	.687	.875	11/16	3/32	.674	.009	17,12	0,23	.103	.003	2,62	0,08
4116	.750	.937	3/4	3/32	.737	.009	18,72	0,25	.103	.003	2,62	0,08
4117	.812	1.000	13/16	3/32	.799	.010	20,30	0,25	.103	.003	2,62	0,08
4118	.875	1.062	7/8	3/32	.862	.010	21,90	0,25	.103	.003	2,62	0,08
4119	.937	1.125	15/16	3/32	.924	.010	23,47	0,25	.103	.003	2,62	0,08
4120	1.000	1.187	1	3/32	.987	.010	25,07	0,25	.103	.003	2,62	0,08
4121	1.062	1.250	1-1/16	3/32	1.049	.010	26,65	0,25	.103	.003	2,62	0,08
4122	1.125	1.312	1-1/8	3/32	1.112	.010	28,25	0,25	.103	.003	2,62	0,08
4123	1.187	1.375	1-3/16	3/32	1.174	.012	29,82	0,31	.103	.003	2,62	0,08
4124	1.250	1.437	1-1/4	3/32	1.237	.012	31,42	0,31	.103	.003	2,62	0,08
4125	1.312	1.500	1-5/16	3/32	1.299	.012	33,00	0,31	.103	.003	2,62	0,08
4126	1.375	1.562	1-3/8	3/32	1.362	.012	34,60	0,31	.103	.003	2,62	0,08
4127	1.437	1.625	1-7/16	3/32	1.424	.012	36,17	0,31	.103	.003	2,62	0,08
4128	1.500	1.687	1-1/2	3/32	1.487	.012	37,77	0,31	.103	.003	2,62	0,08
4129	1.562	1.750	1-9/16	3/32	1.549	.015	39,35	0,38	.103	.003	2,62	0,08
4130	1.625	1.812	1-5/8	3/32	1.612	.015	41,00	0,38	.103	.003	2,62	0,08
4131	1.687	1.875	1-11/16	3/32	1.674	.015	42,52	0,38	.103	.003	2,62	0,08
4132	1.750	1.937	1-3/4	3/32	1.737	.015	44,12	0,38	.103	.003	2,62	0,08
4133	1.812	2.000	1-13/16	3/32	1.799	.015	45,70	0,38	.103	.003	2,62	0,08
4134	1.875	2.062	1-7/8	3/32	1.862	.015	47,30	0,38	.103	.003	2,62	0,08
4135	1.938	2.125	1-15/16	3/32	1.925	.017	48,90	0,43	.103	.003	2,62	0,08
4136	2.000	2.187	2	3/32	1.987	.017	50,47	0,43	.103	.003	2,62	0,08
4137	2.063	2.250	2-1/16	3/32	2.050	.017	52,07	0,43	.103	.003	2,62	0,08
4138	2.125	2.312	2-1/8	3/32	2.112	.017	53,65	0,43	.103	.003	2,62	0,08
4139	2.188	2.375	2-3/16	3/32	2.175	.017	55,25	0,43	.103	.003	2,62	0,08
4140	2.250	2.437	2-1/4	3/32	2.237	.017	56,82	0,43	.103	.003	2,62	0,08
4141	2.313	2.500	2-6/16	3/32	2.300	.020	58,42	0,51	.103	.003	2,62	0,08
4142	2.375	2.562	2-3/8	3/32	2.362	.020	60,00	0,51	.103	.003	2,62	0,08
4143	2.438	2.625	2-7/16	3/32	2.425	.020	61,60	0,51	.103	.003	2,62	0,08
4144	2.500	2.687	2-1/2	3/32	2.487	.020	63,17	0,51	.103	.003	2,62	0,08
4145	2.563	2.750	2-9/16	3/32	2.550	.020	64,77	0,51	.103	.003	2,62	0,08
4146	2.625	2.812	2-5/8	3/32	2.612	.020	66,34	0,51	.103	.003	2,62	0,08
4147	2.688	2.875	2-11/16	3/32	2.675	.022	67,95	0,56	.103	.003	2,62	0,08
4148	2.750	2.937	2-3/4	3/32	2.737	.022	69,52	0,56	.103	.003	2,62	0,08
4149	2.813	3.000	2-13/16	3/32	2.800	.022	71,12	0,56	.103	.003	2,62	0,08
4150	2.875	3.062	2-7/8	3/32	2.862	.022	72,70	0,56	.103	.003	2,62	0,08
4151	3.000	3.187	3	3/32	2.987	.024	75,87	0,61	.103	.003	2,62	0,08
4152	3.250	3.437	3-1/4	3/32	3.237	.024	82,22	0,61	.103	.003	2,62	0,08

19. B. Precision Quad-Rings®/X-Rings Standard Sizes

Standard Quad-Ring® / X-Ring Sizes

Size Only Part nr.	Nominal Sizes				Actual Sizes							
	Rod	Bore	ID (in)	C/S (in)	ID (in)	+/-	ID(mm)	+/-	C/S (in)	+/-	C/S (mm)	+/-
4153	3.500	3.687	3-1/2	3/32	3.487	.024	88,57	0,61	.103	.003	2,62	0,08
4154	3.750	3.937	3-3/4	3/32	3.737	.028	94,92	0,71	.103	.003	2,62	0,08
4155	4.000	4.187	4	3/32	3.987	.028	101,27	0,71	.103	.003	2,62	0,08
4156	4.250	4.437	4-1/4	3/32	4.237	.030	107,62	0,76	.103	.003	2,62	0,08
4157	4.500	4.687	4-1/2	3/32	4.487	.030	113,97	0,76	.103	.003	2,62	0,08
4158	4.750	4.937	4-3/4	3/32	4.737	.030	120,32	0,76	.103	.003	2,62	0,08
4159	5.000	5.187	5	3/32	4.987	.035	126,67	0,89	.103	.003	2,62	0,08
4160	5.250	5.437	5-1/4	3/32	5.237	.035	133,02	0,89	.103	.003	2,62	0,08
4161	5.500	5.687	5-1/2	3/32	5.487	.035	139,37	0,89	.103	.003	2,62	0,08
4162	5.750	5.937	5-3/4	3/32	5.737	.035	145,72	0,89	.103	.003	2,62	0,08
4163	6.000	6.187	6	3/32	5.987	.035	152,07	0,89	.103	.003	2,62	0,08
4164	6.250	6.437	6-1/4	3/32	6.237	.040	158,42	1,02	.103	.003	2,62	0,08
4165	6.500	6.687	6-1/2	3/32	6.487	.040	164,77	1,02	.103	.003	2,62	0,08
4166	6.750	6.937	6-3/4	3/32	6.737	.040	171,12	1,02	.103	.003	2,62	0,08
4167	7.000	7.187	7	3/32	6.987	.040	177,47	1,02	.103	.003	2,62	0,08
4168	7.250	7.437	7-1/4	3/32	7.237	.045	183,82	1,14	.103	.003	2,62	0,08
4169	7.500	7.687	7-1/2	3/32	7.487	.045	190,17	1,14	.103	.003	2,62	0,08
4170	7.750	7.937	7-3/4	3/32	7.737	.045	196,52	1,14	.103	.003	2,62	0,08
4171	8.000	8.187	8	3/32	7.987	.045	202,87	1,14	.103	.003	2,62	0,08
4172	8.250	8.437	8-1/4	3/32	8.237	.050	209,22	1,27	.103	.003	2,62	0,08
4173	8.500	8.687	8-1/2	3/32	8.487	.050	215,57	1,27	.103	.003	2,62	0,08
4174	8.750	8.937	8-3/4	3/32	8.737	.050	221,92	1,27	.103	.003	2,62	0,08
4175	9.000	9.187	9	3/32	8.987	.050	228,27	1,27	.103	.003	2,62	0,08
4176	9.250	9.437	9-1/4	3/32	9.237	.055	234,62	1,40	.103	.003	2,62	0,08
4177	9.500	9.687	9-1/2	3/32	9.487	.055	240,97	1,40	.103	.003	2,62	0,08
4178	9.750	9.937	9-3/4	3/32	9.737	.055	247,32	1,40	.103	.003	2,62	0,08
4201	.187	.437	3/16	1/8	.171	.005	4,34	0,13	.139	.004	3,53	0,10
4202	.250	.500	1/4	1/8	.234	.005	5,94	0,13	.139	.004	3,53	0,10
4203	.312	.562	5/16	1/8	.296	.005	7,52	0,13	.139	.004	3,53	0,10
4204	.375	.625	3/8	1/8	.359	.005	9,12	0,13	.139	.004	3,53	0,10
4205	.437	.687	7/16	1/8	.421	.005	10,69	0,13	.139	.004	3,53	0,10
4206	.500	.750	1/2	1/8	.484	.005	12,29	0,13	.139	.004	3,53	0,10
4207	.562	.812	9/16	1/8	.546	.007	13,87	0,18	.139	.004	3,53	0,10
4208	.625	.875	5/8	1/8	.609	.009	15,47	0,23	.139	.004	3,53	0,10
4209	.687	.937	11/16	1/8	.671	.009	17,04	0,23	.139	.004	3,53	0,10
4210	.750	1.000	3/4	1/8	.734	.010	18,64	0,25	.139	.004	3,53	0,10
4211	.812	1.062	13/16	1/8	.796	.010	20,22	0,25	.139	.004	3,53	0,10
4212	.875	1.125	7/8	1/8	.859	.010	21,82	0,25	.139	.004	3,53	0,10
4213	.937	1.187	15/16	1/8	.921	.010	23,39	0,25	.139	.004	3,53	0,10
4214	1.000	1.250	1	1/8	.984	.010	24,99	0,25	.139	.004	3,53	0,10
4215	1.062	1.312	1-1/16	1/8	1.046	.010	26,57	0,25	.139	.004	3,53	0,10
4216	1.125	1.375	1-1/8	1/8	1.109	.012	28,17	0,31	.139	.004	3,53	0,10
4217	1.187	1.437	1-3/16	1/8	1.171	.012	29,74	0,31	.139	.004	3,53	0,10
4218	1.250	1.500	1-1/4	1/8	1.234	.012	31,34	0,31	.139	.004	3,53	0,10
4219	1.312	1.562	1-5/16	1/8	1.296	.012	32,92	0,31	.139	.004	3,53	0,10
4220	1.375	1.625	1-3/8	1/8	1.359	.012	34,52	0,31	.139	.004	3,53	0,10
4221	1.437	1.687	1-7/16	1/8	1.421	.012	36,09	0,31	.139	.004	3,53	0,10
4222	1.500	1.750	1-1/2	1/8	1.484	.015	37,69	0,38	.139	.004	3,53	0,10
4223	1.625	1.875	1-5/8	1/8	1.609	.015	40,87	0,38	.139	.004	3,53	0,10
4224	1.750	2.000	1-3/4	1/8	1.734	.015	44,04	0,38	.139	.004	3,53	0,10

19. B. Precision Quad-Rings®/X-Rings Standard Sizes

Standard Quad-Ring® / X-Ring Sizes

Size Only		Nominal Sizes				Actual Sizes						
Part nr.	Rod	Bore	ID (in)	C/S (in)	ID (in)	+/-	ID(mm)	+/-	C/S (in)	+/-	C/S (mm)	+/-
4225	1.875	2.125	1-7/8	1/8	1.859	.018	47,22	0,46	.139	.004	3,53	0,10
4226	2.000	2.250	2	1/8	1.984	.018	50,39	0,46	.139	.004	3,53	0,10
4227	2.125	2.675	2-1/8	1/8	2.109	.018	53,57	0,46	.139	.004	3,53	0,10
4228	2.250	2.500	2-1/4	1/8	2.234	.020	56,74	0,51	.139	.004	3,53	0,10
4229	2.375	2.625	2-3/8	1/8	2.359	.020	59,92	0,51	.139	.004	3,53	0,10
4230	2.500	2.750	2-1/2	1/8	2.484	.020	63,09	0,51	.139	.004	3,53	0,10
4231	2.625	2.875	2-5/8	1/8	2.609	.020	66,27	0,51	.139	.004	3,53	0,10
4232	2.750	3.000	2-3/4	1/8	2.734	.024	69,44	0,61	.139	.004	3,53	0,10
4233	2.875	3.125	2-7/8	1/8	2.859	.024	72,62	0,61	.139	.004	3,53	0,10
4234	3.000	3.250	3	1/8	2.984	.024	75,79	0,61	.139	.004	3,53	0,10
4235	3.125	3.375	3-1/8	1/8	3.109	.024	78,97	0,61	.139	.004	3,53	0,10
4236	3.250	3.500	3-1/4	1/8	3.234	.024	82,14	0,61	.139	.004	3,53	0,10
4237	3.375	3.625	3-3/8	1/8	3.359	.024	85,32	0,61	.139	.004	3,53	0,10
4238	3.500	2.750	3-1/2	1/8	3.484	.024	88,49	0,61	.139	.004	3,53	0,10
4239	3.625	3.875	3-5/8	1/8	3.609	.028	91,67	0,71	.139	.004	3,53	0,10
4240	3.750	4.000	3-3/4	1/8	3.734	.028	94,84	0,71	.139	.004	3,53	0,10
4241	3.875	4.125	3-7/8	1/8	3.859	.028	98,02	0,71	.139	.004	3,53	0,10
4242	4.000	4.250	4	1/8	3.984	.028	101,19	0,71	.139	.004	3,53	0,10
4243	4.125	4.375	4-1/8	1/8	4.109	.028	104,37	0,71	.139	.004	3,53	0,10
4244	4.250	4.500	4-1/4	1/8	4.234	.030	107,54	0,76	.139	.004	3,53	0,10
4245	4.375	4.625	4-3/8	1/8	4.359	.030	110,72	0,76	.139	.004	3,53	0,10
4246	4.500	4.750	4-1/2	1/8	4.484	.030	113,89	0,76	.139	.004	3,53	0,10
4247	4.625	4.875	4-5/8	1/8	4.609	.030	117,07	0,76	.139	.004	3,53	0,10
4248	4.750	5.000	4-3/4	1/8	4.734	.030	120,24	0,76	.139	.004	3,53	0,10
4249	4.875	5.125	4-7/8	1/8	4.859	.035	123,42	0,89	.139	.004	3,53	0,10
4250	5.000	5.250	5	1/8	4.984	.035	126,59	0,89	.139	.004	3,53	0,10
4251	5.125	5.375	5-1/8	1/8	5.109	.035	129,77	0,89	.139	.004	3,53	0,10
4252	5.250	5.500	5-1/4	1/8	5.234	.035	132,94	0,89	.139	.004	3,53	0,10
4253	5.375	5.625	5-3/8	1/8	5.359	.035	136,12	0,89	.139	.004	3,53	0,10
4254	5.500	5.750	5-1/2	1/8	5.484	.035	139,29	0,89	.139	.004	3,53	0,10
4255	5.625	5.875	5-5/8	1/8	5.609	.035	142,47	0,89	.139	.004	3,53	0,10
4256	5.750	6.000	5-3/4	1/8	5.734	.035	145,64	0,89	.139	.004	3,53	0,10
4257	5.875	6.125	5-7/8	1/8	5.859	.035	148,82	0,89	.139	.004	3,53	0,10
4258	6.000	6.250	6	1/8	5.984	.035	151,99	0,89	.139	.004	3,53	0,10
4259	6.250	6.500	6-1/4	1/8	6.234	.040	158,34	1,02	.139	.004	3,53	0,10
4260	6.500	6.750	6-1/2	1/8	6.484	.040	164,69	1,02	.139	.004	3,53	0,10
4261	6.750	7.000	6-3/4	1/8	6.734	.040	171,04	1,02	.139	.004	3,53	0,10
4262	7.000	7.250	7	1/8	6.984	.040	177,39	1,02	.139	.004	3,53	0,10
4263	7.250	7.500	7-1/4	1/8	7.234	.045	183,74	1,14	.139	.004	3,53	0,10
4264	7.500	7.750	7-1/2	1/8	7.484	.045	190,10	1,14	.139	.004	3,53	0,10
4265	7.750	8.000	7-3/4	1/8	7.734	.045	196,44	1,14	.139	.004	3,53	0,10
4266	8.000	8.250	8	1/8	7.984	.045	202,79	1,14	.139	.004	3,53	0,10
4267	8.250	8.500	8-1/4	1/8	8.234	.050	209,14	1,27	.139	.004	3,53	0,10
4268	8.500	8.750	8-1/2	1/8	8.484	.050	215,49	1,27	.139	.004	3,53	0,10
4269	8.750	9.000	8-3/4	1/8	8.734	.050	221,84	1,27	.139	.004	3,53	0,10
4270	9.000	9.250	9	1/8	8.984	.050	228,19	1,27	.139	.004	3,53	0,10
4271	9.250	9.500	9-1/4	1/8	9.234	.055	234,54	1,40	.139	.004	3,53	0,10
4272	9.500	9.750	9-1/2	1/8	9.484	.055	240,89	1,40	.139	.004	3,53	0,10
4273	9.750	10.000	9-3/4	1/8	9.734	.055	247,24	1,40	.139	.004	3,53	0,10
4274	10.000	10.250	10	1/8	9.984	.055	253,59	1,40	.139	.004	3,53	0,10
4275	10.500	10.750	10-1/2	1/8	10.484	.055	266,29	1,40	.139	.004	3,53	0,10

19. B. Precision Quad-Rings®/X-Rings Standard Sizes

Standard Quad-Ring® / X-Ring Sizes

Size Only Part nr.	Nominal Sizes				Actual Sizes							
	Rod	Bore	ID (in)	C/S (in)	ID (in)	+/-	ID(mm)	+/-	C/S (in)	+/-	C/S (mm)	+/-
4276	11.000	11.250	11	1/8	10.984	.065	278,99	1,65	.139	.004	3,53	0,10
4277	11.500	11.750	11-1/2	1/8	11.484	.065	291,69	1,65	.139	.004	3,53	0,10
4278	12.000	12.250	12	1/8	11.984	.065	304,39	1,65	.139	.004	3,53	0,10
4279	13.000	13.250	13	1/8	12.984	.065	329,79	1,65	.139	.004	3,53	0,10
4280	14.000	14.250	14	1/8	13.984	.065	355,19	1,65	.139	.004	3,53	0,10
4281	15.000	15.250	15	1/8	14.984	.065	380,59	1,65	.139	.004	3,53	0,10
4282	16.000	16.250	16	1/8	15.955	.075	405,26	1,91	.139	.004	3,53	0,10
4283	17.000	17.250	17	1/8	16.955	.080	430,66	2,03	.139	.004	3,53	0,10
4284	18.000	18.250	18	1/8	17.955	.085	456,06	2,16	.139	.004	3,53	0,10
4309	.437	.812	7/16	3/16	.412	.005	10,47	0,13	.210	.005	5,33	0,13
4310	.500	.875	1/2	3/16	.475	.005	12,07	0,13	.210	.005	5,33	0,13
4311	.562	.937	9/16	3/16	.537	.007	13,64	0,18	.210	.005	5,33	0,13
4312	.625	1.000	5/8	3/16	.600	.009	15,24	0,23	.210	.005	5,33	0,13
4313	.687	1.062	11/16	3/16	.662	.009	16,82	0,23	.210	.005	5,33	0,13
4314	.750	1.125	3/4	3/16	.725	.010	18,42	0,25	.210	.005	5,33	0,13
4315	.812	1.187	13/16	3/16	.787	.010	19,99	0,25	.210	.005	5,33	0,13
4316	.875	1.250	7/8	3/16	.850	.010	21,59	0,25	.210	.005	5,33	0,13
4317	.937	1.312	15/16	3/16	.912	.010	23,17	0,25	.210	.005	5,33	0,13
4318	1.000	1.375	1	3/16	.975	.010	24,77	0,25	.210	.005	5,33	0,13
4319	1.062	1.437	1-1/16	3/16	1.037	.010	26,34	0,25	.210	.005	5,33	0,13
4320	1.125	1.500	1-1/8	3/16	1.100	.012	27,94	0,31	.210	.005	5,33	0,13
4321	1.187	1.562	1-3/16	3/16	1.162	.012	29,52	0,31	.210	.005	5,33	0,13
4322	1.250	1.625	1-1/4	3/16	1.225	.012	31,12	0,31	.210	.005	5,33	0,13
4323	1.312	1.687	1-5/16	3/16	1.287	.012	32,69	0,31	.210	.005	5,33	0,13
4324	1.375	1.750	1-3/8	3/16	1.350	.012	34,29	0,31	.210	.005	5,33	0,13
4325	1.500	1.875	1-1/2	3/16	1.475	.015	37,47	0,38	.210	.005	5,33	0,13
4326	1.625	2.000	1-5/8	3/16	1.600	.015	40,64	0,38	.210	.005	5,33	0,13
4327	1.750	2.125	1-3/4	3/16	1.725	.015	43,82	0,38	.210	.005	5,33	0,13
4328	1.875	2.250	1-7/8	3/16	1.850	.015	46,99	0,38	.210	.005	5,33	0,13
4329	2.000	2.375	2	3/16	1.975	.018	50,17	0,46	.210	.005	5,33	0,13
4330	2.125	2.500	2-1/8	3/16	2.100	.018	53,34	0,46	.210	.005	5,33	0,13
4331	2.250	2.625	2-1/4	3/16	2.225	.018	56,52	0,46	.210	.005	5,33	0,13
4332	2.375	2.750	2-3/8	3/16	2.350	.018	59,69	0,46	.210	.005	5,33	0,13
4333	2.500	2.875	2-1/2	3/16	2.475	.020	62,87	0,51	.210	.005	5,33	0,13
4334	2.625	3.000	2-5/8	3/16	2.600	.020	66,04	0,51	.210	.005	5,33	0,13
4335	2.750	3.125	2-3/4	3/16	2.725	.020	69,22	0,51	.210	.005	5,33	0,13
4336	2.875	3.250	2-7/8	3/16	2.850	.020	72,39	0,51	.210	.005	5,33	0,13
4337	3.000	3.375	3	3/16	2.975	.024	75,57	0,61	.210	.005	5,33	0,13
4338	3.125	3.500	3-1/8	3/16	3.100	.024	78,74	0,61	.210	.005	5,33	0,13
4339	3.250	3.625	3-1/4	3/16	3.225	.024	81,92	0,61	.210	.005	5,33	0,13
4340	3.375	3.750	3-3/8	3/16	3.350	.024	85,09	0,61	.210	.005	5,33	0,13
4341	3.500	3.875	3-1/2	3/16	3.475	.024	88,27	0,61	.210	.005	5,33	0,13
4342	3.625	4.000	3-5/8	3/16	3.600	.028	91,44	0,71	.210	.005	5,33	0,13
4343	3.750	4.125	3-3/4	3/16	3.725	.028	94,62	0,71	.210	.005	5,33	0,13
4344	3.875	4.250	3-7/8	3/16	3.850	.028	97,79	0,71	.210	.005	5,33	0,13
4345	4.000	4.375	4	3/16	3.975	.028	100,97	0,71	.210	.005	5,33	0,13
4346	4.125	4.500	4-1/8	3/16	4.100	.028	104,14	0,71	.210	.005	5,33	0,13
4347	4.250	4.625	4-1/4	3/16	4.225	.030	107,32	0,76	.210	.005	5,33	0,13
4348	4.375	4.750	4-3/8	3/16	4.350	.030	110,49	0,76	.210	.005	5,33	0,13
4349	4.500	4.875	4-1/2	3/16	4.475	.030	113,67	0,76	.210	.005	5,33	0,13

19. B. Precision Quad-Rings®/X-Rings Standard Sizes

Standard Quad-Ring® / X-Ring Sizes

Size Only Part nr.	Nominal Sizes				Actual Sizes							
	Rod	Bore	ID (in)	C/S (in)	ID (in)	+/-	ID(mm)	+/-	C/S (in)	+/-	C/S (mm)	+/-
4350	4.625	5.000	4-5/8	3/16	4.600	.030	116,84	0,76	.210	.005	5,33	0,13
4351	4.750	5.125	4-3/4	3/16	4.725	.030	120,02	0,76	.210	.005	5,33	0,13
4352	4.875	5.250	4-7/8	3/16	4.850	.030	123,19	0,76	.210	.005	5,33	0,13
4353	5.000	5.375	5	3/16	4.975	.037	126,37	0,94	.210	.005	5,33	0,13
4354	5.125	5.500	5-1/8	3/16	5.100	.037	129,54	0,94	.210	.005	5,33	0,13
4355	5.250	5.625	5-1/4	3/16	5.225	.037	132,72	0,94	.210	.005	5,33	0,13
4356	5.375	5.750	5-3/8	3/16	5.350	.037	135,89	0,94	.210	.005	5,33	0,13
4357	5.500	5.875	5-1/2	3/16	5.475	.037	139,07	0,94	.210	.005	5,33	0,13
4358	5.625	6.000	5-5/8	3/16	5.600	.037	142,24	0,94	.210	.005	5,33	0,13
4359	5.750	6.125	5-3/4	3/16	5.725	.037	145,42	0,94	.210	.005	5,33	0,13
4360	5.875	6.250	5-7/8	3/16	5.850	.037	148,59	0,94	.210	.005	5,33	0,13
4361	6.000	6.375	6	3/16	5.975	.037	151,77	0,94	.210	.005	5,33	0,13
4362	6.250	6.625	6-1/4	3/16	6.225	.040	158,12	1,02	.210	.005	5,33	0,13
4363	6.500	6.875	6-1/2	3/16	6.475	.040	164,47	1,02	.210	.005	5,33	0,13
4364	6.750	7.125	6-3/4	3/16	6.725	.040	170,82	1,02	.210	.005	5,33	0,13
4365	7.000	7.375	7	3/16	6.975	.040	177,17	1,02	.210	.005	5,33	0,13
4366	7.250	7.625	7-1/4	3/16	7.225	.045	183,52	1,14	.210	.005	5,33	0,13
4367	7.500	7.875	7-1/2	3/16	7.475	.045	189,87	1,14	.210	.005	5,33	0,13
4368	7.750	8.125	7-3/4	3/16	7.725	.045	196,22	1,14	.210	.005	5,33	0,13
4369	8.000	8.375	8	3/16	7.975	.045	202,57	1,14	.210	.005	5,33	0,13
4370	8.250	8.625	8-1/4	3/16	8.225	.050	208,92	1,27	.210	.005	5,33	0,13
4371	8.500	8.875	8-1/2	3/16	8.475	.050	215,27	1,27	.210	.005	5,33	0,13
4372	8.750	9.125	8-3/4	3/16	8.725	.050	221,62	1,27	.210	.005	5,33	0,13
4373	9.000	9.375	9	3/16	8.975	.050	227,97	1,27	.210	.005	5,33	0,13
4374	9.250	9.625	9-1/4	3/16	9.225	.055	234,32	0,14	.210	.005	5,33	0,13
4375	9.500	9.875	9-1/2	3/16	9.475	.055	240,67	0,14	.210	.005	5,33	0,13
4376	9.750	10.125	9-3/4	3/16	9.725	.055	247,02	0,14	.210	.005	5,33	0,13
4377	10.000	10.375	10	3/16	9.975	.055	253,37	0,14	.210	.005	5,33	0,13
4378	10.500	10.875	10-1/2	3/16	10.475	.060	266,07	1,52	.210	.005	5,33	0,13
4379	11.000	11.375	11	3/16	10.975	.060	278,77	1,52	.210	.005	5,33	0,13
4380	11.500	11.875	11-1/2	3/16	11.475	.065	291,47	1,65	.210	.005	5,33	0,13
4381	12.000	12.375	12	3/16	11.975	.065	304,17	1,65	.210	.005	5,33	0,13
4382	13.000	13.375	13	3/16	12.975	.065	329,57	1,65	.210	.005	5,33	0,13
4383	14.000	14.375	14	3/16	13.975	.070	354,97	1,78	.210	.005	5,33	0,13
4384	15.000	15.375	15	3/16	14.975	.070	380,37	1,78	.210	.005	5,33	0,13
4385	16.000	16.375	16	3/16	15.955	.075	405,26	1,91	.210	.005	5,33	0,13
4386	17.000	17.375	17	3/16	16.955	.080	430,66	2,03	.210	.005	5,33	0,13
4387	18.000	18.375	18	3/16	17.955	.085	456,06	2,16	.210	.005	5,33	0,13
4388	19.000	19.375	19	3/16	18.955	.090	481,41	2,29	.210	.005	5,33	0,13
4389	20.000	20.375	20	3/16	19.955	.095	506,81	2,41	.210	.005	5,33	0,13
4390	21.000	21.375	21	3/16	20.955	.095	532,21	2,41	.210	.005	5,33	0,13
4391	22.000	22.375	22	3/16	21.955	.100	557,61	2,54	.210	.005	5,33	0,13
4392	23.000	23.375	23	3/16	22.940	.105	582,68	2,67	.210	.005	5,33	0,13
4393	24.000	24.375	24	3/16	23.940	.110	608,08	2,79	.210	.005	5,33	0,13
4394	25.000	25.375	25	3/16	24.940	.115	633,48	2,92	.210	.005	5,33	0,13
4395	26.000	26.375	26	3/16	25.940	.120	658,88	3,05	.210	.005	5,33	0,13
4425	4.500	5.000	4-1/2	1/4	4.475	.033	113,67	0,84	.275	.006	6,99	0,15
4426	4.625	5.125	4-5/8	1/4	4.600	.033	116,84	0,84	.275	.006	6,99	0,15
4427	4.750	5.250	4-3/4	1/4	4.725	.033	120,02	0,84	.275	.006	6,99	0,15
4428	4.875	5.375	4-7/8	1/4	4.850	.033	123,19	0,84	.275	.006	6,99	0,15

19. B. Precision Quad-Rings®/X-Rings Standard Sizes

Standard Quad-Ring® / X-Ring Sizes

Size Only Part nr.	Nominal Sizes		Actual Sizes									
	Rod	Bore	ID (in)	C/S (in)	ID (in)	+/-	ID(mm)	+/-	C/S (in)	+/-	C/S (mm)	+/-
4429	5.000	5.500	5	1/4	4.975	.037	126,37	0,94	.275	.006	6,99	0,15
4430	5.125	5.625	5-1/8	1/4	5.100	.037	129,54	0,94	.275	.006	6,99	0,15
4431	5.250	5.750	5-1/4	1/4	5.225	.037	132,72	0,94	.275	.006	6,99	0,15
4432	5.375	5.875	5-3/8	1/4	5.350	.037	135,89	0,94	.275	.006	6,99	0,15
4433	5.500	6.000	5-1/2	1/4	5.475	.037	139,07	0,94	.275	.006	6,99	0,15
4434	5.625	6.125	5-5/8	1/4	5.600	.037	142,24	0,94	.275	.006	6,99	0,15
4435	5.750	6.250	5-3/4	1/4	5.725	.037	145,42	0,94	.275	.006	6,99	0,15
4436	5.875	6.375	5-7/8	1/4	5.850	.037	148,59	0,94	.275	.006	6,99	0,15
4437	6.000	6.500	6	1/4	5.975	.037	151,77	0,94	.275	.006	6,99	0,15
4438	6.250	6.750	6-1/4	1/4	6.225	.040	158,12	1,02	.275	.006	6,99	0,15
4439	6.500	7.000	6-1/2	1/4	6.475	.040	164,47	1,02	.275	.006	6,99	0,15
4440	6.750	7.250	6-3/4	1/4	6.725	.040	170,82	1,02	.275	.006	6,99	0,15
4441	7.000	7.500	7	1/4	6.975	.040	177,17	1,02	.275	.006	6,99	0,15
4442	7.250	7.750	7-1/4	1/4	7.225	.045	183,52	1,14	.275	.006	6,99	0,15
4443	7.500	8.000	7-1/2	1/4	7.475	.045	189,87	1,14	.275	.006	6,99	0,15
4444	7.750	8.250	7-3/4	1/4	7.725	.045	196,22	1,14	.275	.006	6,99	0,15
4445	8.000	8.500	8	1/4	7.975	.045	202,57	1,14	.275	.006	6,99	0,15
4446	8.500	9.000	8-1/2	1/4	8.475	.055	215,27	1,40	.275	.006	6,99	0,15
4447	9.000	9.500	9	1/4	8.975	.055	227,97	1,40	.275	.006	6,99	0,15
4448	9.500	10.000	9-1/2	1/4	9.475	.055	240,67	1,40	.275	.006	6,99	0,15
4449	10.000	10.500	10	1/4	9.975	.055	253,37	1,40	.275	.006	6,99	0,15
4450	10.500	11.000	10-1/2	1/4	10.475	.060	266,07	1,52	.275	.006	6,99	0,15
4451	11.000	11.500	11	1/4	10.975	.060	278,77	1,52	.275	.006	6,99	0,15
4452	11.500	12.000	11-1/2	1/4	11.475	.065	291,47	1,52	.275	.006	6,99	0,15
4453	12.000	12.500	12	1/4	11.975	.065	304,17	1,52	.275	.006	6,99	0,15
4454	12.500	13.000	12-1/2	1/4	12.475	.065	316,87	1,52	.275	.006	6,99	0,15
4455	13.000	13.500	13	1/4	12.975	.065	329,57	1,52	.275	.006	6,99	0,15
4456	13.500	14.000	13-1/2	1/4	13.475	.070	342,27	1,78	.275	.006	6,99	0,15
4457	14.000	14.500	14	1/4	13.975	.070	354,97	1,78	.275	.006	6,99	0,15
4458	14.500	15.000	14-1/2	1/4	14.475	.070	367,67	1,78	.275	.006	6,99	0,15
4459	15.000	15.500	15	1/4	14.975	.070	380,37	1,78	.275	.006	6,99	0,15
4460	15.500	16.000	15-1/2	1/4	15.475	.070	393,07	1,78	.275	.006	6,99	0,15
4461	16.000	16.500	16	1/4	15.955	.075	405,26	1,91	.275	.006	6,99	0,15
4462	16.500	17.000	16-1/2	1/4	16.455	.075	417,96	1,91	.275	.006	6,99	0,15
4463	17.000	17.500	17	1/4	16.955	.080	430,66	2,03	.275	.006	6,99	0,15
4464	17.500	18.000	17-1/2	1/4	17.455	.085	443,36	2,16	.275	.006	6,99	0,15
4465	18.000	18.500	18	1/4	17.955	.085	456,06	2,16	.275	.006	6,99	0,15
4466	18.500	19.000	18-1/2	1/4	18.455	.085	468,76	2,16	.275	.006	6,99	0,15
4467	19.000	19.500	19	1/4	18.955	.090	481,46	2,29	.275	.006	6,99	0,15
4468	19.500	20.000	19-1/2	1/4	19.455	.090	494,16	2,29	.275	.006	6,99	0,15
4469	20.000	20.500	20	1/4	19.955	.095	506,86	2,41	.275	.006	6,99	0,15
4470	21.000	21.500	21	1/4	20.955	.095	532,26	2,41	.275	.006	6,99	0,15
4471	22.000	22.500	22	1/4	21.955	.100	557,66	2,54	.275	.006	6,99	0,15
4472	23.000	23.500	23	1/4	22.940	.105	582,68	2,67	.275	.006	6,99	0,15
4473	24.000	24.500	24	1/4	23.940	.110	608,08	2,79	.275	.006	6,99	0,15
4474	25.000	25.500	25	1/4	24.940	.115	633,48	2,92	.275	.006	6,99	0,15
4475	26.000	26.500	26	1/4	25.940	.120	658,88	3,05	.275	.006	6,99	0,15

19. C. Gland design for Rotating Quad-Rings®/X-Rings Applications

As already mentioned, the rotating speed of > 100 feet/mn (30m/min.) is critical. It is recommended to use radial lip seals like oil and grease shaft seals or PS-seals. However the compact installation of Quad-Rings®/X-Rings with the roto principle can be used instead. It is expected that the shaft rotates in the stationary Quad-Ring®/X-Rings.

The next points need to be taken into consideration:

- The Gow-Joule effect. The Quad-Ring®/X-Ring should not be installed in a stretched position around the shaft. The inner diameter of the Quad-Ring®/X-Ring needs to be 2-5% larger than the diameter of the shaft.
- Do not install the Quad-Ring®/X-Ring in a groove in the shaft. It can happen that the Quad-Ring®/X-Ring will rotate with the shaft.
- Avoid applications with temperatures lower than -30°C or higher than $+100^{\circ}\text{C}$ (-22°F or higher than $+212^{\circ}\text{F}$).
- Rotation speeds need to be limited to 6.5 ft/s (2m/sec.) and pressures to 150 psi (10 bar, 1 MPa).
- For higher pressures, up to 450 psi (30 bar, 3MPa) back-up rings must be used.
- Up to a diameter of 4 inches (100 mm), the cross section of the Quad-Ring®/X-Ring needs to be limited on sizes .103 to .210 inch (2,62 to 5,33 mm). For larger shaft diameters >4 inches (>100 mm), the cross section of the Quad-Ring®/X-Ring has to be at least .275 inch (6,99 mm).
- The surface finish of the groove always has to be rougher than the surface finish of the shaft to avoid spinning.
- Lubrication of the Quad-Ring®/X-Ring reduces the frictional force, keeps the seal cool, and reduces the tendency of the seal to harden.
- It is very important that the shaft construction have good bearings.
- For rotating application always use Quad-Rings®/X-Rings in 80 or 90 Shore A.

Surface Finish: X

Groove top and bottom X= 16 micro inches (0,4 μm Ra)

Groove sides X= 32 micro inches (0,8 μm Ra)

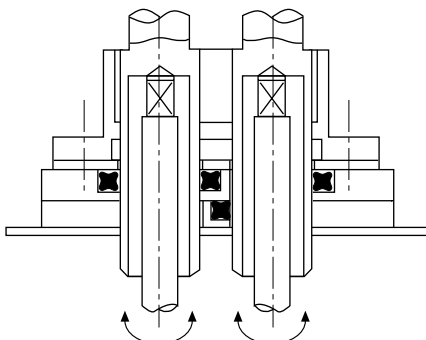

Ask for the ERIKS
information on
rotating
Quad-Ring®/X-Ring
applications!